

# **FUTURE SHIP POWERING OPTIONS**

Exploring alternative methods  
of ship propulsion

July 2013



# Contents

<b>Foreword</b>	2	<b>Glossary</b>	76
<b>Executive summary</b>	3	<b>References</b>	77
<b>1. Introduction</b>	8	<b>Appendices</b>	78
1.1 Drivers for change	9	1. Terms of reference	78
1.1.1 Carbon emissions	9	2. Membership of the working group	79
1.1.2 Price of oil	10	3. Referee and review group	81
1.2 The shipping industry	11	4. Statement from Vice-President of the European Commission Siim Kallas and EU Commissioner for Climate Action Connie Hedegaard, October 2012	82
1.2.1 Technical development	11	5. A ship systems approach	83
1.2.2 Operation	13	6. Further aspects relating to nuclear merchant ship propulsion	84
1.3 International regulations	15	7. International atomic energy principles and requirements	89
1.3.1 Emissions control under MARPOL Annex VI	16	8. The energy efficiency design index	92
1.4 Global context of shipping	17	9. Calendar for main emission legislation events 2010–2020	93
		10. Potential applicability of measures and options discussed	94
<b>2. Design options</b>	18		
2.1 Ship energy considerations	18		
2.2 The ship system	19		
2.3 Energy Efficiency Design Index	20		
<b>3. Primary propulsion options</b>	22		
Conventional propulsion options and fuels			
3.1 Diesel engines	22		
3.2 Biofuels	26		
3.3 Liquid natural gas (LNG)	29		
3.4 Gas turbines	31		
Other propulsion technology options			
3.5 Nuclear	33		
3.6 Batteries	41		
3.7 Fuel cells	43		
3.8 Renewable energy sources	47		
3.9 Hydrogen	50		
3.10 Anhydrous ammonia	51		
3.11 Compressed air and liquid nitrogen	51		
3.12 Hybrid propulsion	53		
<b>4. Further Propulsion Considerations</b>	54		
4.1 Propulsors	54		
4.2 Energy-saving devices	60		
4.3 Hull design and appendages	62		
4.4 Hull coatings	62		
4.5 Superconducting electric motors	64		
4.6 Ship operational considerations	66		
4.6.1 Operational profile	66		
4.6.2 Weather routing	66		
4.6.3 Plant operational practices	66		
<b>5. Time frame for technical development</b>	68		
<b>6. Conclusions</b>	70		



# Foreword



Photo by Carmel King

Shipping is vital to the world economy. It is a critical part of international import and export markets and supports the global distribution of goods. As for all industries, concerns about climate change require the reduction of greenhouse gas emissions from the shipping sector. This entails higher fuel prices for low sulphur fuels. It means that the industry must prepare for the new future and investigate alternative, more economic ship propulsion systems.

This report, prepared by an expert working group at the Royal Academy of Engineering, gives a fascinating insight into the development of ship propulsion systems. It sets out how we got to the current technological solutions and examines a wide range of possibilities for future ship powering options. The report presents a thorough review of the range of technologies, and examines the advantages and limitations of systems from solar and wind power, through fuel cells to nuclear propulsion.

I believe that this report will be of great benefit to the shipping industry, offering an overview that is both broad and expertly informed. I hope that it is made full use of as this important sector joins the challenge to reduce emissions on a global scale and maintain its competitiveness.

Sir John Parker GBE FREng  
President of the Royal Academy of Engineering

# Executive summary

## TO ACHIEVE EFFECTIVE IMPROVEMENTS IN EFFICIENCY AND REDUCTIONS IN EMISSIONS FOR SHIPS, AN INTEGRATED SYSTEMS ENGINEERING APPROACH IS REQUIRED

International agreements on the need to combat climate change, the fluctuating but generally rising costs of marine fuels which account for a large proportion of the running costs of a ship, and developments on a number of other fronts have led many in the industry to question whether the present methods of ship propulsion are sustainable. These concerns are enhanced by the introduction of environmental regulations intended to reduce the impact of climate change – primarily MARPOL Annex VI and the Energy Efficiency Design Index regulations together with the possible introduction of carbon taxes.

This report embraces a number of conventional propulsion methods and fuels and also addresses the newer options of biofuels, liquid natural gas and hydrogen. In the case of other propulsion options, the subjects of nuclear propulsion, alternative fuels, batteries, fuel cells, renewable energy, superconducting electric motors and hybrid propulsion are considered. Additional propulsion influences are addressed and include conventional and non-conventional propulsors, magnetohydrodynamic propulsion, energy-saving devices, hull design and coatings.

There are other factors that affect the emissions from shipping. Avoiding poor weather by using weather-routing technologies offers important fuel consumption benefits. Similar benefits are also realisable if ship speed is optimised during voyages and the crew are trained to understand the implications of the decisions and actions they take. Furthermore, the condition of a ship's machinery has a significant influence on fuel consumption and emissions performance. There is, therefore, good reason to keep machinery well-maintained and operated by well-motivated crews.

Studies show that larger ships are more carbon-efficient than smaller vessels, and it is known that deploying slower ship speeds is an effective means of reducing emissions. However, de-rating existing engines installed in ships, or fitting smaller engines than are conventionally adopted for a given ship size in order to meet environmental design constraints, can create significant operational risks from under-powering ships, particularly in poor weather.

**THE DIESEL ENGINE IS CURRENTLY THE MOST WIDESPREAD OF MARINE PRIME MOVERS. IT IS A WELL-UNDERSTOOD TECHNOLOGY AND A RELIABLE FORM OF MARINE PROPULSION AND AUXILIARY POWER GENERATION, WITH ENGINE MANUFACTURERS HAVING WELL-ESTABLISHED REPAIR AND SPARE PART NETWORKS AROUND THE WORLD**

To achieve effective improvements in efficiency and reductions in emissions for ships, an integrated systems engineering approach is required. This must embrace all of the elements of naval architecture, marine and control engineering alongside operation practices. Moreover, a systems approach must include all of the stakeholder requirements to achieve a sustainable and optimal design solution. With any propulsion option it is essential that the overall emission profile of the propulsion method and the fuel used is properly assessed, so that reductions in exhaust emissions from ships are not at the cost of increasing harmful emissions in land-based sectors that produce either the propulsion machinery or the fuel.

The report identifies a range of short-, medium- and long-term propulsion options:

**Short-term options**

The diesel engine is currently the most widespread of marine prime movers. It is a well-understood technology and a reliable form of marine propulsion and auxiliary power generation, with engine manufacturers having well-established repair and spare part networks around the world. In addition, there is a supply of trained engineers and the education requirements for future engineers are well-understood, with appropriate training facilities available. However, diesel engines will continue to produce CO<sub>2</sub> emissions as well as NO<sub>x</sub>, SO<sub>x</sub>, volatile organic compounds and particulate matter.

Liquid natural gas (LNG) can be used in reciprocating engine propulsion systems and is a known technology with classification society rules for the fuel systems already in existence. Service experience with dual fuel and converted diesel engines, although limited at the present time, has been satisfactory and currently LNG is considerably cheaper than conventional fuels. LNG, while not free of harmful emissions, has benefits in terms of CO<sub>2</sub>, NO<sub>x</sub>, SO<sub>x</sub> emissions, given that methane slip is avoided during the combustion and fuelling processes.

Gas turbines have been successfully used in niche areas of the marine market and represent a proven high power density propulsion technology. However, the fuel for aero-derivative gas turbines is expensive when compared to conventional marine fuels and gas turbine thermal efficiencies are lower than for slow-speed diesel engines of similar power.

Renewable energy, principally derived from wind and solar origins, is considered as an augment to the main propulsion and auxiliary power requirements of a ship.

**Medium- to long-term options**

Biofuels are potential medium-term alternatives to conventional fuels for diesel engines. Synthetic fuels based on branch-chain higher alcohols and new types of E-coli as well as algae and other microorganisms are medium- to long-term possibilities, but further work is necessary to examine their storage, handling, and impacts on health, safety and the environment. Di-methyl ether shows some potential as an alternative fuel; however, there are presently disadvantages which need resolution in terms of lubricity and corrosion together with the creation of sufficient production and supply networks.

Fuel cells offer potential for ship propulsion with good experience gained in auxiliary and low-power propulsion machinery. For marine propulsion, the high-temperature solid oxide and molten carbonate fuel cells show most promise, while for lower powers the low temperature proton exchange membrane fuel cells are more suitable. While hydrogen is the easiest fuel to use in fuel cells, this would require a worldwide infrastructure to be developed for supply to ships.

Nuclear ship propulsion has the advantage during operation of producing no CO<sub>2</sub>, NO<sub>x</sub>, SO<sub>x</sub>, volatile organic or particulate emissions. A significant body of experience exists in the design and safe operation of shipboard nuclear propulsion plant, particularly in the case of PWR designs. The conventional methods of design, planning, building and operation of merchant ships would, however, need a complete overhaul since the process would be driven by a safety case and systems engineering approach. Issues would also need to be addressed in terms of international regulation, public perception and acceptability, financing the initial capital cost, training and retention of crews, setting up and maintenance of a global infrastructure support system, insurance and nuclear emergency response plans for ports.

Battery technology is developing rapidly, offering some potential for propulsion. However, full ship battery propulsion requires further technical development and is likely to be confined to relatively small ships. Nevertheless, battery-based propulsion would be beneficial due to producing no CO<sub>2</sub>, NO<sub>x</sub>, SO<sub>x</sub>, volatile organic or particulate emissions in operation. Batteries may offer a potential hybrid solution in conjunction with other modes of propulsion for some small- to medium-sized ships provided that their recharging does not increase the production of other harmful emissions from land-based sources or elsewhere.

Superconducting electric motor technology has been successfully used in demonstrator applications, with low electrical losses resulting in a more efficient motor. Depending upon the type of prime mover deployed, exhaust emissions will be lower, the machine can run for some time after a coolant failure, and further advantages may accrue from their smaller size.

TO DEVELOP FUTURE SHIP PROPULSION SYSTEMS WITHIN REASONABLE TIMESCALES, RESEARCH AND FUNDING ARE NEEDED IN A NUMBER OF AREAS

Hydrogen, compressed air and liquid nitrogen are likely to be long-term propulsion considerations. While the latter two options are energy storage media, hydrogen is a fuel which generates no CO<sub>2</sub> or SO<sub>x</sub> emissions to the atmosphere and would use land-based sources of power for its creation. It would need a supply infrastructure to be viable in a marine context, but it is ideal for use in fuel cells. Compressed air and nitrogen would use land-based sources of power for creation and the tank storage technologies are well understood - though tank corrosion is an issue in salt-laden environments. The size, pressure rating and cryogenic capabilities, in the case of liquid nitrogen, of the ship storage tanks will determine the amount of energy storage and hence usefulness of the concept. As with hydrogen, a supply and infrastructure and distribution network would be needed.

**In summary, the following options are considered appropriate:**

- i. For existing ships, reciprocating engines with exhaust gas attenuation technologies are the principal option together with fuels that produce fewer CO<sub>2</sub> emissions. LNG is one such fuel and, together with some other alternatives, would require an adequate bunkering infrastructure to be developed, particularly for deep sea voyages. Some attention could also be usefully paid to reducing the demand for shipboard energy.
- ii. For new buildings planned in the near-term, the scenario is broadly similar but with the option to include hybrid propulsion systems depending on ship size and intended use.
- iii. In the case of ships to be built in the medium- to long-term, further propulsion options include alternative fuel options, fuel cells, batteries and nuclear. The former methods await technological development but nuclear, while well understood technically, would require a major change to ship owning and operation infrastructure and practices.

Renewable power sources such as wind and solar are likely to be augmented to power requirements, assuming a return to full sail propulsion is not contemplated. If, in the future, a hydrogen economy is adopted, then hydrogen may become a realistic marine fuel option.

To develop future ship propulsion systems within reasonable timescales, research and funding are needed in a number of areas: fuel cells capable of sustainable powers for ship propulsion; modular nuclear reactors; hull form and skin friction reduction measures; ship operational methodologies and perhaps high capability batteries and hydrogen generation. There is also a need for further soundly based techno-economic studies on target emissions from ships.



# 1. Introduction

## INTERNATIONAL SHIPPING IS ESTIMATED TO CONTRIBUTE SOME 3% OF GLOBAL EMISSIONS OF CO<sub>2</sub>

The propulsion of merchant shipping has, during the last century, undergone a significant transformation. It is now dominated by diesel propulsion machinery with the cost of fuel accounting for a large proportion of the running costs of the ship. Against this background, recent developments have led many in the industry to question whether the present modes of ship propulsion are sustainable due to three main factors:

- Rising fuel costs as a result of the escalating price of oil.
- Environmental regulations introduced to mitigate the effects of climate change.
- The potential introduction of carbon taxes.

Within the wider international debate on climate change there are increasing calls for shipping to reduce emissions of greenhouse gases, most notably carbon dioxide although other exhaust gases components

are also included. International shipping is estimated to contribute some 3% of global emissions of CO<sub>2</sub> and this, if no attenuating action is implemented, will vary as the shipping industry changes to reflect world trade. Although the industry has reduced its consumption of fossil fuels by, for example, employing increasingly thermally efficient diesel engines in recent decades, the current total fuel oil consumption is in excess of 350 million tonnes per annum.

At present some 95% of the world's goods are moved by sea. Furthermore, Figure 1.1 (Stopford, 2012) underlines generally increasing trends in cargo growth with only small perturbations that have coincided with world financial or political difficulties. This trend of increasing shipping activity is forecast to increase further in a recent IMO study. Additionally, it can be seen that, in 2011, the oil and the bulk transport trades respectively accounted for 28% and 39%

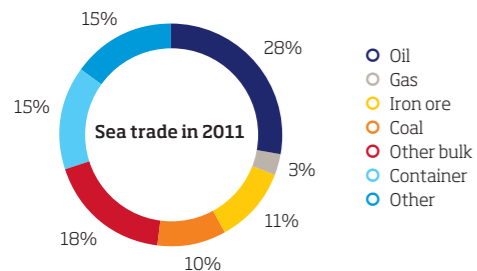
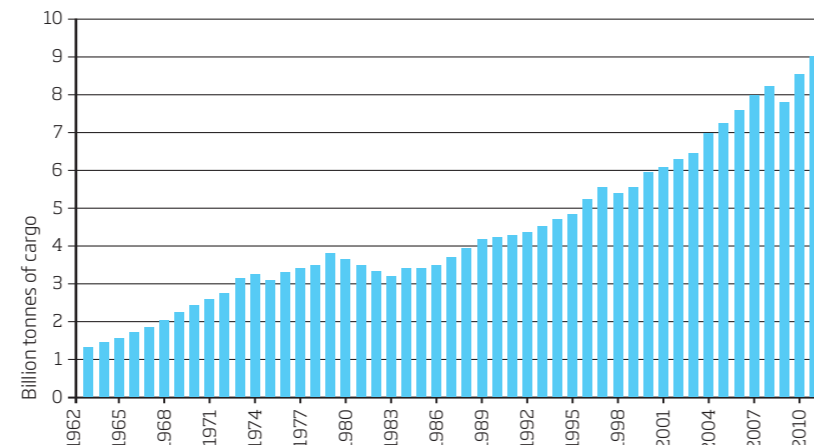

Figure 1.1 The trend in cargo growth 1962 to 2011 [Stopford 2012]



of the total sea trade in terms of the weight of cargo transported, while container shipping was around 15%.

The carriage of freight by sea is low-cost. Consequently, because the transport costs are low the international community is not generally aware of shipping economics. Within the shipping industry, however, competition for trade between companies is strong and there are four elements which have a significant influence on shipping economics. These are the freight; the shipbuilding; the sale and purchase; and the scrapping markets. Freight rates are largely a function of the available transport capacity any political intervention and world trade levels where these are all variables. There are also components of the derivative, voyage charter and time-charter markets and it is all of these component aspects which generate cash for the shipping industry. The shipbuilding market produces new ships for the industry at agreed prices and thereby takes cash out of the industry in return for ships to be delivered at some time in the future, typically in two or three years. In contrast, the sale and purchase market moves cash between shipping companies while the demolition market generates a small income when ships are scrapped.

The cyclic nature of economic prosperity in the shipping industry has been a characteristic of the industry for many years. While the design life of a ship is normally about 25 years, when freight rates are low many younger ships may become due for scrapping since they are relatively inefficient and generally unfit for profit generation. As such, the remaining value of these ships has to be written off company balance sheets. Consequently, under those conditions, while there is an appetite within the industry for innovation, there are also reservations about the risks associated with innovation in alternative propulsion methods.

In the wider context, a recent report by the Royal Society recommended that

*“The most developed and the emerging economies must stabilise and then reduce material consumption levels through: dramatic improvements in resource use efficiency, including: reducing waste; investment in sustainable resources, technologies and infrastructures; and systematically decoupling economic activity from environmental impact.”* (Royal Society, 2012)

To lay a foundation for the consideration of alternative means of propulsion of merchant ships, the Royal Academy of Engineering convened a working group in July 2010, (Appendices 1, 2 and 3), to consider the issues involved and this report summarises the findings. It principally considers the technical and regulatory issues relating to the options and aims to place these into short-, medium- and long-term perspectives.

## 1.1 Drivers for change

### 1.1.1 Carbon emissions

The Kyoto Protocol under Article 2.2 stated that *“the Parties included in Annex I shall pursue limitation or reduction of emissions of greenhouse gas emissions not controlled by the Montreal Protocol from aviation and marine bunker fuels, working through the International Civil Aviation Organization (ICAO) and the International Maritime Organization (IMO), respectively.”*. Work has continued on this aspect under the Subsidiary Body for Scientific and Technological Advice and the Subsidiary Body for Implementation although firm agreements are yet to be reached.

Failure to reach agreement at the international level has prompted individual nations or groups of nations to consider the issue. The European Union, under the European Climate Change Programme II, is carrying out a consultation on options to include shipping in its overall commitments to greenhouse gas reduction. It has welcomed the introduction of the Energy

Efficiency Design Index (EEDI) developed within the IMO forum and sees monitoring emissions as the first step in controlling emissions. However, it is clearly intent on pushing forward with actual reductions (Appendix 4).

The United Kingdom legally enshrined greenhouse gas emission reduction targets under the 2008 Climate Change Act: 80% reductions relative to 1990 levels by 2050 with interim budgets specified up to that date. Currently, aviation and shipping are not included in these targets. However, the Committee for Climate Change, an independent statutory body set up to advise government on setting and meeting the carbon budgets, have concluded that there is no reason to treat shipping any differently from other sectors. Specifically, they recommend that:

- International shipping emissions should be added at around 9 MtCO<sub>2</sub>e per year, based on a projection of UK emissions which reflects current international policy; that is, the EEDI adopted by the International Maritime Organisation.
- Non-Kyoto climate effects of aviation, for example contrails and induced cirrus, and shipping should be further researched, closely monitored and reduced where possible, but not included in carbon budgets.

### 1.1.2 Price of oil

While air- and water-related emissions already influence the design and operation of ships, of more immediate concern to ship operators is the current and future price of oil. With fuel costs accounting for as much as 50 to 60% of total operating costs, rises in bunker fuel prices have implications for ship operating economics and margins. Within this scenario the *level playing field* concept, cherished by ship operators, is an essential aspect of shipping commerce.

Historically, the bunker prices of marine fuels have fluctuated significantly and Figure 1.2 shows the changes for 380 cSt marine fuel over the last 20 years. Furthermore, these fluctuations are reflected in the various markets around the world and there are similar trends observable between the different grades of fuel. Over the same period, crude oil prices (BP 2012) have shown similar general trends in price fluctuation; however, when viewed in a longer time frame major global events, such as World War II, do not appear to have had a significant effect. Consequently, over the last two decades bunker prices have been showing an increasing mean trend together with large fluctuations about the mean trend.

Recognising that oil is ultimately a finite resource, there have been repeated

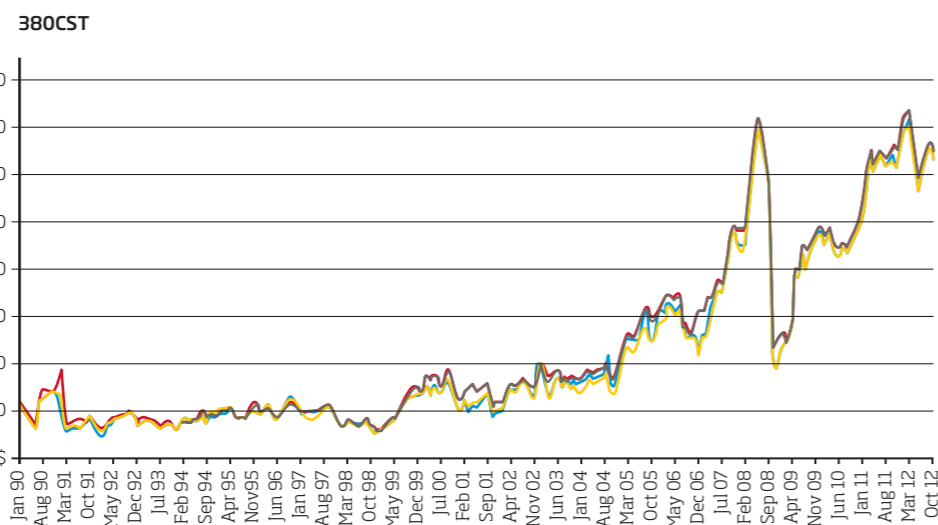

Figure 1.2 Historical bunker prices for 380 cSt marine fuel [Platts]

## THE 18TH AND 19TH CENTURIES WERE TIMES OF INNOVATION, NOT JUST IN HULL FORM, STRUCTURE AND SAIL DESIGN BUT ALSO IN MATTERS OF SHIP PERFORMANCE

concerns over the years that supplies are dwindling and that production may one day fail to meet demand. This concept is known as *peak oil*. With demand growing, especially in developing nations, and the apparent rate of discovery of new oil fields dropping, the prospect of a global peak in oil production has led some to speculate that the price of oil will rise significantly in the future.

Proven oil reserves relative to current demand have remained relatively constant for many years (BP 2012) due mainly to better methods of identifying prospective fields as well as the opening up of previously uneconomic fields. This has been made possible by advanced drilling techniques which have now become economic because prices have increased. Furthermore, the price of oil appears to have a relationship with the activities of global finance markets as well as on the fundamentals of supply and demand; something that world governments, led by the US, are attempting to control.

Increases in the use of natural gas are also influential in that liquefied natural gas (LNG) has become a global commodity supplying industry and the domestic market. The supply is supplemented by unconventional types of petroleum, particularly shale gas in the US and tar sands in Canada, which are opening up new resources of hydrocarbons and demonstrating that many years will pass before the world runs out of this energy source. It remains to be seen, however, as to whether these sources can be extracted at a sufficient rate and price to satisfy global demand. Furthermore, concerns have been expressed about the extraction procedures on the surrounding environment and, in the case of the United Kingdom, a recent report (Royal Society and Royal Academy of Engineering, 2012) has reviewed the hydraulic fracturing processes involved. It concluded that the risks associated with the extraction of shale gas can be managed effectively as long as operational best practices are implemented and robustly enforced through regulation.

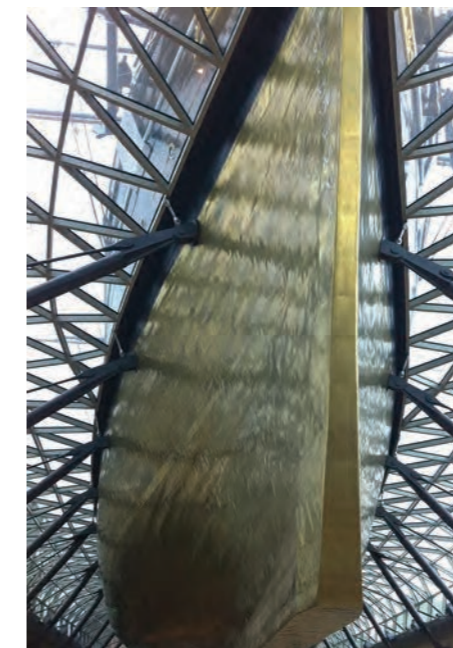

Figure 1.3 Copper sheathing on the hull of the Cutty Sark [Courtesy J.Hensher]

At present and for the foreseeable future predictions of the future price of fuel will remain uncertain and financing shipboard fuel supplies is the responsibility of ship operators to exercise judgement and the necessity for hedging arrangements. Clearly, if at some time in the future the price of oil was to decrease, then the attractiveness of alternative means of propulsion from a purely operational viewpoint would wane. However, within the wider context of a likely increasing demand for seaborne transport and reductions in land-based emissions, marine emissions require some attention.

## 1.2 The Shipping industry

### 1.2.1 Technical development

The evolution of ships and their trade routes has a long history, almost as long as that of mankind. This development of merchant ships witnessed a gradual progression from relatively small and simple sail-powered ships in earlier centuries through to the larger and more complex fast clipper ships in the latter part of the 19th Century: some of these, under favourable conditions, being able to attain speeds of the order of 20 knots. Then as coaling stations became more plentiful around the globe, steamships started to make their appearance and increased in numbers.

The 18th and 19th centuries were times of innovation, not just in hull form, structure and sail design but also in matters of ship performance. For example, the introduction in 1761 of copper hull sheathing on *HMS Alarm* (Lambert 2008), initially to prevent attacks on the hull by ship-boring molluscs, showed significant benefit in fouling prevention and hence propulsion efficiency. Figure 1.3 shows a subsequent development of this in relation to one of the later tea clippers, the *Cutty Sark*.



Figure 1.4 *ss Turbinia*  
[Courtesy J.S. Carlton]

In parallel with sail propulsion, the pace of mechanical and hydrodynamic propulsion development increased rapidly during the 18th and 19th centuries (Pomeroy 2010). These advances began with the steam engine which, at that time, comprised elementary boilers supplying reciprocating engines; for example, Jonathan Hull's patent involving a Newcomen Steam engine in 1736. Steam-based propulsion technology progressed to embrace the technical advances developed by James Watt which led to the *Savannah* in 1819 being powered by a steam engine driving paddle wheels. Towards the end of the 19th century the steam turbine was adopted, initially demonstrated by Sir Charles Parsons in his celebrated vessel *Turbinia* at the Spithead fleet review of 1897; (Figure 1.4). This single event was to totally change ship propulsion since it heralded the end of steam reciprocating marine machinery in favour of the steam turbine.

Only nine years later, in 1906, the *rms Mauritania* was launched and was propelled by steam turbines developing 76,000 shp together with screw propulsion. Figure 1.5 gives some impression of the development which took place during that period in terms of the sizes of the two ships and the installed power of their machinery. Eight years later, the *Transylvania* became the first ship to use geared steam turbines to improve propulsive efficiency.

In parallel with the arrival of the steam turbine, Rudolf Diesel, in 1892, took out a patent and ran his first reciprocating engine

one year later. This line of development paved the way for a small oil tanker, the *Vulcanus*, to become the first ship to be propelled by a diesel engine. It was followed by a much larger ocean-going cargo ship, the *Selandia* in 1912. About this time, the first gas-powered ship *Holzapfel 1* also entered service. However, such was the growth of diesel propulsion that by 1939 some 54% of the fleet was powered in this way. The performance of diesel engines has progressively improved, demonstrated by a comparison of the thermal efficiency for these early engines in current operation, when thermal efficiency has risen to values approaching 55% for slow speed engines.

The burning of heavy fuel was introduced in the 1930s. Research started (Lamb 1948) during the Second World War for its use in marine diesel engines and it has become the standard fuel for the majority of seagoing ships today. Recently, however, local and international legislation has begun to be formulated and the focus is moving to the more expensive lighter marine fuels and the use of dual-fuelled engines. With these engines, different grades of fuel are burnt depending upon the prevailing requirements within the emission zones. In recent years, increasing oil prices have prompted interest in alternative propulsion options and changes in fuels for merchant ships. Typical of these have been the burning of LNG in reciprocating engines, wind-assisted propulsion, ducted propellers, energy-saving appendages and interest in nuclear power.



Figure 1.5 *rms Mauritania* on the River Tyne  
© Tyne Wear Archives Museum



Figure 1.8 Medium-sized cruise ship [Courtesy A. Greig]



Figure 1.6 Offshore supply ship  
© Andrew Mackinnon



Figure 1.7 A large LNG carrier  
© Mercator Media 2013

Gas turbines made their appearance in naval ships as a method of marine propulsion, particularly for high-speed and sprint modes of operation. For naval propulsion the gas turbines were marinised versions of aero-engines. Subsequently, however, for commercial ships, as well as the aero derivatives, the industrial gas turbine found favour in certain sectors of the industry due to its relative robustness in terms of operation and fuel usage.

Today the steam turbine has very largely given way to the diesel engine. This transition happened relatively quickly and coincided with the breakthrough of turbocharging and heavy fuel burning in slow speed diesel engines which gave these engines both the power and the fuel economy to become more efficient than steam turbine propulsion. Consequently, steam turbines are normally only found today in nuclear powered ships and submarines as well as some LNG ships; although in this latter case they are also giving way to reciprocating machinery. In the merchant sector the general demise of steam plant has, in turn, led to a shortage of qualified steam plant operators.

Developments with cruise ship technology have led to the use of diesel-electric propulsion arrangements. This is due to endeavouring to achieve low noise and vibration signatures, similar to steam turbine-driven ships, combined with the enhanced operational efficiency that is achievable with this mode of propulsion by utilising payoffs between propulsion and hotel loadings.

### 1.2.2 Operation

Merchant ships are commonly designed and built to one-off designs or in small batches to suit the trade in which they are engaged: this implies that, unlike the automotive or aircraft industries, prototype testing is not generally feasible. Cargo ships embrace a range of types from large crude oil tankers making long international voyages to small cargo vessels port-hopping around a coast. The nature of their trade varies: the *liner* follows fixed routes carrying cargoes, these days often in containers, while other ships wander the globe picking up cargoes where they can. These so-called *tramp* ships may carry bulk cargoes of grain, cement, iron ore or coal and may be fitted with deck cranes which render them independent of port facilities. In contrast, some ships have a specialist function which might be servicing offshore oil or wind farm facilities, (Figure 1.6); short sea, roll-on/roll-off ferries; natural gas (LNG) carriers, (Figure 1.7); refrigerated carriers of food or cruise ships acting as holiday destinations, (Figure 1.8).

Each ship type has evolved specialised hull and machinery forms which are adapted to their trading requirements. Consequently, innovative technologies are rarely suitable for general application to all ships and a careful selection must be made based on the ship's characteristics, available crew skills and the desired operational profile of the ship.

The ownership of shipping assets is frequently complex. It would not be unusual for a ship to be built in China, using investment finance raised in Singapore, for an owner based in Athens who then devolves operational responsibility to a management company situated in Monaco.



Such an arrangement might involve a charterer in South America shipping goods from the USA to Germany. The ship in question could very possibly be registered in the Bahamas and thus be subjected to the laws of that country. In this example the Bahamas is the vessel's *flag state* while the United States and Germany are, for the period of the ship's stay in harbours there, referred to as *port states*.

Based on gross tonnage, at the end of 2011 Panama and Liberia were the two largest flag states and in terms of ship numbers this amounted to 12%, and 5% respectively of the world's cargo-carrying merchant fleet over 100 GT. The United Kingdom, in 12th place, on the same basis accounted for 1.2%. If analysed in terms of the nationality of the owner for ships over 1,000 GT, Japan and Greece dominate with the United Kingdom in 6th place (IHS Fairplay, 2011).

The marine industry has generally been cautious in its approach to technology in all but a few sectors. This is for many reasons, including the use of new technologies in an extremely hostile environment. The cyclic economic nature of world trading and its consequent influence on the finances of shipping companies, together with the constantly changing international political scenarios under which the industry has to work are also contributing factors. Within

this environment, innovative technologies should not be considered in a single-country sense or even in a Euro-centric way. Many factors influence the take-up of ideas and technologies in the marine industry which include their initial cost and the commercial relationships between the shipyards, shipowners and the innovators as well as the political aspirations of nations. It is, therefore, essential for the marine industry to take a global perspective on these matters.

At the end of 2011, the total world fleet, having individual deadweight tonnage in excess of 100GT, comprised 104,305 ships (IHS Fairplay, 2011) of which the cargo carrying fleet accounted for 55,138 ships and represented a total deadweight of 1,483.1 Mdw. During that year, 2,609 ships were completed while 1,412 were either disposed of or, in some cases, lost. This difference represented a net gain in world tonnage of 121.5 Mdw and the average age of the fleet was 19 years.

The composition of the cargo-carrying fleet based on deadweight is shown by Table 1.1. On this basis it is seen that tankers and bulk carriers account for 78% of the world fleet. Next in significance as a sector is the container fleet which amounts to a further 13%. These three ship types account for 91% of the world cargo-carrying fleet.

Ship Type	Proportion of the cargo-carrying fleet (%)	Sub-class	Sub-class proportion of cargo-carrying fleet (%)
Tanker	37	Crude oil carriers	24
		Chemical tankers	6
		LNG carriers	2
		Products tankers	4
		LPG tankers	1
Bulk carriers	41	Dry bulk	40
		Self discharging dry bulk	<1
		Dry bulk/oil	<1
		Other dry bulk types	<1
Container	13		
General & refrigerated cargo	6		
Ro/Ro and Ro/Pax	2		
Cruise and passenger	<1		
Miscellaneous	<1		

Table 1.1 Composition of the world cargo fleet (over 100 Dwt) based on dwt [(IHS Fairplay (2011))]

## THE IMO'S INTERNATIONAL SAFETY MANAGEMENT (ISM) CODE PROVIDES AN INTERNATIONAL STANDARD FOR THE SAFE MANAGEMENT AND OPERATION OF SHIPS AND FOR POLLUTION PREVENTION

### 1.3 International regulations

The international maritime community operates in territorial and international waters across the globe and requires a regulatory regime which can properly serve this level of international complexity. The International Maritime Organisation, based in London, is a limb of the United Nations and provides this forum together with a secretariat for flag state governments. In this forum, observed by other interested parties, suites of regulations are agreed, revised and published as *Conventions* and when ratified, implemented by states in national laws which then apply to ships flying their flags. Frequently, IMO rules are made retrospective to an incident and the attainment of international agreement may involve protracted implementation timescales in order to satisfy the concerns of nations.

The IMO Conventions most relevant to this report are:

- **Safety of Life at Sea Convention (SOLAS)** has a broad coverage from the safety aspects of ship structural construction, stability and fire protection through to safety management and navigation rules. SOLAS is the cornerstone of international maritime safety requirements, having been initiated as a result of the Titanic disaster and built upon over time so that today it has become a comprehensive safety document.
- **Prevention of Marine Pollution Convention (MARPOL)** applies principally to the protection of the marine environment and embraces contamination by oil, chemical spills, sewage, marine species, garbage and air pollution by engine exhaust gases. The requirements are stringent and national penalties for non-compliance often severe. A recent focus has been on addressing the international community's concerns about climate

change and commercial shipping's contribution to pollution levels.

- **Standards of Training, Certification and Watchkeeping (STCW)** sets standards for the training for seafarer skills and qualifications. These are reflected in the certificates of competency acquired by merchant navy officers as they progress up the promotional ladder towards Master and Chief Engineer.

In addition to these conventions, the IMO's International Safety Management (ISM) Code provides an international standard for the safe management and operation of ships and for pollution prevention.

The responsibility for governmental application of IMO's international rules in the United Kingdom rests with the Maritime and Coastguard Agency, which is a limb of the Department for Transport. This agency employs technical expertise commensurate with this role and represents the UK in several international maritime fora. Its surveyors provide enforcement of regulations on UK-flagged ships and constitute a port state control inspectorate for regulation compliance by visiting ships.

The contraction of the European commercial shipbuilding and marine engineering industries has led to a refocusing of technical activity in these fields. Besides that which exists in the navies and some shipyards specialising in complex ships, the principal repository of naval architectural and marine engineering knowledge largely rests with the principal classification societies together with some major consultancy organisations, universities and the professional learned societies. The classification societies have progressively developed standards for ships' hull and machinery design, construction and repair based on programmes of continuing research combined with accumulated experience of shipbuilding and service operation. The once pre-eminent technical position of

# SHIPS COMPARE WELL IN CO<sub>2</sub> EMISSION TERMS WITH OTHER FORMS OF TRANSPORT

British and European shipbuilding and repair acted as the foundation for much of this knowledge. However, these activities have either transferred or are in the process of transferring to other geographical locations; chiefly to the Far East. Nevertheless, the major classification societies have offices in these newer centres of activity which enables these technical knowledge repositories to be continually enhanced.

### 1.3.1 Emissions control under MARPOL Annex VI

During the 1990s, attention to air pollution and global warming led to regulations restricting the emission of the oxides of nitrogen (NO<sub>x</sub>) and sulphur (SO<sub>x</sub>): pollutants produced during combustion in diesel engine cylinders. Subsequent amendments have included restrictions on the emissions of ozone, particulate matter and greenhouse gases.

The MARPOL Annex VI NO<sub>x</sub> emission standards are arranged in three tiers: Tiers I, II and III. The Tier I standards were defined in the 1997 version of the Annex, while the Tier II/III standards were introduced by amendments adopted in 2008, as follows:

- 1997 Protocol (Tier I) - The 1997 Protocol to MARPOL, which includes Annex VI, became effective on 18 May 2004 when Annex VI was ratified by

states with 54.6% of world merchant shipping tonnage. Accordingly, Annex VI entered into force on 19 May 2005. It applied retrospectively to new engines of greater than 130 kW installed on vessels constructed on or after 1st January 2000, or which underwent a major conversion after that date. In anticipation of the Annex VI ratification, most marine engine manufacturers have been building engines compliant with the above standards since 2000.

- 2008 Amendments (Tier II/III) - Annex VI amendments adopted in October 2008 introduced new fuel quality requirements which commenced in July 2010; Tier II and III NO<sub>x</sub> emission standards for new engines; and Tier I NO<sub>x</sub> requirements for existing pre-2000 engines. The revised Annex VI entered into force on 1 July 2010. By October 2008, Annex VI was ratified by 53 countries, including the United States, which represented 81.9% of tonnage.

The NO<sub>x</sub> limits apply globally, whereas at this time the SO<sub>x</sub> emissions requirements of Annex VI vary depending on where the ship is sailing. More stringent emission levels for SO<sub>x</sub> apply in certain Emission Control Areas. Currently there are four ECAs located in the Baltic Sea, North Sea, around North America and the US Caribbean as seen in Figure 1.9.

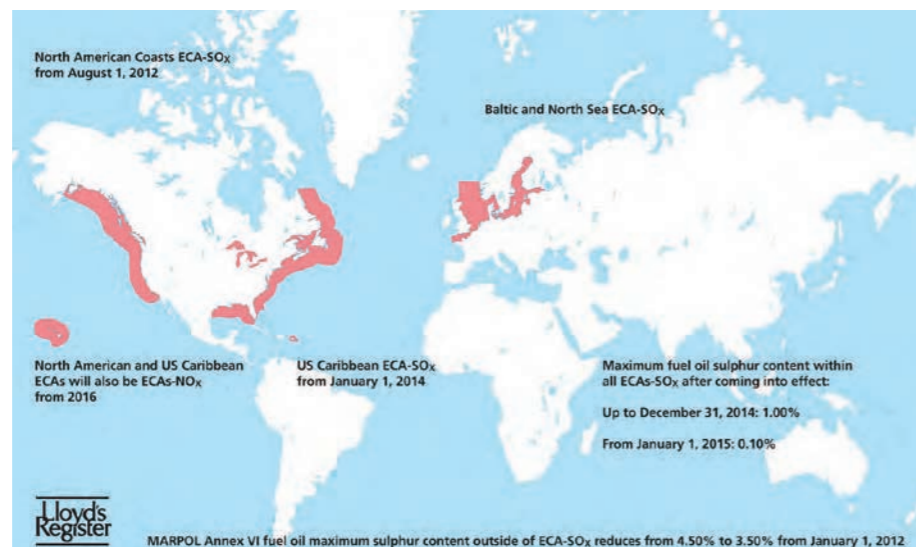

Figure 1.9 Current emission control areas [Lloyd's Register]

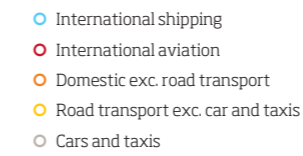
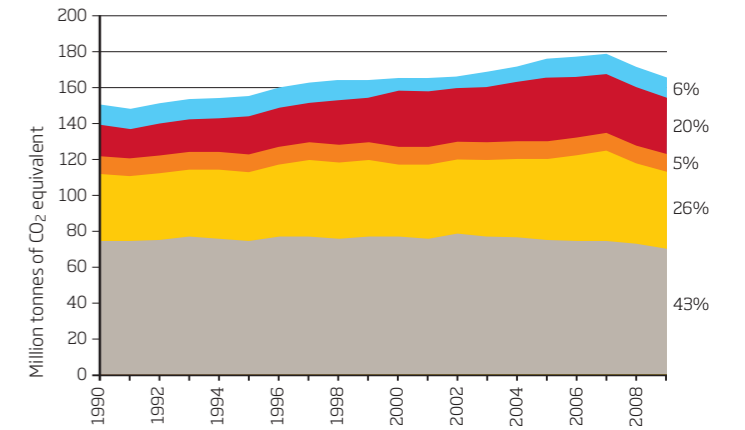

Figure 1.10 Total UK transport greenhouse gas emissions: 1990 -2009 [DfT]



Mode of transport	Relative CO <sub>2</sub> index
Aeroplane	398
Small goods vehicle	226
Large articulated truck	49
Railway haulage	6
Large container ship	3
Large tanker	1

Table 1.4 Relative CO<sub>2</sub> emissions of different modes of transport [MOL, 2004]

## 1.4 Global context of shipping

Ships compare well in CO<sub>2</sub> emission terms with other forms of transport. Using a large tanker as reference for transporting one tonne of cargo over one mile, Table 1.4 shows the relative relationship between different modes of transport. These studies were completed some 10 years ago and in the intervening time technology will have reduced CO<sub>2</sub> emissions in each of the sectors, consequently, today some variation in the absolute detail of the table can be expected. This will be particularly true of the automobile industry where emissions control of engines has been particularly good.

An alternative scenario is based on a statistical analysis of the United Kingdom transport greenhouse gas emissions over the twenty year period 1990 to 2009, (Figure 1.10). It is seen that the international shipping component was around 6% in 2009: the absolute quantity in terms of CO<sub>2</sub> equivalent having remained broadly constant throughout the period under review.

Carbon efficiency has a strong relationship to ship size. Figure 1.11 outlines the approximate trend between the mass of CO<sub>2</sub> emitted per tonne-mile and the size of ships, in this case plotted for container ships and crude oil tankers. Clearly, the trend observable is one of decreasing specific emission with increasing size of the ship.

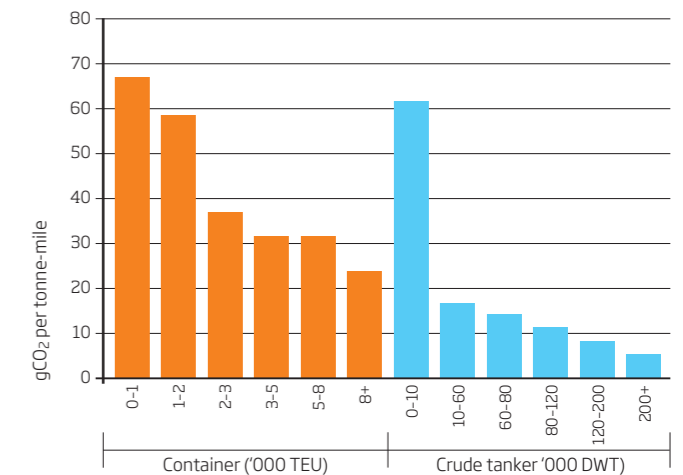

Figure 1.11 Carbon efficiency of container ships and crude oil tankers [Committee on Climate Change (2011)]

## 2. Design options

### 2.1 Ship energy considerations

To achieve full potential efficiency and environmental benefits a ship must be considered as an engineering system within its intended operational profile. This implies that the design, operation and maintenance aspects of the ship have to be considered as an integrated system. More specifically, the integrated design has to embrace, within a single system, the traditional disciplines of naval architecture, marine and electrical engineering together with control technology.

Typical energy flows in a ship are illustrated in Figure 2.1 for a tanker or bulk carrier before any energy saving measures is contemplated.

This ship type has been chosen for Figure 2.1 because they form 64% of the world fleet as seen in Table 1.1. Such a ship could be expected to comprise a slow speed diesel engine directly coupled to a fixed pitch propeller. From the figure it is seen that from the total energy input to the machinery system from the fuel, only around 27% is actually available at the ship's propeller. However, there are a number of options to enhance the overall efficiency and energy available for propulsion purposes; for example, exhaust heat recovery within certain constraints such as the dew point of aggressive chemical species in the exhaust gases, and low grade heat from cooling water systems.

For merchant ships the propeller is usually designed to give high efficiency during operation, consistent with any vibration considerations and operational profile

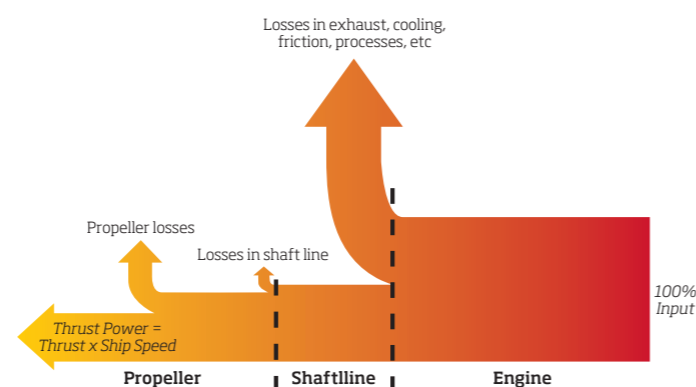

Figure 2.1 Typical power utilisation in a tanker or bulk carrier

### THE PROPELLER OPEN WATER EFFICIENCY IS COMBINED WITH THE HULL EFFICIENCY, RELATIVE ROTATIVE EFFICIENCY AND TRANSMISSION EFFICIENCIES TO GIVE THE OVERALL PROPULSION EFFICIENCY FOR THE SHIP

restrictions. The propeller open water efficiency for large full form ships, such as tankers and bulk carriers, is generally relatively low, albeit that an optimum propeller has been designed for the powering conditions prevailing at the aft end of the ship. In the case of faster and more slender-lined ships, such as container and Ro/Ro ships, the propeller open water efficiency generally rises appreciably. However, the propeller open water efficiency is combined with the hull efficiency, relative rotative efficiency and transmission efficiencies to give the overall propulsion efficiency for the ship.

When poor weather is encountered, further energy losses occur. These arise from the added resistance of the hull due to its interaction with surface waves and underlying swell. Additionally, the wind acting on the ship's exposed surfaces acts as a further source of resistance.

### 2.2 The ship system

If a change to a ship's power generation method is contemplated, either as a departure from conventional practice or in terms of a retrofit, significant implications usually arise for the ship system. From a ship owner's perspective, it may be conceptually convenient to consider a conventional diesel-propelled system being replaced by an alternative propulsion method and then expect the resulting system to operate and behave in the same way as before. However, looking more deeply into the desired solution may show that to swap one prime mover option for another requires the interfaces to the other ship sub-systems to be in the same place or aligned in the same way. This, if achievable, will minimise cost and ease the transition process.

To ascertain the viability of alternative propulsion solutions, the whole market opportunity must be analysed in a systemic and structured manner. In contrast to many current design solutions which have historically evolved, the discipline of systems engineering, (Appendix 5), enables a wider perspective to be taken when radical departures from traditional solutions are contemplated. The design life cycle can be divided into four stages: assembling stakeholder requirements; exploring the system meta-solution to find the best model for success; progressing the design based on the requirements and, finally, defining and analysing the system to ensure it meets the original requirements. Fundamental to this design process is the desired ship's operational profile and the perceived tolerance on this profile necessary to meet market fluctuations. Furthermore, the fluctuations in daily ship and fuel costs that might be anticipated together with the operational profile should be used to define a design space within which the ship system can be progressed.

### TO ASCERTAIN THE VIABILITY OF ALTERNATIVE PROPULSION SOLUTIONS THE WHOLE MARKET OPPORTUNITY MUST BE ANALYSED IN A SYSTEMIC AND STRUCTURED MANNER

## 2.3 Energy Efficiency Design Index

The Energy Efficiency Design Index (EEDI) is a developing ship design parameter which seeks to govern the CO<sub>2</sub> production of ships in relation to their usefulness to society. It is one of three initiatives developed by the IMO MEPC Subcommittee: the others being the Energy Efficiency Operational Index (EEOI) and the Ship Energy Efficiency Management Plan (SEEMP). The EEDI, regarded by some as an imperfect parameter, in its simplest terms is the ratio between the cost to society expressed as the carbon dioxide production potential of the ship and its benefit to society in terms of its cargo capacity and speed for some nominal design point. The CO<sub>2</sub> production potential comprises four components:

- The carbon dioxide directly attributable to the ship's propulsion machinery.
- The carbon dioxide arising from the auxiliary and hotel power loads of the ship.
- The reduction of carbon dioxide due to energy efficiency technologies. For example, heat recovery systems.
- The reduction of carbon dioxide due to the incorporation of innovative energy efficiency technologies in the design. Typically, these might include the introduction of sails or novel hydrodynamic devices.

The EEDI parameter governs the ship design philosophy and the particular value calculated for a proposed ship design has to be verified by an independent organisation against defined criteria, expressed as reference lines, to obtain certification. To define the reference lines parametric studies were undertaken embracing variations in size for the ship types being considered. At present the Index is applied to the design of ships above 400grt and will include tankers, gas carriers, container ships, cargo ships and refrigerated cargo ships. These ships will require an International Energy Efficiency Certificate (IEEC) to show compliance with the EEDI

procedure. However, certain ship types, whatever their size, are for the time being excluded from Index compliance and these are diesel-electric and turbine-driven ships; fishing vessels; offshore and service vessels.

Full implementation of the EEDI-based system is to be achieved within a phased process, not dissimilar to the MEPC Annex VI requirements for NO<sub>x</sub> emissions. To facilitate this, a reducing factor will be applied to the ship type reference lines and the reducing factor will vary with respect to the phase implementation time intervals; currently set at 2013–2017; 2018–2022 and 2023–27. In each of these periods the factor will be set to a prescribed value such that the Required Index value can be reduced in steps.

The Actual EEDI, calculated for the proposed ship design, must then be shown to be less than or equal to the Required EEDI. The computation of the Actual EEDI for a subject ship design is achieved through the use of the relationship defined in Appendix 8. This includes the four CO<sub>2</sub>-producing or regulating components in the numerator while the denominator is essentially the product of ship speed and cargo capacity.

Examination of the Actual EEDI defining equation suggests a number of ways that compliance with the requirements might be achieved as well as options for reducing the value of the Index for a given ship. Typically these are:

- The installation of engines, subject to certain minima, in a ship with less power and, thereby, the adoption of a lower ship speed.
- To incorporate a range of energy-efficient technologies in order to minimise the fuel consumption for a given power absorption.
- The use of renewable or innovative energy reduction technologies so as to minimise the CO<sub>2</sub> production.
- To employ low-carbon fuels and in so doing produce less CO<sub>2</sub> than would otherwise have been the case with conventional fuels.



Picture of carrier taken by crew in storm conditions

### An account of a capesize bulk carrier in a storm (Cooper 2012).

"... in a Storm Force 10/11 with 8 to 10 metre swells,... We managed to maintain about 85% of available main engine power for the 24 hours that we were hove-to. It was just about enough to keep us from falling too far off the wind and seas. We lost about 80 miles that day, with us making two or three knots astern.

"This saga could have a different ending if we had been trapped on a lee shore or in confined waters..."

"...there is no way I could have turned that vessel through the wind with its high accommodation and large square funnel. The main engine governor was giving us the maximum power available for the conditions and although the Chief Engineer could have overridden the governor and increased power, the danger would have been burying the bows repeatedly into the very heavy swell with a high risk of damage to air pipes, stores and rope hatches, and even to the forward hatch covers, not to mention overloading the main engine with a resultant loss of power."

## THERE IS A CONSIDERABLE RANGE OF ENERGY-SAVING TECHNOLOGIES AVAILABLE FOR SHIPS. THESE BROADLY RELATE TO PRIMARY PROPULSION AND HYDRODYNAMIC OPTIONS

- To increase the ship's deadweight by changes to or enhancements in the design.

If the option to install engines into the ship of a lower power rating were adopted, this would be a relatively simple and effective way to reduce the value of EEDI. Such an option, however, begs the question as to whether the ship would then have sufficient power to navigate safely in poor weather conditions. The description in the above text box illustrates a situation where a capesize bulk carrier was caught in a storm (Cooper 2012). Another potentially dangerous situation is to be found in manoeuvring satisfactorily in restricted channels or harbours under a range of adverse tidal and weather conditions. However, in the latter context, tugs might normally be employed.

There is a considerable range of energy-saving technologies available for ships. These broadly relate to primary propulsion and hydrodynamic options. However, there is also an emerging class of devices which are dependent on aerodynamic principles. The deployment of these technologies in specific instances is dependent on the ship's type, size and operational profile, with in some cases sociopolitical considerations, as well as on the ship's hull form. This is further complicated for some existing ship designs in relation to any other energy-saving devices that have been previously fitted: some being incompatible with each other. In all cases, however, a total systems engineering approach should be undertaken to avoid disappointing results.

# 3. Primary propulsion options

SINCE THE 1960s AND 70s THE DEVELOPMENT OF SLOW AND MEDIUM SPEED DIESEL ENGINES HAS BEEN DRIVEN BY THE NEED FOR BETTER FUEL ECONOMY

In the context of this report, primary propulsion options relate to the sources and modes of developing power to propel the ship. In contrast, further propulsion considerations, Section 4 considers the means of converting that power into useful and efficient ship propulsion.



a. Low speed marine diesel engine, the Wärtsilä RT-flex82T version B main engine © Wärtsilä



b. Medium speed diesel engine © Wärtsilä

Figure 3.1 Typical marine propulsion diesel engines

## CONVENTIONAL PROPULSION OPTIONS AND FUELS

### 3.1 Diesel engines

Today diesel propelled machinery is the principal means of marine propulsion. Engines are broadly classified into slow speed two stroke; medium speed four stroke; and high speed four stroke engines; (Figures 3.1 (a & b)). While some ships, due to their design and operational profile, use either slow or medium speed diesel engines as the principal mode of propulsion, most ships are fitted with additional medium or high speed diesel engines to drive generator sets for auxiliary power purposes. Additionally, all merchant ships have an emergency means of generating electrical power as required by SOLAS.

Since the 1960s and 70s the development of slow and medium speed diesel engines has been driven by the need for better fuel economy. The result has been increased stroke/bore ratio, peak pressures and mean piston speeds in slow speed, two stroke engines to achieve significant reductions in specific fuel oil consumption.

Similar improvements in turbocharging efficiency, fuel injection technology, brake mean effective pressure and firing pressures have brought down specific

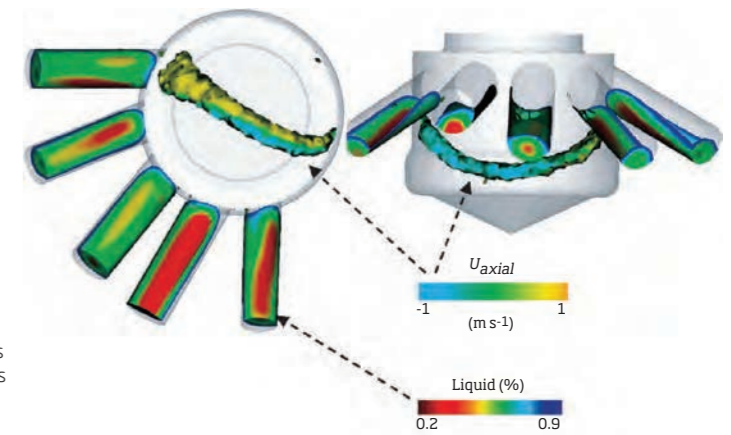

Figure 3.2 Flow studies in diesel injector nozzles [edited from Andriotis et al. 2008]

fuel oil consumption in medium speed four stroke engines. Typical of these developments have been flow studies in injector nozzles with particular reference to the effects of cavitation on fuel atomisation and spray structure and repeatability; (Figure 3.2).

However, since the early 1990s, the drivers for diesel engine development changed. The concept of reduction of NO<sub>x</sub> and SO<sub>x</sub>, involving primary and secondary processes, without detriment to fuel consumption became a major priority to meet the limits imposed in current and future emission control areas. The result has been a number of developments in marine diesel engine technology which include:

#### Primary methods

- Low NO<sub>x</sub> combustion, adjustable camshafts
- Variable inlet valve control
- Improved combustion chamber design
- Higher boost pressures
- Greater mechanical strength in engine architecture
- Development of two stage turbocharging
- Exhaust gas recirculation
- Waste gate technology
- Sequential turbocharging
- Variable turbine geometry

- Humidification of inlet air or water injection
- Emulsification of fuels

#### Secondary methods

- Selective catalytic reduction systems
- Low sulphur fuels for SO<sub>x</sub> limitation
- Exhaust gas scrubber systems both using direct seawater scrubbing or closed circuit freshwater scrubbing

The primary methods of limiting NO<sub>x</sub> production in the combustion process are directed towards optimising the engine parameters which include reducing the peak temperature and duration of the process, by much higher-pressure fuel injection over a shorter period, accurate timing and control of the injection, the use of Miller inlet valve timing and higher-pressure turbocharging. This has led to current developments in two-stage turbocharging for even higher operating pressures but with significantly lower fuel consumptions, thereby making way for further efficiency improvements in engines.

Debate among engine builders exists concerning the most effective method for the various engines. Exhaust gas recirculation is a method which can be deployed for NO<sub>x</sub> reduction purposes in

#### MILLER CYCLE

In the Miller Cycle the charge air is compressed to a higher pressure than is needed for the engine cycle. A reduced filling of the cylinders is then controlled by suitable timing of the inlet valve which then permits some expansion of the charge air to take place within the cylinders. This expansion process allows cooling of the charge at the beginning of the cycle whereupon its density increases. This results in the potential for the power of a given engine to be increased. The practical application of the Miller Cycle, however, requires a turbocharger capable of achieving high compressor pressure ratios in association with high efficiency at these conditions. While initially developed with the aim of increasing engine power density, it has been found that the Miller Cycle can be used, by reducing cycle temperatures at constant pressure, to reduce NO<sub>x</sub> formation during combustion.

slow and medium speed diesel engines. In the case of two stroke, slow speed engines, development programmes have been undertaken with exhaust gas recirculation systems over the last 20 years or so. Among these have been in-service trials conducted onboard the *Alexander Maersk* which have made useful contributions to the understanding of these systems. With the EGR method of NO<sub>x</sub> reduction some of the oxygen in the scavenged air is replaced with CO<sub>2</sub> since carbon dioxide has a higher heat capacity which reduces the peak temperatures within the cylinders. In-service trials have shown that components in the system such as the piston rings, EGR blowers, the water mist catcher and control systems have performed well. Water injection into the cylinders at the time of combustion and humidification of the inlet air is also helpful in reducing the NO<sub>x</sub> content of the exhaust gases from slow speed engines. Several methods have been designed and tested for this purpose by the various manufacturers of slow and medium speed engines.

An additional secondary method of NO<sub>x</sub> reduction to meet the Tier 3 targets is selective catalytic reduction. SCR systems can be useful when working in emission control areas; however, cost becomes a critical factor when deciding on the most appropriate system. In the case of medium speed, four stroke engines it is reported that SCR systems offer an 80% improvement in NO<sub>x</sub> reduction (Troberg, 2012). One approach relies on the injection of ammonia into the exhaust gas flow, usually in the form of a urea solution. This reacts with the NO<sub>x</sub> exhaust component at the surface of the selective catalytic reduction elements to form N and H<sub>2</sub>O. This method, however, requires space to be allocated in the ship for the urea storage, the dosing and

control systems, and the selective catalytic reduction elements which may replace the normal silencer.

The Green Ship of the Future Project undertook a retrofit study for a 38,500 dwt tanker powered by a slow speed diesel engine which was planned to spend 13.5% of its time in an environmental control area (Green Ship of the Future Project, 2012). Three options were considered: the use of low sulphur fuel; placing an exhaust gas scrubber in the system or using LNG as a fuel. The low sulphur fuel option introduced some lubrication issues. The exhaust scrubber alternative, based on using heavy fuel oil after 2015, required a new funnel layout due to the introduction of the scrubber together with its associated machinery and new tanks. In the latter case, the LNG fuel usage required new piping and a fuel supply system together with new LNG tanks; in this case two 350 m<sup>3</sup> tanks mounted on deck. The associated costs, based on industry quotations, for these last two options were estimated at 5.84M US\$, 50% of which was for the scrubber and auxiliary machinery, and 7.56M US\$ respectively. In the LNG case, the tanks and machinery conversion were costed at 4.38M US\$ with 40 days' off-hire time. In contrast the scrubber option required an estimated 20 days' off-hire time.

A new class of ultra-long stroke engines has been introduced into the marine propulsion market. These engines have a lower design speed and if used with an optimum large diameter propeller at these low rotational speeds, the overall ship propulsion efficiency can be enhanced. This hydrodynamic benefit can then be coupled with the enhanced fuel oil consumption characteristics of the engine. Table 3.1 shows the quoted fuel consumption

## A NEW CLASS OF ULTRA-LONG STROKE ENGINES HAS BEEN INTRODUCED INTO THE MARINE PROPULSION MARKET. THESE ENGINES HAVE A LOWER DESIGN SPEED AND IF USED WITH AN OPTIMUM LARGE DIAMETER PROPELLER AT THESE LOW ROTATIONAL SPEEDS, THE OVERALL SHIP PROPULSION EFFICIENCY CAN BE ENHANCED

differences between an ultra-long stroke engine and a more traditional engine.

To reduce fuel consumption there has been a tendency to run large marine engines at part load. While such restrictions have largely been confined to continuous powers above 60% of maximum continuous rating (MCR), more recently in container ship operation these limitations have been as low as 10% MCR. To achieve these very low loads the lubricating oil supply has to be reduced together with the introduction of engine tuning methods for part and low load. Of significance in this context are exhaust gas bypass; variable turbine area; engine control timing and high-pressure tuning.

In the marine industry, while fuels are classified into different grades there are no standard specifications. Consequently, fuel composition and quality can be variable when bunkering in ports around the world. While slow speed engines are reasonably tolerant of fuel variations, medium speed engines tend to be less so (Wilson, 2012). However, that the fuels lack specification does not imply that the diesel engine combustion processes cannot be managed. Indeed, guidelines for fuel ignition and quality to assist in the fuel management processes have been developed (CIMAC 2011). Since the marine supply chain has been contaminated to a small extent with biofuels, (Section 3.2), in the case of distillate fuels, additional management practices need to be put in place to control this aspect.

To control the sulphur in the fuel the ship operator has three principal choices. The first is to bunker low sulphur fuels either wholly or partially, so that in the latter case the ship can switch to a low sulphur fuel when in an ECA. This, however, has implications for fuel storage and handling systems on the ship; changeover processes; the technology of engine and boiler fuel injection systems and the choices of lubricating oils, etc. An alternative solution

is to install secondary abatement systems for the removal of sulphur from the exhaust after combustion. This requires the use of high volumes of seawater or, alternatively, a smaller volume of freshwater with a dosing of caustic soda. There is also a further process which is based on the ionisation of seawater. The third choice is the use of LNG as a fuel, which is principally methane (CH<sub>4</sub>); see Section 3.3. However, methane is a greenhouse gas and if significant methane slip occurs within the engine combustion or bunkering processes this aspect can be enhanced.

### METHANE SLIP

Methane slip is a cause for concern because of the properties of methane, when considered as a greenhouse gas, are 21 times more potent than CO<sub>2</sub> (IPCC 1995). It may derive from two sources, the first being operational emissions while the second derives from engine emissions. In the first case, this may be from the venting of methane to atmosphere during refuelling while in the latter case of engine emissions this relates to unburnt or incomplete combustion of methane passing through the engine system. In the context of engine emissions, methane slip may be due to the engine concept, engine design, its operational profile or due to maintenance.

### Some potential advantages and disadvantages of the technology:

#### Advantages

- i. Diesel engine technology is a well-understood and reliable form of marine propulsion and auxiliary power generation technology.
- ii. The training of engineers to operate diesel machinery is well known and facilities exist for the appropriate levels of education.
- iii. Engine manufacturers have well-established repair and spare part

Engine parameter	K98 ME engine	S90 ME engine
Stroke (mm)	2660	3260
Speed (rpm)	97	84
Specific fuel oil consumption (g/kWh)	174	167

Table 3.1 Comparison between an ultra-long stroke and a traditional engine (Jakobsen 2012)

- networks around the world.
- iv. Diesel fuel in all grades has a worldwide distribution network and is easily obtainable.
  - v. Many primary and secondary methods for reducing emissions which are perceived to be harmful are now available. Furthermore, there is a continuing programme of research and development being undertaken by the engine builders.
  - vi. Diesel engines are generally able to cope with part load, transient and dynamic behaviour in a seaway.

#### Disadvantages

- i. Diesel engines produce CO<sub>2</sub> emissions as well as NO<sub>x</sub>, SO<sub>x</sub>, volatile organic compounds and particulate matter. Therefore, they have to be made compliant with the MARPOL Annex VI requirements and included during an EEDI evaluation of the ship.
- ii. The SO<sub>x</sub> emissions are a function of the sulphur content of the fuel used in the engine and to comply with regulations an abatement technology has to be employed.
- iii. There is now some contamination of the marine fuel supply by first-generation biofuels which needs to be carefully managed on board ships.

## 3.2 Biofuels

Living systems comprise a collection of cells, genes and proteins which permit them to grow and replicate. Understanding these complex systems has occupied biologists and chemists for much of the last century and has resulted in first generation biofuels with work continuing on subsequent generations. The first-generation of biofuels in widespread use are biodiesel and bioethanol. Biodiesel is produced from animal fats and vegetable oils such as coconut, palm, rape seed, soybean and tallow. These fuels are generally known as Fatty Acid Methyl Esters (FAME) and are produced by reacting the vegetable oil or animal fat constituents with an alcohol such as methanol. In contrast, bioethanol is produced by fermenting renewable sources of sugar or starch, typically cassava, corn, sorghum, sugar beet, sugar cane, and wheat.

There are a number of chemical compositions of FAME raw materials. The blend levels used result in fuels having some variability in their cold temperature performance, degradability and stability. In turn, this has implications for handling, storage, treatment, engine operations and emissions.

FAME is able to hold high levels of water in suspension and water may also induce hydrolytic reactions which break down the FAME to form fatty acids. These are corrosive and can attack metal surfaces. Alternatively, if the water separates out of the FAME fuel this may give rise to microbiological growth which can then lead to the filter clogging. Corrosion problems have also been experienced when used with marine diesel engines.

A recent trial centred on the container ship *Maersk Kalmar* (Lloyd's Register 2011) endeavoured to evaluate the impact of Fatty Acid Methyl Esters and marine distillate fuel containing FAME. The focus of this trial was undertaken in the contexts

## USING BIOFUELS DERIVED FROM NATURAL SOURCES SUCH AS VEGETABLE OILS WOULD REQUIRE A LAND AREA EQUIVALENT TO THAT OF ABOUT TWICE THE SIZE THE UNITED KINGDOM

of storage, fuel handling, health, safety and the environment. Additionally, the influence on exhaust emissions, lubricating oil performance, material compatibility and long-term storage were also considered. In part, these trials were stimulated by the current practice within the automotive industry of blending FAME into diesel fuels intended for the automotive sector which, therefore, enhances the probability of cross-contamination with the marine distillates. This probability is further influenced by the EU marine fuel sulphur requirements at berth of 0.1% and inland waterways of 0.001%. The *Maersk Kalmar* trials showed that while the automotive biodiesel formulation was not optimal for ship propulsion, the fuel was usable during the trials. Furthermore, concerns over microbial growth were shown not to be an issue within the confines of the trial; however, further investigation of this aspect was considered necessary in the future. Similarly, as engine running and lubricant interaction times were relatively short within these trials, to arrive at definitive conclusions further sea trials and test bed running were recommended.

The processes involved in biofuel production from sugar or vegetable oils are not particularly efficient and waste a significant quantity of the biomass or organic matter. The underlying reason for this is that stalks and leaves, although rich sources of sugars, are discarded because they are difficult to break down with present technology. Consequently, an efficiency enhancement for these processes must await the development of the necessary enzymes.

In contrast to FAME the bioethanols are single chemical compounds which are colourless, hygroscopic, miscible with water and are volatile. However, since bioethanol is hygroscopic and highly soluble in water, small quantities of water can be dissolved in fuel blends containing bioethanol and separation of the ethanol can result when critical levels of water take-up are reached. This facilitates alcohol-rich water/ethanol

aqueous and alcohol-weak gasoline phases to form which then create the potential for combustion problems. Moreover, the former phase will collect at the bottom of the storage tanks in the ship and is likely to be very corrosive. Furthermore, while bioethanol behaves as a solvent which effectively cleans dirty storage tanks and fuel lines it becomes contaminated during this process.

To power the current worldwide fleet of merchant ships, it is estimated that it would require around  $7.3 \times 10^{18}$  J/year (MacKay, 2011). Using biofuels derived from natural sources such as vegetable oils would require a land area equivalent to that of about twice the size the United Kingdom (MacKay 2011). Oilseed rape, when used to produce biodiesel, has a power per unit area potential of about 0.13W/m<sup>2</sup> (MacKay, 2009). Notwithstanding the size of the land required for this purpose, there is also the ethical question of whether it might be better to deploy such agricultural areas for world food production.

The science of synthetic biology, in the context of fuels, has focused on the production of biodiesel and bioethanol. In the longer term more advanced biodiesel fuels are likely to be developed together with the associated synthetic biology-based processes for efficient fuel production in significant quantities (Royal Academy of Engineering 2009). Alternative synthetic fuels based on the branch-chain higher alcohols and new types of E-coli as well as other types of microorganisms, such as yeast, may make their appearance. In the case of algae-derived fuels, these are generally no more efficient at photosynthesis than land-based plants; however, this efficiency can be enhanced by water heavily enriched with CO<sub>2</sub>. Even with this efficiency improvement, algae-derived fuels are unlikely to satisfy the demands of the worldwide marine industry.

A further alternative fuel for compression-ignition engines is di-methyl ether (DME). This can be produced from the conversion

## TO DEVELOP THE SAME LEVEL OF ENERGY AS CONVENTIONAL DIESEL FUELS, DI-METHYL ETHER REQUIRES A HIGHER INJECTED VOLUME OF FUEL DUE TO ITS LOWER DENSITY AND COMBUSTION ENTHALPY

of a number of sources including natural gas, coal, oil residues and biomass. DME is relatively easy to handle; indeed it is not dissimilar to LPG, because it is condensed when pressurised above 0.5MPa and it is thought to be both non-toxic and environmentally benign. DME has a high cetane number which may lead to a better mixing with air in the engine cylinder (Arcoumanis et al 2008) while its high oxygen content can achieve smokeless combustion through the low formation and oxidation rates of particulates. Notwithstanding these potential benefits, to develop the same level of energy as conventional diesel fuels, di-methyl ether requires a higher injected volume of fuel due to its lower density and combustion enthalpy. Moreover, DME-fuelled systems require lubricity-enhancing additives and anti-corrosive sealing materials to maintain leakage-free operation. Additionally, if DME were used as a fuel some attention would have to be paid to the optimisation of the fuel injection equipment to allow for the low density, low lubricity and corrosiveness of the fuel.

Research has suggested that di-methyl ether when used in compression-ignition engines, despite its disadvantages, is able to provide high thermal efficiency with low combustion noise and NO<sub>x</sub> levels together with soot-free combustion. Consequently, this alternative fuel merits further study. However, to deploy it in the marine industry on a worldwide basis would require a fuel supply chain network to be developed which could sustain the needs of the industry. This latter issue would be lessened if it were used for short sea and inter-island type services.

### Some potential advantages and disadvantages of the technology:

#### Advantages

- Biofuels are potential alternatives to conventional fuels.
- Synthetic fuels based on branch-chain higher alcohols and new types of algae and other microorganisms are a medium- to long-term possibility, given that production volumes can satisfy

the demand from the marine and other markets.

- Di-methyl ether shows some potential benefits as an alternative fuel.
- Synthetic fuels can be derived from syngas, created by partial combustion of a wide range of biomass feedstocks.

#### Disadvantages

- With the first generation of biofuels, biodiesel and bioethanol, problems have been experienced when used in the marine environment. However, this may not be the case with the second-generation biofuels.
- At the present time, significant land areas need to be devoted to first-generation fuel production to satisfy the marine market.
- The effective greenhouse gas emissions of all types of biofuels, including fuels derived from biomass, is currently an area of active research. It is possible that the available global resource of biomass and biofuels may be inadequate to supply shipping.
- The production processes used at present to convert sugars and vegetable oils are not particularly efficient, but research is underway to enhance this aspect.
- Further work is necessary to examine aspects of storage and handling of these fuels, and their impact on health, safety and the environment.
- The presently perceived disadvantages of di-methyl ether in terms of its lubricity and corrosive issues together with creating sufficient production and supply require resolution.

## 3.3 Liquid natural gas (LNG)

The burning of natural gas in internal combustion engines is not a new concept. Neither is its use associated with diesel-electric propulsion or mechanical drive systems for ships. A significant step in the adoption of natural gas as a fuel has been the Dual Fuel Diesel-Electric systems on LNG carriers that are either being built or already in service. However, ship operating philosophies have varied between companies. Some operators prefer to use conventional heavy fuel oil when its cost is lower than the commercial value of boil-off gas from the LNG tanks; or when the ship is running with limited LNG on board in the ballast condition or during lay-up. In this case the need for a shipboard re-liquefaction is limited. However, it can be installed so that on the occasions when the boil-off cargo exceeds the ship's fuel requirements the additional boil-off fluid can be returned to the cargo tanks. By way of contrast, a large fleet of ships has been built using the opposite philosophical viewpoint. These ships operate on heavy fuel oil and use a large liquefaction plant to reliquefy all of the boil-off LNG; this auxiliary plant also runs on heavy fuel oil. Consequently, these latter ships deliver all the cargo loaded and use heavy fuel oil for the ships' operational energy needs.

Given the recent volatility of world oil prices the price of LNG in terms of net energy value has been consistently lower by a significant margin. Furthermore, the availability of LNG is growing at a fast rate from both conventional and shale gas reserves. Consequently, the attractiveness of LNG as a marine fuel, subject to the logistical hurdles being overcome, has been growing in strength.

The principal constituent of LNG is CH<sub>4</sub> which, when used as a fuel, reduces CO<sub>2</sub> emissions by around 25%. Additionally, the lesser amount of nitrogen in the combustion

process, due to the compression ratios and combustion temperatures for CH<sub>4</sub>, reduces NO<sub>x</sub> production by around 85%. This meets the MARPOL Annex VI, Tier 3 limits without the need for selective catalytic reduction. Furthermore, since sulphur is absent from the fuel, no SO<sub>x</sub> emissions are produced. In the context of the EEDI the use of LNG as a fuel with its associated CO<sub>2</sub> savings would reduce the Actual EEDI for a ship by 25%.

When liquefied, the storage space required for natural gas is about four times higher than for conventional fuels. There is also a need for well-insulated tanks and a safe area in case of accidental spillage. Consequently, the required storage space on a vessel will be greater than that needed for conventional fuel oils which may impact on the available cargo volume for the ship. Clearly, however, there are many alternative tank arrangements that might be adopted as well as a number of system alternatives by which LNG can be utilised for propulsion purposes. One option comprises a slow speed, gas injection engine with LNG delivered under pressure to the engine. The fuel is then vaporised at the engine, thereby making the process safer, easier to install and operate rather than delivering high-pressure natural gas from the fuel tanks. With this arrangement, high gas injection pressures are needed so as to overcome the cylinder pressure in the upper part of the piston stroke as well as being able to get the required mass of gas into the cylinder within a short time interval. An alternative arrangement is a low-pressure two stroke dual-fuel engine. This has the low pressure LNG gas admitted by valves around the cylinder at the bottom of the stroke which is then ignited by pilot fuel at the end of compression. A further option is the established DFDE system used on LNG carriers which has now also been deployed on a passenger ferry. In another context, if a cruise ship used LNG as a propulsion fuel, evaporating the fuel could be used to provide cooling in the air conditioning system.



## THERE ARE MANY LAND-BASED FUEL OIL BURNING POWER PLANTS THAT HAVE BEEN CONVERTED TO RUN ON GAS... SIMILAR CONVERSIONS ARE FEASIBLE ON SHIPS

In cases where a ship is lying at anchor or delayed in port and a reliquification plant is not fitted, then methane may have to be vented or burnt off to maintain tank pressures at acceptable levels. This would result in reduced operational efficiency and add to the global warming burden.

The coldness of LNG can be used to cool the inlet air of a prime mover to 5°C. For a gas turbine this is particularly effective and enables the turbine to be run at 110% of its rated efficiency, even when ambient temperatures would otherwise produce an inlet temperature of 38°C. Such an inlet temperature would imply running at 73% efficiency which is a gain of 50% overall. (TICA 2012)

Dual-fuel engine experience of well over a million hours shows that times between overhauls are extended and component lifetime is longer; the combustion space in the engines has remained much cleaner and products of combustion in turbochargers and lubricating oils are much less of a problem.

Offshore supply vessels and ferries have now been built to operate on LNG where the availability of the fuel exists: Figure 3.4 shows the example of the *MF Fanaffjord* which operates a short sea crossing in a Norwegian Fjord and uses spark ignition gas engines.



Figure 3.4 *MF Fanaffjord*: an LNG fuelled ferry [Courtesy A. Greig]

There are many land-based fuel oil burning power plants that have been converted to run on gas due to restrictions on emissions having been imposed in the country of operation and/or where the price and availability of gas is more favourable. Similar conversions are feasible on ships. A recent example is the chemical carrier *mv Bit Viking* which had its twin diesel engines converted for operation in the Baltic and Norwegian waters on LNG. The conversion process included the cylinder heads and liners, pistons and rings, the connecting rods and turbochargers. In addition, gas rails and admission valves together with a pilot fuel system were required. For this, in the case of the *Bit Viking*, two 500m<sup>3</sup> storage tanks were mounted on the open deck giving the ship 12 days of operation at 80% load between bunkers. More recently, in December 2012, an order was placed for a pair of liquefied natural gas-powered Jones Act 3,100 teu containerships. These ships are dual-fuel vessels and are planned for delivery in 2015 and 2016. The ships, which are reportedly more expensive to build, are planned to operate along the west coast of the United States of America, which falls within an ECA, as well as during one third of a Florida-Puerto Rico voyage which is also in the ECA. For these ships it is planned to use LNG as the primary fuel at all times, with diesel serving as backup.

Unlike the current diesel bunkering infrastructure for the majority of seagoing ships, there is presently a lack of a similar system for the supply of LNG to support the operation of LNG-fuelled ships. However, a number of major commercial ports on the world trade routes have LNG terminals in the vicinity which serve land-based consumers and these facilities might be adapted to additionally serve the marine community. This would require additional financial investment as well as the provision of a bunker fleet or safe bunkering jetties. Indeed, some ports already have plans for such investment, typical of which is Singapore, but rather more supply ports would be required before LNG-fuelled deep sea ships could be considered totally viable. In Europe a second jetty is being built in the port of Zeebrugge to accommodate ships between 1,500m<sup>3</sup> and Q-Flex sizes and Antwerp already bunkers LNG-fuelled inland waterway barges. As such, the LNG bunkering distribution network will embrace Scandinavia, Belgium and The Netherlands with further plans developing. In the case of short sea ferry or inter-island type routes, then either bespoke local terminals or supply by road tanker may provide a solution.

Since classification society rules already exist for the burning of LNG fuel in ships and coupled with the design and operational experience having been satisfactory to date, there is little of a technical nature that would prevent the adoption of LNG as a marine fuel. Any constraints would largely derive from commercial considerations and relate in significant measure to the likely future price differentials between LNG and conventional fuels as well as availability at ports.

### Some potential advantages and disadvantages of the technology: Advantages

- LNG fuelling of reciprocating engines as a known technology and service experience, albeit limited at the present time, has been satisfactory.

- The benefits in terms of CO<sub>2</sub>, NO<sub>x</sub>, SO<sub>x</sub> and the other emissions are significant.
- Designs for suitable marine propulsion machinery systems exist.
- It is relatively easy to convert many existing marine engines to burn LNG.
- Currently LNG fuel is considerably cheaper than the conventional range of marine fuels.

### Disadvantages

- Methane slip has to be avoided during the bunkering and combustion processes of new and in-service engines since this is damaging in the context of greenhouse gases.
- There is a general lack of a worldwide bunkering infrastructure at present.
- LNG requires a heat source to evaporate it to form the gas. As well as using the inlet air to the prime mover, it may be possible to use a heat exchanger with sea water, but some fuel is likely to be needed to be burned to provide this low-grade heat.

## 3.4 Gas turbines

Gas turbines were first introduced into warship propulsion in the 1950s to facilitate high speed sprint modes of operation since their power density was high. A further operational advantage was the relative ease with which gas turbines could be started and stopped which gave rapid access to high levels of power. Gas turbines can be used either in purely mechanical propulsion drive configurations or alternatively to generate electricity, which is then used by electric drives to propel the ship. This gave rise to a variety of hybrid powering arrangements involving combinations of gas turbines with steam turbines (COSAG); with diesel engines (CODAG) and with diesel generators (CODLAG) to accommodate the evolving power requirements of a modern warship: typically loiter, towed array deployment, cruise and sprint modes.

## IN THE 1950s SHELL EXPERIMENTED WITH A GAS TURBINE IN THE TANKER, AURIS, WHILE THE LIBERTY SHIP JOHN SERGEANT WAS RETROFITTED WITH AN INDUSTRIAL GAS TURBINE

Introduction of the gas turbine into the merchant service was more gradual by comparison with naval applications. Apart from early full-scale hull resistance research exercises using the Clyde paddle steamer *Lucy Ashton* at the end of its commercial service life, there were a number of early applications of gas turbines. In the 1950s Shell experimented with a gas turbine in the tanker, *Auris*, while the liberty ship *John Sergeant* was retrofitted with an industrial gas turbine. Then around 1968 the RoRo ship *Adm W.M Callaghan* was built having two aero-derived Pratt & Whitney FT4 gas turbines and leased to the USN Sea Lift command. In 1971 the containership *Euroliner* also featured two Pratt & Whitney FT4 gas turbines and sailed between the US and Europe. The twin screw high-speed ferry *Finnjet* in Baltic Sea followed during 1977 and then more recently with cruise ships including the *Millennium Class* and *Queen Mary 2* in the early 2000s. As with naval ships, these latter vessels were designed as combined cycle ships with combinations of gas turbines and diesel-electric generators.

For the merchant ship gas turbine market two types of prime mover made their appearance: the aero-derivative and the industrial gas turbines. The former were able to supply high power but requiring the use of high grades of fuel, while the latter generally gave more modest levels of power but used poorer grades of fuel as well as offering easier maintenance regimes. Typical of the latter application were the *HS1500* high-speed catamaran car ferries which operated for a time on a number of routes around the United Kingdom and elsewhere.

A range of commercially available aero-derivative gas turbines have been designed for the marine market; these include the LM2500, the WR21 and the MT30, Figure 3.5. Earlier machines included the Olympus and Tyne gas turbines. In the case of the MT30 this has a maximum rating of 40MW at 15 °C and a thermal efficiency

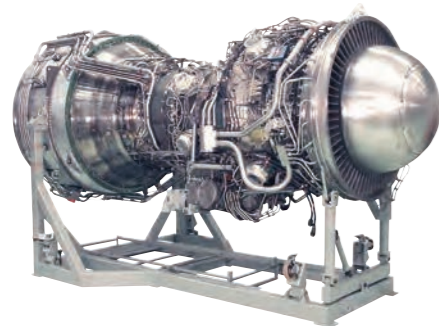

Figure 3.5 mt30 marine gas turbine. This photograph is reproduced with the permission of Rolls-Royce plc, © Rolls-Royce plc 2013

of just over 40%. Consequently this fits the power requirements of a number of merchant ship types and sizes. The WR21 was a further development in marine gas turbine technology with variable inlet turbine stator vanes and incorporating both compressor inter-cooling and exhaust heat recuperation technologies. This thermodynamic arrangement was designed to deliver low specific fuel consumption together with a thermal efficiency in the region of 43%. This engine is used as a source of power for the Type 45 destroyers of the Royal Navy. Additionally, the WR21 has an enhanced part-load performance.

Gas turbines have the advantage of low weight when compared to their diesel engine equivalents: typically the MT30 unit weighs about 28 tonnes including the enclosure and ancillary components. This weight advantage, therefore, allows designers considerable flexibility in locating gas turbines in a ship when a turbo-electric drive is specified.

The advanced modern aero-derivative gas turbine units are designed to burn commercially available distillate fuels which meet the current legislation on emissions and smoke requirements. Distillate fuels, however, are considerably more expensive than the conventional marine fuels burnt in diesel engines used by merchant ships: for example, the ratio of distillate fuel price to an average of 180 cSt and 380 cSt bunker fuel was 1.5 in October 2012 (Bunkerworld 2012). For this reason they are not currently favoured in the merchant marine industry.

A further variation of gas turbine technology is the combination of a gas turbine with a heat recovery steam turbine running on the flue gases, enabling a rather greater overall thermal efficiency for electricity generation.



Figure 3.6 ns Savannah [Courtesy] S. Carlton

### Some potential advantages and disadvantages of the technology: Advantages

- Gas turbines represent a proven high power density propulsion technology.
- Their low weight gives considerable flexibility when locating them in a ship.
- NO<sub>x</sub> emissions are low and SO<sub>x</sub> emissions negligible because higher grades of fuel are burnt.
- Maintenance is normally running hours-based and the turbines can be removed from the ship for replacement relatively easily.

### Disadvantages

- The fuel for aero-derivative gas turbines is currently expensive when compared to conventional marine fuels because it is a high distillate fuel.
- All gas turbines are less efficient as the ambient temperature rises, and this is particularly true of aero-derivative turbines (TICA 2012).
- Thermal efficiencies are lower than for diesel engines of similar power.

## OTHER PROPULSION TECHNOLOGY OPTIONS

### 3.5 Nuclear

Existing onboard energy storage and power generation systems predominantly develop power by breaking chemical bonds between atoms. In contrast, nuclear power generation is the fission of large, heavy nuclei into smaller fission products under controlled chain reactions; (Appendix 6). This releases a large amount of heat energy which is transferred to a coolant to generate useable power via an appropriate thermodynamic cycle. Nuclear propulsion, therefore, represents a potentially radical solution by being a CO<sub>2</sub>-free propulsion source when operating.

Nuclear ship propulsion is not new, it was first introduced into the submarine environment, together with stringent crew selection, education and training regimes, by Admiral Rickover of the United States Navy in 1955 when the *USN Nautilus* sailed on its maiden voyage. Since that time, some 700 nuclear reactors have served at sea and today there are around 200 reactors providing the power to propel ships and submarines. Shortly after the naval initiatives the *NS Savannah* (Figure 3.6) was conceived as a passenger cargo demonstrator ship under

## MOLTEN SALT REACTORS ARE POSSIBLE FUTURE CANDIDATES FOR SHIP PROPULSION, HOWEVER, A LENGTHY PERIOD OF RESEARCH AND DEVELOPMENT IS NECESSARY FOR THIS TO HAPPEN.

President Eisenhower's Atoms for Peace programme. Following the *NS Savannah* in the 1960s, the *Otto Hahn* and *Mutsu* came from Germany and Japan respectively; again both ships being largely designed as demonstrators for nuclear propulsion. Since that time, a relatively small number of other nuclear-propelled merchant ships have been built, most notably the Russian icebreaker classes with perhaps the most famous being the *Lenin*, as well as a number of dual purpose ships engaged on specialist duties, such as the *Yamal* and, more recently, the *50 Years of Victory* which are combined passenger cruise ships and icebreakers.

There are several potential fuels, modes of fission and reactor coolants that could be used for merchant ship propulsion. However, the most common reactor type is the uranium-fuelled pressurised water reactor. Natural uranium comprises three isotopes: <sup>238</sup>U, 99.3%; <sup>235</sup>U, 0.7% and <sup>234</sup>U, 0.005%. The fissile component in the fuel is <sup>235</sup>U where neutrons emitted in the fission process are slowed down (moderated) by the coolant (water) before causing fissions in further <sup>235</sup>U atoms. The energy absorbed by the coolant is transferred to a secondary steam cycle that generates either electricity or direct shaft power. In PWR reactors only a small percentage of naturally occurring uranium is fissionable, <sup>235</sup>U, which implies that uranium has to be enriched in its <sup>235</sup>U component. While it is possible to achieve virtually any level of enrichment that is desired, uranium for use in civilian programmes is generally around 5% of <sup>235</sup>U. Levels of enrichment of 20% or greater are subject to stringent controls due to international safeguards and nuclear weapons proliferation concerns and are only used in specialist or military applications.

Another potential source of fissionable uranium fuel is thorium which is more plentiful than uranium and typically exists in the soil in concentrations of around 6

ppm. Development in various parts of the world is being undertaken to produce a robust reactor for this fuel source which has a further advantage in that the half-lives of the irradiated products are generally considerably shorter than those from natural uranium based fuels. Thorium-based reactors, depending on their configuration, may only produce some 3% of the high level waste developed by current nuclear reactors and have a lower weapons proliferation risk than conventional uranium-plutonium cycle reactors. However some thorium reactors require starter fuels to grow the fissile <sup>233</sup>U. Therefore, they do not displace some level of security being deployed.

### THORIUM REACTORS

A number of options exist for utilising the energy contained in Thorium all of which involve the breeding of Th into <sup>233</sup>U. Typically these are:

- Solid fuel in a light water reactor.
- Liquid metal cooled fast breeder reactor.
- Gas-cooled fast breeder reactor.
- Sub-critical accelerator driven.
- Molten salt reactor.

Each of these options has relative advantages and disadvantages and in some cases they are currently at the theoretical concept stage: China announced in early 2011 that it was starting a molten salt thorium reactor programme. Molten salt reactors embrace a family of reactor designs that use a mixture of molten fluoride, or chloride salts as the coolant with operating temperatures of the order of 650°C. More recently an investigation has been undertaken to assess the potential for molten salt reactors to power warships (Hill et. al. 2012).

Table 3.2 Proposed small modular reactor designs

Small reactor designs	Country of manufacture	Power output (MWe)
KLT 40S	Russia OKBM	35
VBER 150	Russia OKBM	110
SMART	South Korea KAERI	100
MRX	JAERI	30
SMR	United States of America Westinghouse	200
mPower	United States of America B+W	125
NuScale	United States of America NuScale Power	45

Table 3.3 Typical power requirements for large ships

Ship type	Size	Typical power requirements (MW)
Bulk carrier	320000 dwt	30
Container ship	12000 TEU	80
Cruise ship	100000 dwt	70

Molten salt reactors are possible future candidates for ship propulsion, however, a lengthy period of research and development is necessary for this to happen. Nevertheless, some of their relative merits and disadvantages are discussed in Appendix 6.

The era of nuclear power began with reactors that had low power output, typically tens of MW. Over time, economies of scale have produced the latest generation of power plants which generate up to 4.5 GW of thermal power yielding 1.0 to 1.6 GW electric. These are far too large for shipboard application; however, recently interest in a new type of reactor, the small modular reactor, has arisen. These reactors are much smaller in terms of power output and physical size and are intended to be constructed in a modular fashion involving a significant element of factory build. The underlying economic principle with these modular reactors is that economies of scale are traded for economies of mass production. There are several small modular reactor designs, (Table 3.2), that have appropriate power outputs which are suitable for large ship powering applications (Table 3.3). The small modular reactors identified in Table 3.2 are all are PWR. Moreover, the KLT 40S, VBER 150 and SMR units are derived from submarine reactor plants and have separate

steam generators. The others are integral plants, with the steam generators inside the reactor pressure vessel. Currently, the US Department of Energy is co-sponsoring a project to examine the cost-effectiveness of small modular reactors in the region of 180MW.

### The design and regulatory process

To design and build nuclear-powered merchant ships significant changes to the normal design procedures are required. The process would be driven by a safety case in which the building, operation, maintenance and decommissioning of the ship are the principal features. The safety case would embrace the nuclear, mechanical, electro-technical and naval architectural aspects of the ship design with the safety and integrity of the nuclear plant taking precedence. Within this concept the process of undertaking the safety analysis would typically split the ship into a series of subsystems: some having real and others virtual boundaries. The analysis would consider the effects of a failure occurring in one of the subsystems on the nuclear power plant and vice versa. With such a procedure all parties concerned with the ship would need to be involved: this would include the builder, classification society, flag state and national nuclear administration as well as the duty holder, the ship owner. Moreover, the duty holder

## IN ANY FUTURE MERCHANT SHIP APPLICATION OF NUCLEAR PROPULSION THERE WOULD NEED TO BE COOPERATION BETWEEN IMO AND THE IAEA TO ENABLE THEIR DIFFERENT AND EXTENSIVE SETS OF EXPERTISE TO BE REFLECTED IN DESIGN REGULATION

would be called upon to demonstrate to an independent regulator their ability to operate the ship in a proper and competent manner. Furthermore, the entire process would need to embrace the principles and requirements defined by the International Atomic Energy Agency (IAEA), and adapted for the marine environment; (Appendix 7).

In any future merchant ship application of nuclear propulsion there would need to be cooperation between IMO and the IAEA to enable their different and extensive sets of expertise to be reflected in design regulation. Indeed, the role of land-based nuclear regulators and the views of the flag and port state controls would be critical for any successful implementation of marine nuclear propulsion. In this respect, the trade routes upon which nuclear ships could be deployed and the countries that would be prepared to accept nuclear-powered merchant ships need careful consideration. Moreover, given that ships frequently sail between ports and through territorial waters of different countries, the processes for mutual acceptance and recognition of nuclear certification would become a key element in ship operation and voyage planning. This scenario is further complicated because national land-based nuclear regulators around the world adopt different approaches to demonstrate the

IAEA principles and requirements in their certification processes. Consequently, the port and flag state authorities, in turn, are likely to depend on their national approaches to satisfy themselves that their dependent communities are suitably protected. Notwithstanding nuclear-powered ships visiting ports in the normal course of their duties, issues surrounding the ship's plant maintenance require careful consideration. While normal hull and structural maintenance is unlikely to be a significant issue, any maintenance involving either directly or indirectly the nuclear plant would be of concern within the safety case and the port regulations. Indeed, small modular reactor plants may fit well with these operational and duty holder considerations.

In addition to the requirements imposed on a nuclear-propelled ship, nuclear regulatory arrangements would be applied to the shore facilities used to support the shipboard reactor plants. These arrangements would need to be identified in the appropriate safety cases and levels of security similar to those currently applied to civil nuclear power plants are likely to act as a basis for the consideration.

### NUCLEAR CODES, RULES AND APPLICATIONS

In 1981 the International Maritime Organisation adopted a Code of Safety for Nuclear Merchant Ships, Resolution A.491(XII), and although it has not been implemented it is still extant. However, although being relatively far-sighted at the time of its adoption it would need to be updated to be aligned with the current thinking on nuclear safety. Prior to that Resolution, Lloyd's Register also maintained a set of Provisional Rules for nuclear-propelled merchant ships between 1960 and 1976 and these have recently been revised for use by the marine industry in design studies.

In addition to the full nuclear ship propulsion, there are a set of conventionally powered ships which are used to transport nuclear fuel. These ships have systems and redundancies built into their ship systems and have contributed to the thinking on aspects of merchant marine nuclear safety. In another context, a series of non-powered barges which have nuclear power plants installed on them for use in the Arctic have also contributed in a similar way.

## FROM THE HEALTH PHYSICS PERSPECTIVE THE APPLICATION OF NUCLEAR PROPULSION IS RELATIVELY WELL UNDERSTOOD. GIVEN THE CORRECT DESIGN OF THE SHIELDING AROUND THE REACTOR, WHICH IS A KNOWN TECHNOLOGY, THE EMITTED RADIATION DOSAGE IS VERY LOW

### Ship design and operational considerations

The quantity of fuel used in a PWR reactor is considerably less than the amount of conventional fuel burnt in conventionally powered large ships. For example, the mass of uranium fuel, enriched in  $^{235}\text{U}$  to 3.5%, which would be used by a 12,500 teu container ship undertaking a voyage at 25 knots from Rotterdam to a port on the east coast of the United States of America would amount to a few kilograms. This is in contrast to some 1,550 tonnes of heavy fuel oil that would normally be burnt. Nuclear propulsion, if applied to merchant ships, would therefore have the potential to permit further concepts in ship design to be contemplated: typically in the field of ship speed or deadweight capacity; (Appendix 6).

In the case of a nuclear-propelled ship requiring assistance while on passage, the salvage or rescue processes demand careful analysis. It is unlikely that the standard *Lloyd's Form* would suffice and amendment to or reconstitution of that approach would almost certainly be required. From a machinery perspective such a scenario would be an extreme case, since a nuclear-propelled ship would need to have an auxiliary means of propulsion: particularly if it was fitted with a single reactor plant. Typically, this might be a diesel engine capable of propelling the ship at six or seven knots towards a safe haven. Alternatively, if two independent small nuclear power plants were provided then the need for an auxiliary propulsion diesel engine may be reduced.

From the health physics perspective the application of nuclear propulsion is relatively well understood. Given the correct design of the shielding around the reactor, which is a known technology, the emitted radiation dosage is very low. Indeed, it is claimed that submariners operating nuclear-propelled submarines generally receive much lower doses of radiation than the remainder of the population. This is because when

underwater they are, for much of the time, shielded from the natural radiation sources which come either from space or via the rocks and minerals within the Earth. Nevertheless, a level of monitoring would be required in the context of a crew member trained in health physics and professionally supported from the shore.

### Nuclear plant ownership and safety

A key question relating to merchant ship nuclear powering applications is whether a nuclear plant is purchased or leased by the ship owner. This question embraces consideration of the cost of failures occurring in the system: a situation which has on occasions been extremely expensive to solve in some naval installations. The leasing option of standard nuclear plants, such as small modular reactors, provided they are built in sufficient numbers, would help to distribute these costs between different owners which would not be the case for bespoke units. Furthermore, if this concept were adopted, although not relieving ship owners from their responsibilities as duty holders, it may simplify the execution of those duties by the plant manufacturer undertaking the complete machinery cycle through the design, certification, manufacture, operation and eventual disposal of the propulsion plant. Indeed, the operation and disposal aspects of the nuclear plant life cycle are particularly onerous as both would require detailed knowledge on the part of the ship owner which, at present, few, if any, would possess or wish to possess.

A further issue with regard to nuclear fuel is that non-nuclear nations with shipping interests might wish to take advantage of leasing small modular reactors to prevent them having to acquire nuclear technology and material themselves in order to sail commercial nuclear-powered ships on their trade routes. Such a situation may conceivably create a potential proliferation issue which would need resolution prior to the introduction of these power plants.

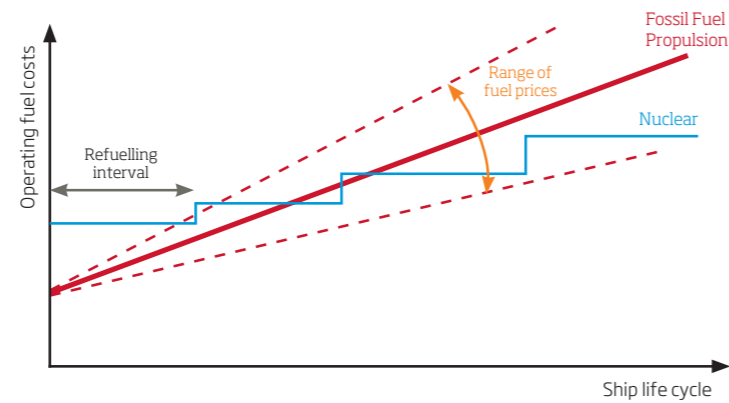

Figure 3.7 Schematic outline for through-life fuel cost analysis

## CONSIDERING THE LIFE CYCLE COSTS OF A SHIP, WHILE THE NUCLEAR OPTION HAS A HIGHER INITIAL CAPITAL COST, THE GRADIENT OF THE CURVE IS MUCH SHALLOWER WITH STEP INCREMENTS WHEN REFUELLING IS REQUIRED

If full plant ownership were contemplated sea staff training programmes, analogous to those operated by the navies who use this technology, would be required. Nevertheless, even with the leasing model, assuming the leaser provides the expert staff to operate the plant, some level of expertise would still be required of nuclear operation by the ship's officers. In both respects the current STCW Code requirements are deficient. Moreover, training would need to have a reactor-specific element with revision periods and recertification being necessary. This would have implications for some current employment arrangements within the merchant navy. Furthermore, shore-based facilities would need a nuclear safety organisation manned by suitably qualified and experienced personnel.

Nuclear safety considerations will drive different shore infrastructure requirements from those currently in place for conventionally propelled merchant ships. These would impact on factories, shipyards, ports and dockyards throughout the whole life cycle of the nuclear propulsion plant and, in so doing, would be a major cost driver for nuclear powered merchant shipping. There would be a number of life cycle requirements that would need to be satisfied: (Appendix 6).

As previously concluded when discussing other related aspects of nuclear propulsion, the small modular reactor concept may be of assistance in simplifying these issues.

### Cost models between nuclear and conventional propulsion

Considering the life cycle costs of a ship, while the nuclear option has a higher initial capital cost, the gradient of the curve is much shallower with step increments when refuelling is required. In contrast, conventional propulsion alternatives have

a lower initial cost but then an operating cost gradient reflecting the fuel consumption during the ship's existence with the average reflecting oil price changes over shorter time intervals; (Figures 3.7). If, however, fuelling for the life of the ship were contemplated and possible for a merchant ship, then the operating fuel costs would become constant; that is, a straight line on Figure 3.7 rather than the saw-tooth characteristic shown in the figure.

A nuclear option would be more difficult to finance because the initial cost has to be paid upfront and the owner becomes a price taker not a price setter: since there is no choice but to take market rates to capture income to amortise the cost of build. Clearly, for the nuclear option other cost elements arise about which little is known at present: these include the cost of finance, maintenance, pilotage, port dues, survey fees and insurance. While these elements are well known for conventionally propelled ships, through-life fuel costs, while reflecting the underlying market trends, are likely to be significantly influenced by future marine fuel policies. This is because higher grades of fuel are, in present terms, considerably more expensive and, furthermore, any introduction of carbon tax will only exacerbate this situation.

### Insurance

The key principles of nuclear liability are established by international treaties which influence national legislation and dictate the scope of operator liability. Countries are either signatories to the conventions or have legislation that adheres to the principles embodied within the conventions. As such, nuclear liability insurance policies must follow relevant national legislation and often require government approval. General non-nuclear risk insurance policies have radioactive contamination exclusions; these fulfil the channelling principle and

Table 3.4 Nuclear liability conventions

OECD (Regional)	IAEA (Global)
Paris Convention 1960	Vienna Convention 1963
Brussels Convention 1963	Revised Vienna Convention 1997
Revised Paris & Brussels Conventions 2004	Convention on Supplementary Compensation 1997

have allowed the establishment of specialist nuclear insurance pools which insure the liabilities associated with nuclear facilities. Table 3.4 shows the conventions in force at present.

Furthermore, there are issues concerning the understanding of nuclear damage for which operators must provide compensation in the event of an incident. Currently loss of life, personal injury, loss of or damage to property and economic loss related to the foregoing are insurable. However, concerns remain: the full insurability of the reinstatement of an impaired environment, use or enjoyment of the environment and preventative measures. Additionally, in the maritime case is the measurement of damage at sea.

Assessing the risk posed by nuclear propulsion is fundamental to the insurance issue and Table 3.5 identifies the nuclear perils, machinery risks and fire protection issues that require assessment.

The issues highlighted in Table 3.5 are principally the risk assessment principles of land-based plants, however, in the marine case the issue is further complicated. It is a mobile platform with limited internal space; has limited maintenance resources; has operational imperative; risks arise from the existence of hostile zones and the attendant risk of a collision, grounding or foundering hazard.

The implementation of insurance principles in the merchant marine environment will differ fundamentally from that which applies to navies where governments take a major role in underwriting the risk. This is unlikely in the merchant service. This, therefore, raises further issues relating to the insurance of nuclear-propelled merchant ships; in particular, the stance of hull and machinery underwriters as distinct from that of P&I Clubs. In the former case, nuclear technology and its mechanical risks are comparatively well-understood and, if not, lend themselves to some level of probabilistic analysis of risk. Cover would be restricted to exclude any physical damage to the vessel's machinery arising from failure of the nuclear plant, certainly that which results in radiation release. Current policy conditions have a standard restriction that excludes that type of event. Some cover may be accessible, but the capacity available to do so would be restricted as underwriters reinsurance programmes mirror that policy exclusion, meaning any insurance share written would be net without the benefit of reinsurance protection. Secondly and more importantly, issues such as ports of refuge, availability of salvage services and formal vessel response plans are key. While hull underwriters would not provide cover for the direct effect of nuclear and radiological effects of reactor failure and consequent contamination it is likely that conventional cover will be in place otherwise, including salvage and sue and

Nuclear perils	Machinery risks	Fire protection
Reactor characteristics	Design authority, systems engineering	Fire hazard
Barriers to release	Adequacy or failure of maintenance - Predictive, preventive, corrective	Plant segregation and compartmentalisation
Reactor protection	Equipment reliability	Fire detection
Radiation protection	Plant protection	Fire suppression
Accident mitigation	Condition monitoring	Fire water supply
Emergency planning	Operating history	Control of hazardous operations, ignition sources
Human factors	OEM support	Control of fire, loading and housekeeping
Regulatory framework	Spare part availability and quality	Fire team
Terrorism and sabotage	Values	Fire drills

Table 3.5 Risk assessment issues

## NUCLEAR PROPULSION HAS CLEAR GREENHOUSE GAS ADVANTAGES AND HAS BEEN SHOWN TO BE A PRACTICAL PROPOSITION WITH NAVAL SHIPS AND SUBMARINES

labour: costs incurred by common interests in the maritime adventure to prevent or mitigate loss. Therefore as insurers assess a nuclear powered risk, it is likely they would require:

- Confirmation that the route assumed has sufficient on-call salvage services.
- That a formal vessel response plan is in place (OPA 90 VRP provisions).
- That the coastal states en-route have formal port of refuge arrangements in place.

As far as the radiation element of risk is concerned, available cover would be limited and expensive. Other solutions would therefore be needed such as accessing existing nuclear pools.

In the alternative case of one member of a P&I Club purchasing a nuclear ship which was subsequently the subject of a claim, this could expose the other members of the mutual club to considerable financial liability. Furthermore, from a P&I perspective, which is third party rather than first-party cover, the problem of cover for radiation is magnified by definition.

### Nuclear propulsion in the future

Nuclear propulsion has clear greenhouse gas advantages and has been shown to be a practical proposition with naval ships and submarines as well in certain specialised ships and demonstrator projects. Considerable experience has been accumulated in the operation of PWR propulsion units, nevertheless considerable difficulty and cost would be incurred in developing a deep sea, international merchant ship today. The difficulties would arise from a number of aspects: design execution and planning, operation, training of crews and shore staff, nuclear regulation, security, public perception, disposal and so on. It has been seen that the concept of small modular marinised reactor plants or molten salt reactors may attenuate many of these difficulties although not dispose of them. As such, it would be prudent to keep a watching brief on the development of these technologies with a view to implementation in the medium to long term.

### Some potential advantages and disadvantages of the technology: Advantages

- Nuclear ship propulsion during operation emits no CO<sub>2</sub>, NO<sub>x</sub>, SO<sub>x</sub>, volatile organic and particulate emissions.
- A significant documented body of experience exists in the design and safe operation of shipboard nuclear propulsion plant: particularly in the case of PWR designs.
- The nuclear power plant concepts are suitable for merchant ship propulsion.
- Small modular marinised reactor or molten salt reactor plants may attenuate many of the difficulties associated with nuclear propulsion although they will not dispose of them.
- Nuclear propulsion would offer further flexibility for merchant ship design and operational planning with respect to ship speeds, hull form and ship numbers deployed on a route.
- The costs of the fuel are initially paid for along with the reactor plant and thereby remove exposure to price fluctuations for significant periods of operational service.

### Disadvantages

- The conventional methods of planning, building and operation of merchant ships will need complete overhaul since the process would be driven by a safety case and systems engineering approach.
- There would be a number of additional constraints imposed on the ship design and operation.
- In contrast to the second advantage, there is a relatively small number of nuclear propulsion experts at all levels and this will cause competition with land-based installations.
- In contrast to conventional methods of ship propulsion, there are further issues surrounding the deployment of nuclear technology which require resolution. These include international regulation; public perception; initial capital cost and financing; training and retention of crews; refuelling and safe storage for spent fuel; the setting up and maintenance of an infrastructure

## LITHIUM-AIR BATTERIES MAY OFFER THE PROMISE OF A SIGNIFICANT ENERGY DENSITY MULTIPLIER ABOVE THE CURRENT BEST PERFORMANCE FROM LITHIUM-ION BATTERY TECHNOLOGY

- support system; and emergency response plans.
- Insurance is a major issue for merchant ships that would require careful consideration and resolution for merchant ships.
  - The non-technical issues need resolution before nuclear propulsion could become a realistic option for international trade routes. This would take time to implement and among these issues number some national prejudices against nuclear-propelled ships.
  - Nuclear propulsion, due to these constraints, should only be considered as a medium- to long-term option.

usually to be sustained for some days. However, new technologies in this or any other area need care in their introduction in terms of performance and reliability.

New battery chemistries include metal-sulphur, where the metal is magnesium, sodium or lithium or metal-oxygen – also referred to as metal-air where the metal is zinc, lithium or sodium. Currently the leading contender is the lithium-air battery. Theoretically a lithium-air battery can liberate 11,780 Wh from the oxidation of one kilogram of lithium. Unlike most other batteries, which carry the necessary oxidant within the battery, the lithium-air battery draws in oxygen from the atmosphere during discharge and liberates it during charging. Hence, lithium-air batteries can be very light but require a means of supply and removal air: analogous to a fossil-fuelled engine.

### 3.6 Batteries

The lead acid battery, the zinc-carbon dry cell and the nickel-cadmium battery have been the most common battery types throughout much of the past 150 years. During that time they have evolved little. As storage media they variously exhibit low energy density, low power density or suffer from other weaknesses. These include an unacceptable self discharge rate or a *memory effect* in which the maximum energy capacity of a partially discharged battery is reduced with each re-charge. Consequently, these attributes do not commend them practically or economically for large-scale use as an alternative means of power for marine propulsion.

In recent years, there have been significant improvements, (Figure 3.8), and energy and power density are becoming much higher. These newer battery types can be recharged more quickly; have lower self discharge rates and are free of a *memory effect*.

Although they provide better performance, these newer battery types do not as yet generally satisfy the marine propulsion needs. In this sector significant power is required and for all but the shortest of coastal voyages, the power output has

Despite the high theoretical energy density of lithium-air battery technology, the currently achieved performance is below that initially expected from a practical device; that is, 2,000 Wh/kg. Nevertheless, the development of lithium-air batteries is at an early stage and has encountered both successes and setbacks; including problems with capacity fading, cycle life, a noticeable mismatch in charging and discharge voltage as well as in limitations in the rate of oxygen diffusion. Given that many research groups are working in this technical area, lithium-air batteries may offer the promise of a significant energy density multiplier above the current best performance from lithium-ion battery technology.

Despite the potential of lithium-air batteries, many companies in Japan, China, South Korea, Europe and the USA consider that lithium-ion battery performance can be significantly improved. There is, therefore, the provision of significant research funding for improving lithium-ion battery performance as well as developing other post-lithium-ion battery technologies.

A report (IDTechEx 2011) explored the pattern of patenting activities in the advanced

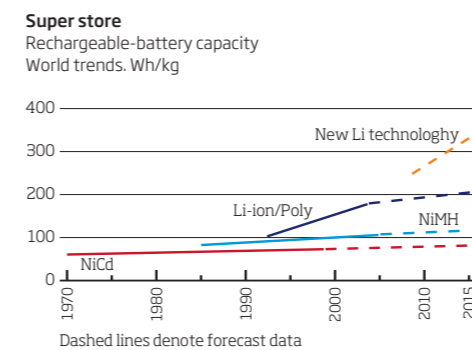

Figure 3.8 World trends in rechargeable battery capacity (Source: Avicenne)

energy storage sector over the prior seven-year period. Their report showed that four companies have approximately 8,500 applications between them which indicate an intense level of activity in the field of energy storage. In addition, many small, typically university-derived, spin-off companies are pursuing narrowly focused innovations and some of their efforts may prove significant in the future.

With regard to raw material availability, world deposits of lithium are comparatively limited. There is a consensus that global reserves of lithium are between 10–11 million tonnes with the majority vested in Chile (IEEE). Therefore, if a growing adoption of lithium-based batteries takes place the rate of consumption of the limited global stock and costs of lithium may be expected to increase. An alternative battery technology that may address this risk is the magnesium-ion battery. Active research programmes are underway and there are optimistic reports that rechargeable magnesium-ion batteries, using the best new cathode materials, could deliver a threefold increase in energy density compared to lithium-ion: about the same improvement as that forecast for lithium-air. Moreover, magnesium is more common than lithium. Its crustal abundance is 29,000 ppm whereas for lithium it is 17ppm and in

the oceans the abundance of magnesium and lithium is 1,290 ppm and 0.17 ppm respectively.

Estimates forecast that by 2030 the cost of both lithium-air and lithium-ion battery packs will be similar and extra large battery packs suitable for marine propulsion may cost somewhat less per kWh. Although magnesium currently costs about 1/20 of that of lithium, there are other costs in the construction of a battery. The cost of recharging will be linked to the cost of electricity needed to refill the batteries. In the case of marine propulsion this could be provided by a range of renewable sources feeding the national grid into the port.

A new battery technology spun-out of Stanford University (Stanford 1&2) is the all-electron battery which is claimed to have much higher power and energy density than is available from a chemical battery together with a significantly lower cost/kWh.

In a related technology, energy storage based on super-capacitors has been implemented on a small 22 m passenger ferry, the *Ar Vag Tredan*; (Figure 3.9). This ship makes short voyages of around 2.5 nm in sheltered waters at a maximum speed of 10 knots. The energy storage in the super-capacitors is enough to permit



Figure 3.9 *Ar Vag Tredan* super-capacitor driven ferry [Courtesy stx-Lorient]

one round trip and recharging is done during unloading and loading of the passengers from shore-power. The recharging takes four minutes via a 400V supply at the stem of the ferry. In addition, photovoltaic panels contribute to the electrical energy used by navigation equipment.

#### Some potential advantages and disadvantages of the technology: Advantages

- Battery-based propulsion of merchant ships is beneficial from the CO<sub>2</sub>, NO<sub>x</sub>, SO<sub>x</sub>, volatile organic and particulate emissions points of view since during operation none occur.
- Batteries, by virtue of the rapidly developing technology surrounding them, offer a potential solution for the propulsion of smaller ships in the medium to long term.
- Batteries in conjunction with other modes of propulsion may offer a potential hybrid solution for the propulsion of small- to medium-sized ships.

#### Disadvantages

- At present, the size of the necessary battery pack would preclude their use as the sole means of propulsion in all but the smallest of ships on short sea voyages.
- Full battery propulsion must await further technical development and even then it is likely to be confined to the smaller ship end of the market.
- The battery pack requires replacement when it reaches its life as determined by the total number of charge/discharge cycles.

## 3.7 Fuel cells

Invented in 1838, the fuel cell predates the four stroke spark ignition engine and the diesel engine. For more than a century it was little more than an engineering curiosity as there was neither the need nor the means to develop it. Interest was rekindled in fuel cells as the space race progressed for three reasons: their mass is low, the only exhaust product is water and materials technology had developed sufficiently to enable their promised high efficiency to become a reality.

Fuel cells, like a battery, produce energy from an electro-chemical process rather than combustion. Fuel cells have no moving parts but do require additional support plant such as pumps, fans and humidifiers. Two reactants, typically hydrogen and oxygen, combine within the fuel cell to produce water, releasing both electrical energy and some thermal energy in the process. Unlike a conventional battery in which the reactants consumed in the energy conversion process are stored internally and eventually depleted, the reactants consumed by the fuel cell are stored externally and are supplied to the fuel cell in an analogous way to a conventional diesel engine. Hence a fuel cell has the potential to produce power as long as it has a supply of reactants.

Many values are quoted for the efficiency of a fuel cell and all should be treated with caution and considered in context. The fuel types, storage conditions, inclusion of a reformer and type of output power must all be considered. A comparison of fuel cell performance with that of diesel engines should be not be based on simply considering the engines themselves: the whole propulsion chain should be taken into account particularly as diesel engines produce rotary output and fuel cells DC electrical output. One view is to consider the theoretical maximum efficiency of a heat

Figure 3.10 Theoretical heat engine and fuel cell efficiencies [Larminie and Dicks 2000]

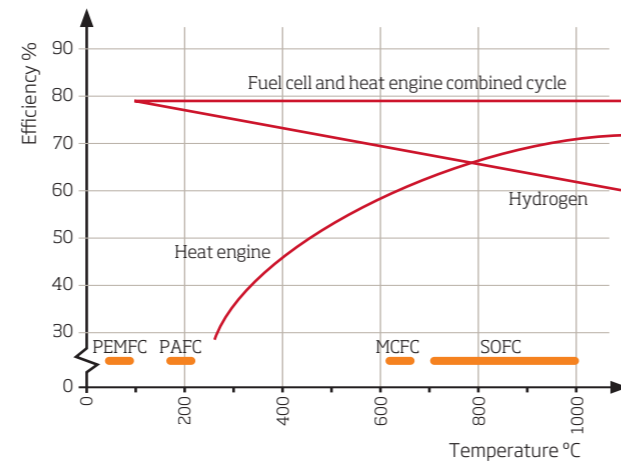

engine and a fuel cell; Figure 3.10. The heat engine limit is calculated using the Carnot cycle with a lower reservoir temperature of 100 °C. The fuel cell is supplied directly with gaseous hydrogen and oxygen, not air. With the exception of fuels cells used in space and submarines, air is substituted for oxygen as one of the reactants. Using air, with the normal 21% oxygen content, reduces efficiency but this is offset by the free supply as in the case of diesel engines.

The high temperature fuel cells have the potential to achieve efficiencies similar to if not better than those of large marine diesel engines, especially if they are combined with a steam plant to make use of their thermal output. Table 3.6 shows an alternative evaluation together with comparative specific powers and power densities. While efficiencies are similar, diesel engines significantly outperform fuel cells in terms of specific powers and power densities.

In Table 3.6 the values are roughly estimated and based on available product documentation for the fuel cells as well as DNV's *Internal Report No. 2010-0605* for the combustion engines. Estimated electric efficiencies are based on the lower heating value of the relevant fuel and specific power and power density are compared for two types of fuel cell power packs and two types of internal combustion engine.

The proton exchange membrane fuel cell is classified as low temperature and is being developed for the automotive market, among other applications, in the 1-300 kW range. The phosphoric acid fuel cell is also low temperature and has a higher power band, typically 10kW to 1MW, but is not suitable for marine applications due to the nature of its electrolyte. The direct methanol fuel cell is a third low temperature fuel cell which uses methanol as its hydrogen source. The high temperature fuel cells, molten carbonate and solid oxide fuel cells, can be built for much larger powers from a few kilowatts up to 10MW and, therefore, are candidates for main propulsion as well as auxiliary power generators.

A major issue for fuel cells is their fuels: oxygen can be obtained from air but hydrogen is more of a challenge. One option is a direct supply of hydrogen, but at present bulk storage is problematic, (Section 3.9), and the infrastructure is lacking. The external reformation of diesel is an alternative and is seen as a viable alternative for the military which uses high distillate fuel. However, it is more challenging to reform the low-cost, heavy fuel oil commonly used by the merchant marine. A more realistic shorter-term scenario for marine fuel cell power generation would be operation by natural gas. A number of high temperature fuel cells are capable of operating directly on natural

gas by converting methane into hydrogen within the fuel cell itself; termed internal reformation. The disadvantage is that carbon in the fuel is converted into CO<sub>2</sub>.

Until recently, fuel cell development in the marine field has been limited, the exception being Air Independent Propulsion for submarines and Autonomous Underwater Vehicles. The first practical application of a fuel cell for motive power in a submarine was in 1964 when Allis-Chalmers produced a 750kW fuel cell for the Electric Boat Company to power a one-man underwater research vessel. More recently, Siemens, at the behest of the German government, developed a successful 120kW PEMFC fuel cell for the German navy. A pair of these units is used for the AIP pack in the Class 214 submarines which were constructed for a number of navies, including those of South Korea and Greece. The Class 209 boats, which were mainly produced for export, are offered with a 6m long AIP extension and retrofitting to existing boats is an option. Both submarine types carry liquid oxygen, internally for the 209 and externally for the 214, and store the hydrogen in external metal hydride tanks. Fuel cells are also used for autonomous underwater vehicles; the Hugin series, built by Kongsberg, uses an aluminium-oxygen semi-fuel cell. The hydrogen peroxide fuel, electrolyte and the anodes reportedly require frequent replacement.

Some small ferries have been used to demonstrate fuel cell technology. At Expo2000 the *msWeltfrieden* was fitted with a 10kW PEM fuel cell, where the hydrogen was stored in metal hydride. Since 2008 ZEMSHIPS' (zero emissions ships) *Alsterwasser*, a 100-person passenger ferry, has been in use on the Alster River in Hamburg. This ferry is powered by a pair of 48kW PEM fuel cells using air and hydrogen, the latter being stored as pressurised gas.

The European Commission under the 5th, 6th and 7th Framework programmes has funded studies, research and demonstrators. Early projects included fuel

cell technology in Ships (FCSHIP) (2002-2004) and New-H-Ship (2004-2006). These programmes assessed the technical feasibility of installing fuel cells on ships followed by a number of demonstrator projects (EC 2002-2006). The projects had a strong representation from the Nordic countries, including Iceland, who saw fuel cells as a catalyst for developing a hydrogen economy. Nordic countries, in particular Iceland, have huge reserves of hydro- and geothermal power with which to produce *green hydrogen*: that is, production without significantly adding to the greenhouse gas burden. A more recent project moved away from hydrogen as a fuel, MC-WAP - molten-carbonate fuel cells for waterborne applications (2005-2011). The purpose of this initiative was to study the application of the molten carbonate fuel cell technology onboard large vessels, such as Ro/Pax, Ro/Ro and cruise ships. This included the design, construction, installation on board and testing of a 500 kW auxiliary power unit, powered by MCFC and fuelled by diesel oil. Project METHAPU (Validation of renewable methanol based auxiliary power systems for commercial vessels) (2006-2010) developed a methanol/air SOFC for use in marine applications. A prototype 20kW unit, produced by Wärtsilä, was installed aboard the Swedish Wallenius Lines car carrier *mv Undine* to assist in auxiliary power production. So far the programme has demonstrated the ability of SOFC technology to withstand the demands of the marine environment and data analysis is proceeding. While methanol requires a number of additional precautions, when compared to conventional fuels, it was demonstrated that it could safely be used without major deviations from operating procedures or ship constructional methods. Moreover, it was shown that the use of this fuel would present no greater risk to the ship, its occupants or the environment than would normally be attributed to conventional marine machinery. PaFCXell is a German-funded project currently underway to investigate the integration of small PEM fuel cells into the auxiliary power generation grid of a cruise ship.

Electric power generator	Electric efficiency (%)	Specific power) (kW/m <sup>2</sup> )	Power density (W/kg)
Fuel cell (MCFC)	45-50	3	15
Fuel cell (HTPEM)	≈ 45	30	60
Marine diesel (4 stroke)	40	80	90
Marine gas (4 stroke)	45	80	90

Table 3.6 Characteristic properties of two fuel cell types and two types of combustion engines. [DNV 2012]





Figure 3.11 The hybrid propulsion ship mv *Viking Lady*  
© Viking Lady

FellowSHIP is a joint industry research and development project with the aim of developing and demonstrating hybrid fuel cell power packs, especially usable for marine and offshore use: the partners include two major diesel manufacturers, Wärtsilä and MTU, as well as DNV. The FellowSHIP project has successfully installed a 330 kW MCFC operating on LNG aboard the Norwegian shipping company Eidesvik's 6,200 dwt hybrid propulsion *Viking Lady*; (Figure 3.11). This fuel cell operates in conjunction with four generator sets that can run on either diesel or LNG. They have successfully demonstrated smooth operation for over 7,000 hours which suggests that fuel cells can be adapted for stable, high-efficiency, low-emission onboard operation. When internal consumption was taken into account, the electric efficiency was estimated to be 44.5% with no NO<sub>x</sub>, SO<sub>x</sub> and PM emissions detectable. If heat recovery was enabled, the overall fuel efficiency was increased to 55%; however, there remains potential for further increasing these performance levels

(DNV, 2012). Nevertheless, fuel cells, due to the Nernst equation, cannot use all the fuel since the concentration of the reactants dictates the voltage. So essentially 15 to 20% of the fuel (hydrogen) is left in the anode outlet and should be used otherwise.

The part load efficiency of fuel cells, in contrast to diesel engines and gas turbines, frequently shows an increase at lower loads. However in particular with external, and to a lesser extent, with internal reforming, the supply of the fuel could impede dynamic loading and fast transients.

In the longer term however, it is the operating environment and adoption of electric as opposed to mechanical transmission that is expected to change in favour of the fuel cell. Indeed, *green hydrogen*, generated using renewable energy ashore and consumed in hydrogen-fuelled fuel cells onboard ships, may offer a solution. In such an ideal operating environment, the benefits of fuel cell technology could be fully exploited.

#### FUEL CELL APPLICATIONS

The US Navy, US Coast Guard and other navies have undertaken a number of studies for the installation of fuel cells. An additional benefit for the military is that fuel cells are very quiet compared to diesel engines. A detailed concept study was conducted into replacing a diesel generator set for the US Coastguard's USCGC *Vindicator* by a 2.5MW MCFC fuel cell. The package included a fuel reformer for low sulphur NATO standard F-76 distillate fuel: the reformer separated the fuel into hydrogen and carbon dioxide. The US Office of Naval Research developed a 2.5MW ship service fuel cell which was based on a MCFC and will reform naval fuel. The goal was to achieve their objective using commercial or near commercial technologies and for it to be highly reliable, maintainable and self-contained with respect to water and energy balance. The steam reformation of NATO F-76 was demonstrated for over 1,400 hours and has fuelled a sub-scale MCFC for 1,000 hours. It also demonstrated adequate tolerance to salt, shock and vibration.

AN ADDITIONAL  
BENEFIT FOR  
THE MILITARY IS  
THAT FUEL CELLS  
ARE VERY QUIET  
COMPARED TO  
DIESEL ENGINES



Figure 3.12 The Flettner rotor ship *Baden-Baden*, formerly the *Buckau*.  
Image courtesy of Wikimedia Commons

#### Some potential advantages and disadvantages of the technology: Advantages

- Fuel cell technology has a potential for ship propulsion in the medium to long term.
- At the present time encouraging experience is being gained through auxiliary, hybrid and low power propulsion machinery.
- For marine propulsion, the high temperature solid oxide and molten carbonate fuel cells show most promise. For lower powers, the low temperature proton exchange membrane fuel cells are better suited.
- Methanol is a possible alternative fuel.
- Fuel cells produce a DC electrical output and are, therefore, suited to ships with electrical transmissions.
- Fuel cells have no moving parts and consequently are quieter than conventional machinery.
- If fuelled with hydrogen, they emit no carbon dioxide from the ship.
- They require clean fuels and so do not emit SO<sub>x</sub>, but also they are low-temperature devices and emit no NO<sub>x</sub>.

#### Disadvantages

- Although hydrogen is the easiest fuel to use this would require a worldwide marine infrastructure to be developed for supply to ships: perhaps adjacent to an automotive sector.
- The use of more conventional marine fuels in fuel cells would present problems and necessitate complex onboard pre-processing to take place. They would in this case be a significantly more expensive way of generating electricity than conventional methods.
- Fuel cells produce DC electrical output and, hence, are not so suited to ships with mechanical transmission systems.
- Fuel cells have lower specific powers and power densities than diesel engines.

## 3.8 Renewable energy sources

### Wind energy

Methods that use the wind to provide energy to drive ships include a variety of techniques. Typically these embrace Flettner rotors, kites or spinnakers, soft sails, wing sails and wind turbines.

Soft sails are historically the oldest of these techniques, predating the use of mechanical forms of propulsion. While some remarkable sailing passages were made, particularly in relation to the tea clippers in the 19th and early 20th centuries, soft sail-derived power was dependent on the availability of the wind and relied on the skill of seamen to make the best use of the available weather. However, to some extent the mimicking of these skills lends itself to automated control systems today.

The Flettner rotor made its appearance in the 1920s as seen in Figure 3.12. The Flettner rotor utilises the Magnus effect of fluid mechanics, where if wind passes across a rotating cylinder a lift force is produced. This force has a linear relationship with wind speed and, unlike conventional sails or aerofoils, a true cross-wind relative to the ship will produce a useful forward thrust at any ship speed even when this is greater than the wind speed. For a large ship, Flettner rotors can provide a small but significant proportion of the total propulsive power. However, the vorticity produced by a rotor is complex and a full understanding of the mechanisms is still evolving, principally through the means of computational fluid dynamics. The vorticity in the wake of a rotor raises the issue of vortex interaction if more than one rotor is fitted to a ship. This requires exploration for a particular design, particularly with respect to any interference with the ship's superstructure or high freeboard under certain wind conditions.

WHEN POWER IS PROVIDED BY WIND SOURCES THIS WILL TEND TO ALTER THE DESIGN BASIS OF THE PROPELLER. SOME ALLOWANCE OF THE AVERAGE POWER TO BE DERIVED FROM THE WIND, THEREFORE, NEEDS TO BE TAKEN INTO ACCOUNT IN THE PROPELLER DESIGN IN ORDER TO OPTIMISE THE OVERALL PERFORMANCE OF THE SHIP

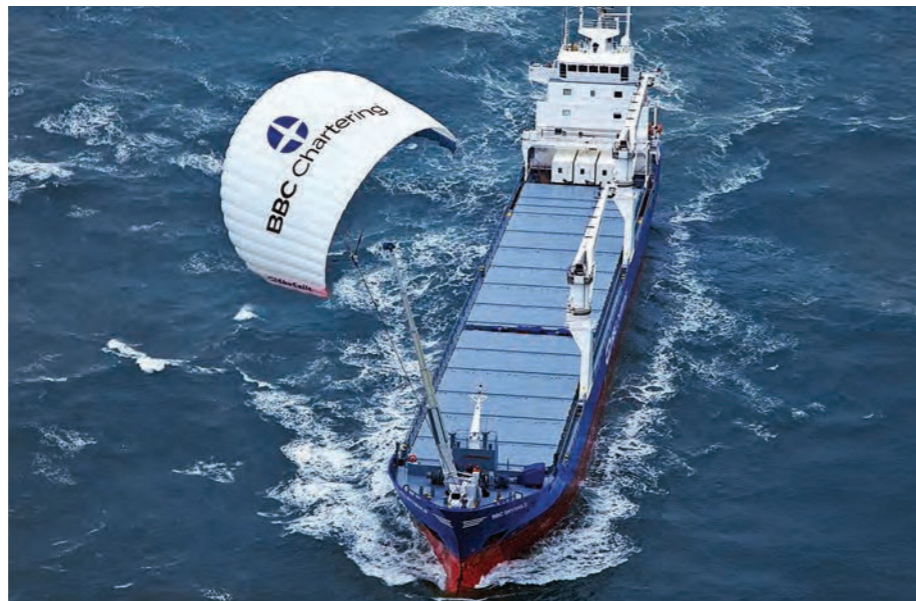

Figure 3.15 Application of a kite to assist propulsion © Sky Sails

In the case of the *Baden-Baden* two rotors, 18m high and 2.7m in diameter, were fitted in place of the previously fitted three masts. It was found that the ship could sail much closer to the wind than when previously under sail and in 1926 the ship made a successful crossing of the Atlantic Ocean. Subsequently, another 3,000-tonne cargo-passenger was ordered, the *Barbara*, and sailed between Hamburg and Italy for six years. In this case the rotors differed in that they were 17m high and 4m in diameter, rotating at 150rpm and they were three in number. The problem, however, remains that if there is no wind the ship becomes becalmed in the absence of some other form of power: this, however, is a problem for all types of ship where wind is a source of power.



Figure 3.13 *E-Ship 1* © Roberto Smera

More recently, the *E-Ship 1*, a 10,500 dwt vessel shown in Figure 3.13, was built in 2010. In addition to being fitted with two 3.5 MW diesel engines, *E-Ship 1* has four Flettner rotors: two aft, port and starboard, and two forward behind the bridge and accommodation structure. With this arrangement the ship is capable of a service speed of 17.5 knots.

Apart from leisure craft, the principal usage of sail power today is in some aspects of the luxury cruise market or with sail training ships. However, wing sails have been used and a number of trials have been undertaken in recent years. The *mv Ashington*, Figure 3.14, provides an example of wing sail application and sea trials have shown that benefit can be obtained in the



Figure 3.14 *mv Ashington* wing sail application © Mercator Media 2013

context of an augmentation of propulsive power. There are, however, fluctuations in the loadings derived from the sails and while there is a broad linearity of resultant load when considered in the context of wind speed, there can be significant scatter in the results and this has to be taken into account in the control system design. Fluctuations of this nature require attention in the fatigue and structural design of the installation.

Soft sails and kites, Figure 3.15, have been explored experimentally on modern merchant shipping. Their contribution in the ahead and leeway directions is a function of the relative magnitude and direction of the ship and wind speed.

In the case of wind turbines mounted on ships for the generation of electric power, similar considerations apply in that an adequate differential wind speed over the turbine rotor is required. For small ships and leisure boats gyroscopic couples from a wind turbine also need to be taken into account to prevent stability issues in a seaway.

When power is provided by wind sources this will tend to alter the design basis of the propeller and lead to an off-design performance in some operating conditions. Some allowance of the average power to be derived from the wind, therefore, needs to be taken into account in the propeller design in order to optimise the overall performance of the ship.



Figure 3.16 An image of a combination of solar and wind energy from Solar Sailor © Solar Sailor 2013

### Solar energy

Photovoltaic methods offer an approach for limited amounts of power generation on board ships and trials have demonstrated that some benefit is available for auxiliary power requirements. However, the maximum contribution is small when compared with the power required to drive the ship (Mackay 2011).

The average raw power of sunshine is a variable depending upon the latitude and the angle at which the photovoltaic cell is positioned relative to the sun. In the United Kingdom, the average value over the year is about 100 W/m<sup>2</sup> on a horizontally mounted surface. Throughout the world the variation in power availability under average cloud cover is typically between 87 W/m<sup>2</sup> in Anchorage to 273 W/m<sup>2</sup> in Nouakchott on the coast of Mauritania. However, the effect of cloud cover is significant in terms of the energy that can be derived from the sun using this technology. Consequently, weather conditions and position on the planet are significant influencing factors in developing the potential of solar power.

There is design potential to adopt a range of rigid and flexible technologies. However, the principal constraint is the ability to find a large deck surface area on the ship which does not interfere with cargo handling or other purposes for which the ship was designed. In this context car transporters are an obvious candidate for the application of this technology.

Resulting from the laws of physics, this technology inherently suffers from low

generation capability, even if efficiency could be improved to 100% (Mackay 2009). As such, coupled with a maximum attainable specific power from the sun at given global locations and the generally limited available deck area suggest that the power attainable would only be sufficient to augment the auxiliary power demands.

Conceptual proposals have been made to increase the available area for energy capture from the sun by arrangements of solar panels on mast-like structures arranged along the deck, sometimes in combination with wind augmentation; (Figure 3.16). Again, the number of masts that can be accommodated is dependent on the type of ship and its duty as well the attitude of the panels with respect to the sun in order to maximise the panels' effectiveness. It is likely that these arrangements will only be effective in the sense of an augment to auxiliary power requirements.

### Some potential advantages and disadvantages of the technology:

#### Advantages

- Power derived from the wind is free from exhaust pollutants.
- Partial propulsion benefits can be achieved through wind-based methods.
- Solar power has been demonstrated to augment auxiliary power.

#### Disadvantages

- Wind power systems rely on the wind strength to be effective.
- The use of some wind-based systems rely upon adequate control system technology being installed on board the ship.

## HYDROGEN IS A POTENTIAL ALTERNATIVE FUEL FOR SHIP PROPULSION.

- iii. Applications involving power derived from the wind are limited to the augmentation of propulsion unless a full return to sail is contemplated for specific applications.
- iv. While a return to full sail propulsion is possible, this may have a number of adverse commercial and financial implications in some instances in terms of voyage times, number of ships required, etc.
- v. Solar power availability is global position dependent.
- vi. Solar energy is feasible as an augment to auxiliary power but photovoltaic processes are inherently of low effectiveness, even under the best of conditions, and require a significant deck or structural area upon which to place an array of cells.

### 3.9 Hydrogen

Hydrogen is a potential alternative fuel for ship propulsion. It requires energy to produce hydrogen and this could come from either conventional fuels or non-fossil sources such as wind, hydro-electric or nuclear. Currently, all hydrogen used in industry is made from natural gas. In the case of conventional sources, in order to be effective in CO<sub>2</sub> reduction the issue of whether the greenhouse gas emissions are simply being transferred from a source on the sea to one on land has to be adequately resolved as carbon sequestration and storage has yet to be demonstrated at scale.

Veldhuis (2007) assessed the application of liquid H<sub>2</sub> to a concept propulsion study of a high speed container vessel designed for high value, time-sensitive goods as an alternative to air freight. Liquid hydrogen benefits from a much higher specific heat per unit weight than conventional fuels but requires a much greater volume for storage. If stored at 700 bar pressure the storage tanks would be at least six times bigger than for conventional fuels. New ship designs

would require increased above water structures to accommodate this storage capacity and, therefore, this may create difficulties in retrofitting ships to use liquid hydrogen fuel.

A significant advantage of liquid H<sub>2</sub> fuel is that it generates no CO<sub>2</sub> or SO<sub>x</sub> emissions to the atmosphere. NO<sub>x</sub> emissions can be managed as for any other fuel, but where hydrogen is burned in a fuel cell, there are no NO<sub>x</sub> emissions. However, there are ship safety design issues which need resolution. These centre on the flammability of the fuel when stored; the necessary pressure vessels and cryogenic systems that would be required. These issues are similar to, but more extreme than, those already required and which have been solved with LNG or LPG ships.

Similarly to LNG fuelling, for liquid hydrogen to become a realistic possibility for deep sea ship propulsion, a liquid H<sub>2</sub> supply infrastructure would need to be developed. A further utilisation of hydrogen fuels might be in conjunction with fuel cell usage; Section 3.8.

#### Some potential advantages and disadvantages of the technology:

- Advantages**
- i. Liquid H<sub>2</sub> generates no CO<sub>2</sub>, or SO<sub>x</sub> emissions to the atmosphere originating from the ship.
  - ii. Uses land-based sources of power for creation.
  - iii. Hydrogen can be used in fuel cells and internal combustion engines.
  - iv. *Burning* it produces a large feed-stock in fresh water.

#### Disadvantages

- i. Largely untried in the marine industry for propulsion purposes.
- ii. Hydrogen has some safety issues that need resolution.
- iii. It has a low energy density.
- iv. Would need a hydrogen supply infrastructure to make it viable for the marine industry.

### 3.10 Anhydrous ammonia

Anhydrous ammonia is a dangerous, poisonous gas, but it can be compactly transported as a liquid in pressurised tanks at about 30 bar or cryogenically in unpressurised tanks. This is a bulk industrial commodity, and can be burned in both diesel engines and gas turbines. While it emits no carbon dioxide at the point of use, it cannot be considered 'carbon-free' unless its manufacture (on land) does not emit carbon dioxide, which is not currently the case. Its calorific value is about half that of diesel, so storage requires some adaptation but much less than carrying hydrogen.

The coldness of the ammonia can be used to cool the inlet air to the prime mover to 5°C. As previously discussed in the context of LNG, for a gas turbine this can be particularly effective.

The corrosion sensitivity of copper alloys to ammonia is well known, but the sensitivity of steels to ammonia stress corrosion cracking can be controlled by adding a small amount of water (0.2%) to the ammonia (Loginow 1989).

#### Some potential advantages and disadvantages of the technology

- Advantages**
- i. No greenhouse gas emissions on board ship.
  - ii. No sulphur emissions.
  - iii. There is mature, bulk manufacture of 130 million tonnes a year.

#### Disadvantages

- i. Handling requires new procedures for dangerous gases.
- ii. New bunkering facilities and infrastructure required worldwide.
- iii. Some additives needed to promote ignition in diesel engines.
- iv. Made from natural gas, so always more expensive than LNG.
- v. There are some corrosion issues which need to be overcome.

### 3.11 Compressed air and liquid nitrogen

Compressed air and liquid nitrogen are two further alternative sources of energy storage for ship propulsion. Both require energy to produce or compress in the cases of liquid nitrogen and air respectively. As with hydrogen the necessary energy requirement can be derived from conventional and non-fossil fuels or renewable sources together with the same caveats. Furthermore, being energy storage media they exhibit similar system behaviours to those of the more conventional battery or capacitor technologies.

An assessment of the usefulness of these storage media will depend on their system mass for the amount of energy required between recharge. However, inherently these are low energy density propulsion methods. To successfully deploy these media it would be necessary to include pressure vessels and, in the case of liquid nitrogen, cryogenic systems: both well known technologies in land-based systems. In the case of compressed air there would be the attendant danger of blast if a tank for some reason ruptured. However, the technology for protecting compressed gas tanks from shock, in for example a collision scenario, is well known in the container and railway industries. Corrosion of pressurised tanks in a marine environment may also present a problem and suitable inspection regimes would be essential.

On land, compressed air energy storage is used only in conjunction with diesel or gas turbines: the compressed air feed means that the pre compressor is not needed, and therefore the prime mover can operate with approximately 15% greater efficiency.

With compressed air storage, the considerable amount of energy used to compress the air is not all stored on board the ship as the hot, compressed air is allowed to cool to room temperature.

This heat energy is lost. Therefore, to obtain substantial energy from the pure expansion of this stored compressed air (without using it in the compressor of a prime mover), low-grade heat must be provided to supply the needed energy. Sea water heat exchangers are a possible source of this heat. The same situation arises with liquid nitrogen: a source of low-grade heat is required to drive the evaporation and create a useful pressure.

Being energy storage media they have the advantage of generating no CO<sub>2</sub>, NO<sub>x</sub> or SO<sub>x</sub> emissions to the atmosphere when in use on board the ship.

**Some potential advantages and disadvantages of the technology:**  
**Advantages**

- i. Compressed air and nitrogen generate no CO<sub>2</sub>, NO<sub>x</sub> or SO<sub>x</sub> emissions to the atmosphere when in use on board a ship.
- ii. Uses land-based sources of non-fossil fuel power for creation.
- iii. Tank storage technologies are well understood.

**Disadvantages**

- i. A supply infrastructure and distribution network would need to be developed.
- ii. The size, pressure rating and cryogenic capabilities, in the case of nitrogen, of the ship storage tanks will determine the amount of energy storage and hence usefulness of the concept.
- iii. There is an attendant blast risk with high pressure tanks should fracture be initiated.
- iv. Corrosion can be a significant issue in salt-laden environments with high pressure tanks.
- v. Largely untried in the marine industry for propulsion purposes.
- vi. These are low energy density methods of energy storage and, therefore, are likely to be suitable only for short sea routes.



**Serial hybrid system**

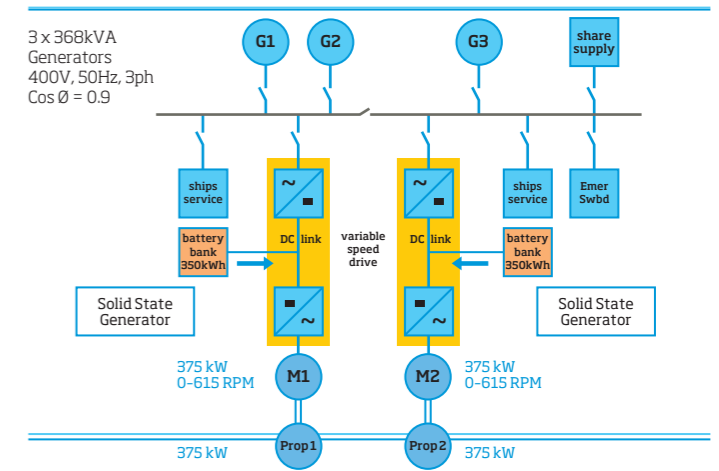

Figure 3.17  
Propulsion plant of the Raasay hybrid ferry [Courtesy CMAL]

**3.12 Hybrid propulsion**

Hybrid propulsion is an option where one or more modes of powering the ship can be utilised to optimise performance for economic, environmental or operational reasons. Most commonly today the different powering modes feed a common electrical bus bar from which power can be drawn for various purposes. This, however, need not necessarily be the case since many examples of mechanical linkages between independent power sources have been designed and operated in ships, both past and present. Typical examples are to be found with 10,500 dwt *E-Ship* which was built in 2010, Section 3.8, and COGAG and CODAG naval vessels. The Royal Navy's Type 45 destroyer's is another typical example where an integrated electric propulsion system comprising two WR21 gas turbine alternators and two diesel-electric generators supply propulsion electric induction motors at 4.16 kV. Similarly, with the *Viking Lady* in its deployment of dual-fuel generator sets and a fuel cell; Section 3.7.

The choice for a hybrid option can also be location dependent. For example, the new buildings to the order of CMAL for the inter-island ferry service between the Islands of Skye and Raasay in the Hebrides where there is a strong desire to preserve the environment. In this case the propulsion system comprises diesel engines and a system of batteries. In this case the batteries can either be recharged from the diesel engines or from the land-based

grid when the vessel is moored in harbour for the night. On low load sailings the ship can also be operated by only the batteries feeding the electric motors; (Figure 3.17).

In this case the principal reasons for considering hybrid propulsion were:

- greater redundancy
- reduced fuel consumption
- reduced impact of CO<sub>2</sub> emissions and other pollutants
- uncertainty of future fuel costs
- insurance against increasing environmental legislation
- noise reduction
- possibility to operate in zero emission mode when the ship is in port
- lower maintenance

It is estimated that this hybrid diesel-electric propulsion system will use at least 20% less fuel for the ship than an equivalent diesel-mechanical propulsion system operating at design speed with the vessel fully loaded. This fuel saving, in overall terms, relies on the shore power component being derived from renewable sources. There will also be consequent reductions in CO<sub>2</sub> emissions and at lower speeds and light loaded conditions greater fuel savings can be achieved. In port the ship is capable of operating on batteries only with zero ship-produced emissions.

Hybrid propulsion, therefore, permits a further degree of design flexibility to enable a ship to be configured to equitably balance the constraints of economics and the environment by combining different power sources to meet the demands of the operational profile.

## 4. Further propulsion considerations

### THERE ARE THREE CLASSES OF PROPULSOR: FIXED PITCH PROPELLERS; CONTROLLABLE PITCH PROPELLERS AND DUCTED PROPELLERS

There are other options, when fully integrated with the prime mover characteristics, that can enhance ship propulsion efficiency and thereby reduce emissions given the correct circumstances. These include the propulsor type and characteristics; a range of energy-saving devices; hull form design; hull coatings and appendage design and configuration.

#### 4.1 Propulsors

Several propulsor types are available for ship and marine vehicle propulsion. The majority, however, fall into three classes: fixed pitch propellers, which are by far the greater proportion; controllable pitch propellers and ducted propellers, which normally include either a fixed or

controllable pitch propeller. The choice of propeller type should be determined from the ship's operational profile and the desire for optimisation of fuel usage together with any special ship service requirements such as manoeuvring, vibration reduction, noise emissions or shallow water operation.

**Fixed pitch propellers**, Figure 4.1, have traditionally formed the basis of propeller production. This class of propellers embraces those weighing only a few kilograms, normally for use on small power-boats, to those destined, for example, to propel large container ships, sometimes weighing in excess of 130 tonnes. Design philosophies normally focus on propeller efficiency where the open water efficiency ranges from around 50% for large full form tankers and bulk carriers through to 70 or 75% for some finer hull form, faster



Figure 4.1 A cruise ship's starboard fixed pitch propeller  
[Courtesy J.S. Carlton]

vessels. A variant of these propellers is the CLT propeller which attempts to enhance propulsion efficiency by the use of blade end plates.

Irrespective of any intrinsic engine improvements in specific fuel oil consumption, provided there are no restrictions on propeller diameter introduced by the ship's hull or base line clearances, a large diameter, slow turning propeller will normally give the best overall propulsive efficiency for a particular ship design speed. The hull's ability to accept such a propeller, in relation to hull clearances and in providing good inflow into the propeller without creating unduly high pressure impulses on the hull from cavitation growth and collapse on the propeller blades, is a major determinant when designing for efficiency. These latter aspects have been accentuated in recent years by increases in power transmitted per shaft; the tendency today in many ships to locate deckhouses at the aft end of the hull above the propeller; the maximization of the cargo carrying capacity, which imposes constraints on ships' hull lines; ship structural failure and international legislation.

As propeller-specific loading increases, to avoid the unwelcome effects of cavitation the blade area has to increase which frequently has the effect of reducing propeller open water efficiency. Moreover, in recent years there has been a growing awareness of the effects of underwater propeller radiated noise on marine mammals and fish.

For some small, high-speed vessels both the propeller advance and rotational speeds can be high and the propeller immersion low. In these cases it is sometimes not possible to adequately control the effects of cavitation acceptably within the other design constraints and thrust breakdown or serious blade material cavitation erosion may result. To overcome this problem partially or super-cavitating propellers sometimes find application. However, with these propellers there can be an efficiency penalty since the blade section forms are no longer minimised for drag but are designed to attenuate the worst consequences of the cavitation environment. For even more onerous propulsion conditions surface piercing propellers may be deployed which provide a means of maintaining a reasonable propulsion efficiency. This again underlines

#### CAVITATION

The underlying physical process which produces cavitation, at a generalised level, can be considered as an extension of the well-known situation in which a kettle of water will boil at a lower temperature when taken to the top of a mountain. In the case of propeller cavitation, if the pressure over the blade surfaces falls to a too low a level during one revolution then cavitation will form at sea water temperature. When the cavitation collapses, often very rapidly, at some later point in the revolution then radiated pressures result which may cause unacceptable ship structural vibration and noise some distance from the ship. Moreover, if sufficient energy transfer takes place during the cavitation collapse process then erosion of the blade material may occur. Depending on the energies involved this may either give rise to erosion which fully penetrates the blade in a short time or may simply roughen the material surface. Even in this latter case this may be sufficient to increase the propeller blade drag.

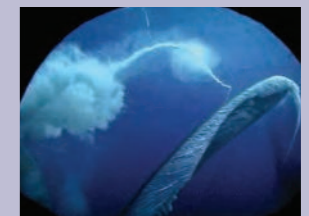

Cavitation on a LNG ship's propeller

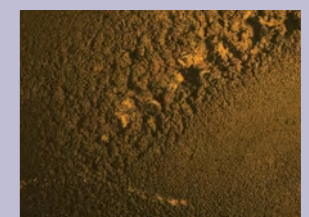

Cavitation induced material erosion

the need for a ship engineering systems approach to the ship design problem: particularly in achieving the appropriate combination of power absorption, shaft rotational speed, ship speed and inflow to the propeller together with adequate hull clearances and static pressure.

**Controllable pitch propellers** provide, unlike fixed pitch propellers whose only operational variable is rotational speed, an extra degree of freedom because in addition to possible rotational speed changes the blades have the ability to change blade pitch; Figure 4.2. Nevertheless, for some propulsion applications, particularly those involving shaft-driven generators, it may be desirable from an overall efficiency point of view for the shaft speed to be held constant and vary the power absorption by adjusting the blade pitch: thereby, reducing the number of propeller operating variables to one. While this latter arrangement can be helpful for overall energy efficiency, it may introduce additional cavitation difficulties.

Where two or more design operating points are required for the ship, controllable pitch propellers may provide a better solution in terms of efficiency by accepting some efficiency penalty in particular operation conditions in order to achieve a higher

overall efficiency over the entire operational profile. Apart from providing a means of enhancing overall efficiency in this way, the controllable pitch propeller has advantages in ship manoeuvring or dynamic positioning situations. While for most seagoing ships fixed and controllable pitch propellers provide acceptably efficient propulsion solutions, a further propulsor variant is the ducted propeller.

**Ducted propellers** comprise two principal components: an annular duct surrounding a propeller which operates inside the duct. These propulsors have found extensive application where high thrust at low speed is required; typically in anchor handling, towing and trawling situations when the duct contributes some 40 to 50% of the propulsor's total thrust at or near zero ship speed. Ducts, in addition to being fixed structures rigidly attached to the hull as seen in the Figure, are in some cases designed to be steerable which then obviates the need for a rudder since the thrust can then be vectored by the azimuthing duct.

As an alternative to steerable ducted propellers there are either non-ducted or ducted azimuthing propulsors where both propeller and duct, if fitted, are



Figure 4.2 Controllable pitch propeller testing. This photograph is reproduced with the permission of Rolls-Royce plc, © Rolls-Royce plc 2013



Figure 4.3 A contra-rotating propeller system incorporating a podded propulsor [Courtesy ABB]

trainable about a common pod strut.

**Azimuthing thrusters** have been in common use for many years for dynamic positioning and situations where high levels of manoeuvrability are needed. The essential difference between azimuthing propellers and a further variant, the **podded propulsor**, is where the engine or motor driving the propeller is sited: if the engine or motor driving the propeller is sited in the ship's hull then the system is termed an azimuthing propulsor and most commonly the mechanical drive would be of a Z or L type to the propeller shaft. In the case of a podded propulsor, the drive system comprises an electric motor directly coupled to a propeller shaft, supported on a system of bearings, in the pod. The propellers associated with these latter propulsors have been of the fixed pitch, non-ducted type, whereas azimuthing units have either fixed or controllable pitch propellers. Currently, the largest size of podded propulsor unit is around 23 MW and their use has been mainly in the context of cruise ships and ice breakers, where their manoeuvring potential is fully exploited.

The **contra-rotating propeller** principle, comprising two coaxial propellers sited one behind the other and rotating in opposite directions, has the hydrodynamic advantage of recovering part of the slipstream rotational energy which would otherwise be lost in a conventional single

propeller configuration. Contra-rotating propellers have been of considerable theoretical and experimental interest as well as having been the subject of some full scale development exercises. While they have found significant application in small high-speed outboard units, the mechanical problems associated with two long shafts rotating co-axially in opposite directions have generally precluded them from wider use. Interest in the concept has been cyclic, however, an upsurge in interest in 1988 resulted in a system being fitted to a 37,000 dwt bulk carrier and subsequently to a 258,000 dwt VLCC in 1993. More recently a variant of the original contra-rotating concept has been proposed and fitted to some ships. This comprises the combination of a traditional propeller, driven from a conventional line shaft, as the forward member of the pair with a podded propulsor acting as the astern component: Figure 4.3. Furthermore, such an arrangement has the potential benefit of removing the need for a rudder since the azimuthing podded propulsor provides the steerage capability for the ship.

**Cycloidal propeller** development started in the 1920s, initially with the Kirsten-Boeing and subsequently the Voith-Schneider designs. They comprise a set of vertically mounted vanes, six or eight in number, which rotate on a disc mounted in a horizontal or near horizontal plane. The



Figure 4.4 Typical fast ferry application of waterjet propulsion

vaned are constrained to move about their spindle axis relative to the rotating disc in a predetermined way by a governing linkage. While having comparatively low efficiency, vertical axis propellers have significant advantages when manoeuvrability or station keeping is a high ship operational priority since the resultant thrust can be varied and readily directed along any navigational bearing.

**Waterjet propulsion** has found application on a variety of small high-speed craft and ferries while its application to larger craft is growing with tunnel diameters of upwards of 2 m. Waterjets, Figure 4.4, potentially offer a relatively efficient solution in difficult hydrodynamic situations for conventional propellers together with very good manoeuvrability.

**Magnetohydrodynamic propulsion** can provide a means of ship propulsion without the need for propellers or paddles. It is based on the Lorentz force equation derived in the 19th century. The idea of electromagnetic thrusters was first patented in the USA in 1961 (Rice 1961). In the early 1990's Mitsubishi Heavy Industries built the MHD powered demonstration ship

*Yamato 1*. This 150-tonne craft used liquid helium-cooled superconducting magnets to achieve the required high magnetic fields; however, the achieved speed was around 8 knots.

An anticipated benefit of MHD drives was that they were expected to be near silent in operation and hence became of considerable interest to the submarine community. However, in practice this proved not to be the case. The production of bubbles at the electrodes creates broadband noise emissions that span a frequency range from 2kHz to 20 kHz and beyond, but with most of the energy in the range 2kHz to 6kHz. This noise is created principally through coalescence of bubbles having diameters between 0.075mm and 0.15mm which become spherical as they move away from the walls of the duct and hence become effective omnidirectional acoustic sources. Although MHD principles have been used successfully in electromagnetic rail guns and in liquid metal pumps, they have proved less successful for marine propulsion.

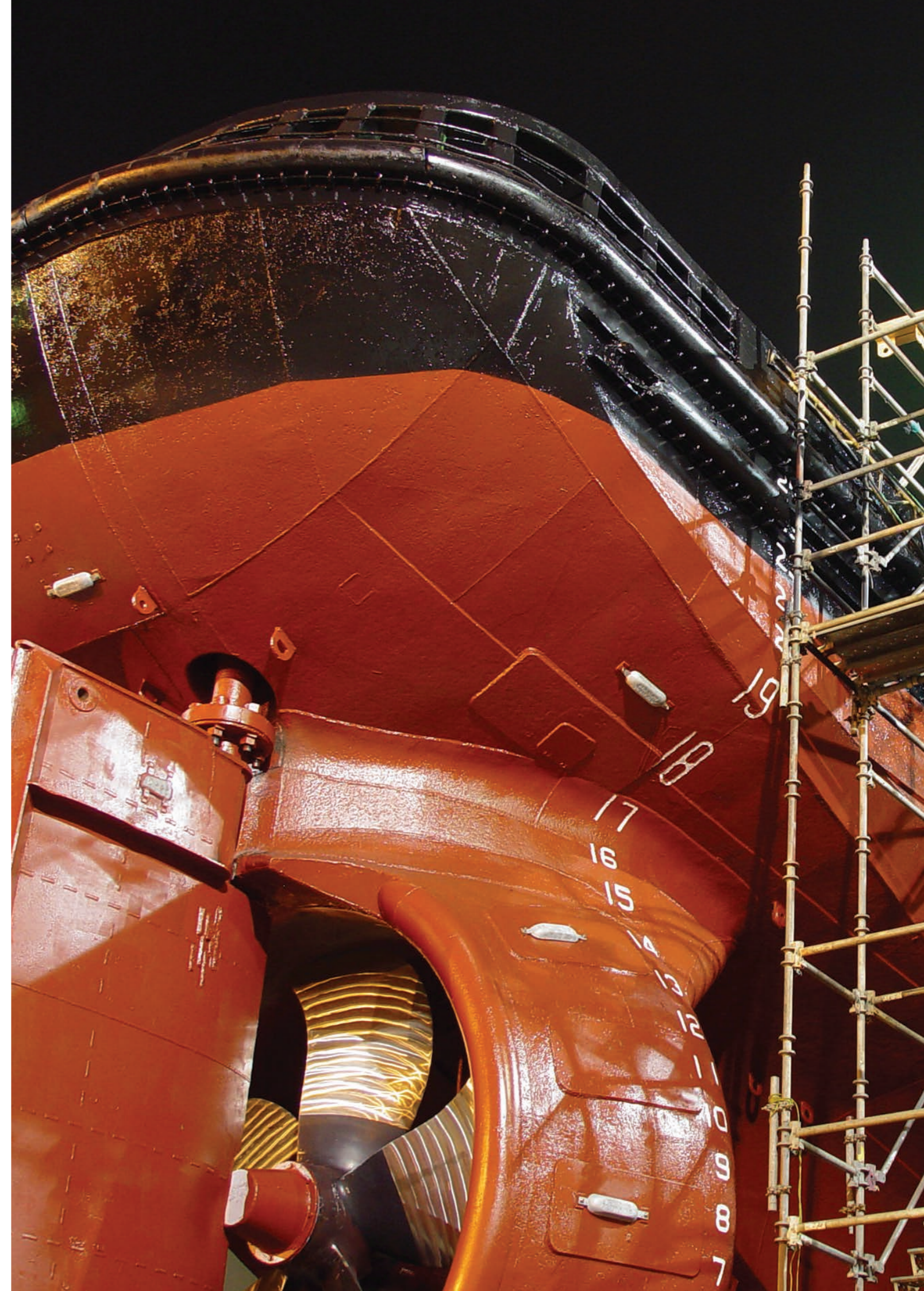

## 4.2 Energy-saving devices

Energy-saving devices based on hydrodynamic interaction can be considered as operating in three basic zones of the hull: before the propeller; at the propeller station and after the propeller. However, some devices overlap these somewhat artificial boundaries. Those acting just ahead of the propeller are interacting with the final stages of the ship's boundary layer growth. This is to gain some direct flow-related benefit or present the propeller with a more advantageous flow regime in which to operate: in some cases both. Devices at the propeller station and downstream are operating within both the hull wake field and its modification by the slipstream of the propeller. In this way they are attempting to recover energy which would otherwise be lost.

Table 4.1 includes some of the more common flow augmentation devices most of which aim to achieve propulsive

efficiency enhancements in specific ship applications. The devices are directed towards different ship types and flow configurations and have some merit in their particular areas of application. However, due to the complexities of the flow in the ship's afterbody region, many require a combination of model testing, computational fluid dynamic and classical analysis to optimize their performance. It has to be realised that if some devices are used outside of their intended fields of application, disappointing results can occur. As such, care in application is essential.

It is also pertinent to consider whether the various energy-saving devices are compatible with each other so as to enable a cumulative benefit to be gained from fitting several devices to a ship. In general this is not the case because some devices remove or alter the flow regimes upon which others depend. However, if devices depend on different regions of the flow field around the ship and are mutually independent, it can be possible to deploy them in combination in order to gain an enhanced benefit.

Energy saving and flow conditioning device	Operation
Wake equalizing duct	Devices which operated on the flow before the propeller.
Asymmetric stern	
Grothuis spoilers	
Semi or partial stern tunnels	
Mewis ducts	
Reaction fins	
Mitsui integrated ducted propellers	
Hitachi Zozen nozzle	Operation at the propeller
Increased diameter/low rpm propellers	
Propellers with end plates	
Keppel propellers	
Propeller boss cap fins	Devices operating just behind or at the propeller
Grim vane wheels	
Additional rudder thrusting fins	
Rudder bulb fins	

Table 4.1 Energy saving and flow conditioning devices [Carlton, 2012]

### MAGNETOHYDRODYNAMIC PROPULSION

The Lorentz force equation can be written as

$$\mathbf{F} = e[\mathbf{J} + (\mathbf{v} \times \mathbf{B})]$$

where  $\mathbf{J}$ ,  $\mathbf{B}$  and  $\mathbf{v}$  are vectors defining, respectively, electric and magnetic fields and the velocity  $\mathbf{v}$  of the charge carriers. It states that a force  $\mathbf{F}$  is experienced by a charge of magnitude  $e$  equal to the vector sum of that due to the electric field,  $e\mathbf{J}$ , and that due to the motion of the charge through any additional magnetic field,  $e(\mathbf{v} \times \mathbf{B})$ . Here  $\mathbf{v} \times \mathbf{B}$  is the vector cross product of  $\mathbf{v}$  and  $\mathbf{B}$  and creates a force vector normal to the plane containing vectors  $\mathbf{v}$  and  $\mathbf{B}$ . In its simplest configuration, the electric and magnetic fields are arranged orthogonal to each other with the normal to their plane pointing in the direction of the desired thrust. The electric field  $\mathbf{J}$  leads to the transport of charge across the duct and hence creates the velocity field  $\mathbf{v}$  necessary to produce the axial thrust from the cross product of  $\mathbf{v}$  and  $\mathbf{B}$ .

Internal duct flow

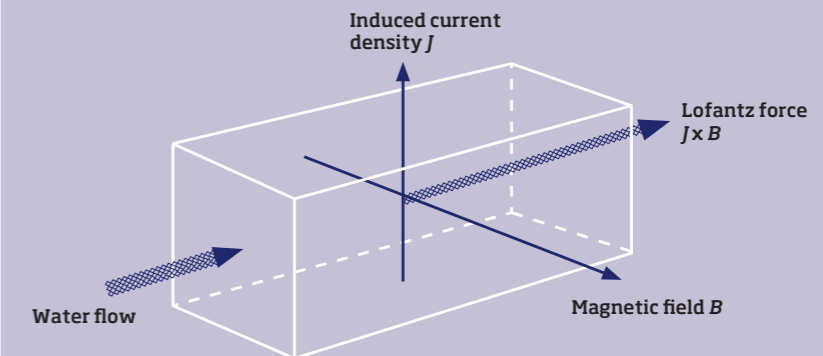

Magneto-hydrodynamic operation principle

The thrust of an MHD drive is proportional to  $\sigma B^2$  where  $\sigma$  is the conductivity of the liquid being pumped; in the case of a ship this being sea water. The necessary magnetic fields can be large even by modern standards. For torpedoes with a high top speed it may be necessary to create fields in the range 15T to 20T, however, for ships and submarines at typical speeds the magnetic field can be lower, around 5T to 10T. This, however, raises serious concerns around magnetic stealth in relation to warships.

The electric field has certain detrimental consequences. Unlike fresh water, in which hydrogen appears at the cathode and oxygen at the anode, in seawater trace elements which typically are ions of sodium, chlorine, magnesium, sulphur, potassium and calcium give rise, in addition to oxygen, to the production of other chemical species and to chlorine gas at the anode. The high pH at the cathode leads to scale production, typically of calcium hydroxide or magnesium hydroxide, which are electrically insulating. Consequently, over a period of a few days the current can reduce by 12% and with it the effectiveness of the drive. Where copper or aluminium anodes have been used, these can be severely corroded as  $\text{CuO}_2$ ,  $\text{AlO}_2$ , or their chlorides are produced and hence careful selection of electrode material is necessary. The electrolysis process produces gases at the electrodes and these have the effect of blanketing the electrodes and hence the cathode is best placed at the bottom of the duct to encourage hydrogen to rise into the induced flow and be swept out of the duct.



## WITHIN THE SHIP DESIGN PROCESS IT IS IMPORTANT TO CONSIDER ALTERNATIVE DESIGN SOLUTIONS AND NOT SIMPLY FOLLOW ACCEPTED WISDOM

### 4.3 Hull design and appendages

A ship's propulsive efficiency comprises three components: propulsor open water efficiency, hull efficiency and the relative rotative efficiency. The latter component is small since it is the ratio of the torque absorbed by a propeller in open water to that when working in the wake field behind the ship. In general, the first two components are dominant and propeller open water efficiency is generally considered in Section 4.1.

The hull efficiency is governed by the hull form and its principal dimensions. These are subject to a number of constraints in addition to those imposed by the principles of ship hydrodynamics. For example, ship length may be a commercial function of nominal berth length; hull draught restrictions due to port water depths; breadth by safe navigation in channels or through locks and in the case of container ships, the outreach of the dockside cranes. Additionally, there may be constraints imposed by the building dock. These and other similar factors have to be recognised but, nevertheless, challenged for validity in an attempt to achieve the most hydrodynamically efficient hull form. If this design optimisation is not done effectively the ship will inevitably carry an efficiency penalty by not being correctly optimised.

Once valid design constraints have been established the hull form can be effectively designed: a process which is based on the

necessary compromises that have to be made between resistance and propulsion, stability, seakeeping and manoeuvrability in order to meet the desired operational profile. During this process, it is essential to recognise that the propulsor has to operate within the flow field generated by the hull and by not taking due recognition of this, hull design decisions may be taken which ultimately inhibit the propulsor design from attaining the best efficiency. This underlines the need for a holistic systems approach to ship hydrodynamic design.

Within the design process it is important to consider alternative design solutions and not simply follow 'accepted wisdom'. An example of this is to be found in recent research into tanker design where convention might dictate a hull block coefficient in the region of 0.82 for a 250m long ship. However, model tests have suggested that a solution which relaxes the length constraint slightly and in conjunction with a block coefficient of 0.63 enhances the performance in both the ballast and loaded conditions with estimated potential fuel savings of around 8.8 tonnes/day.

### 4.4 Hull coatings

Hull coatings and roughness play an important part in the minimisation of the skin friction component of resistance. This is a significant component of the total resistance as seen from Table 4.2 (Carlton 2012). Hull surface roughness comprises the sum of two elements; permanent roughness

and temporary roughness. The former refers to the amount of unevenness and condition of the hull plating in terms of the bowing of the ship's plates, weld seams and the condition of the steel surface, while the latter principally accounts for fouling and deposits that build up on the hull surface.

Fouling commences with slime, comprising bacteria and diatoms, which then progresses to algae and in turn on to animal foulers such as barnacles, culminating in the climax community. In this cycle (Christie 1981) the colonization by marine bacteria on a non-toxic surface is immediate, their numbers reaching several hundred in a few minutes, several thousand within a few hours and several millions within two to three days. Diatoms tend to appear within the first two or three days and then grow rapidly, reaching peak numbers within the first fortnight. Depending on the prevailing local conditions, this early diatom growth may be overtaken by fouling algae. The mixture of bacteria, diatoms and algae in this early stage of surface colonization is recognized as the primary slime film. The fouling community which will eventually establish itself on the surface is known as the climax community and is particularly dependent on the localized environment. In conditions of good illumination this community may be dominated by green algae, barnacles or mussels.

The tin-based marine coatings, particularly tributyltin (TBT), were excellent in keeping underwater hull surfaces free of fouling and, in so doing, reducing fuel consumption. However, they were exceedingly detrimental to the environment and were eventually banned in 2008 following discussion at IMO MEPC. Currently a number of alternative marine paints have come on to the market such as copper-based and synthetic biocide paints; nevertheless, further work is proceeding to find alternatives. Silicon-based paints have also been marketed

and, while relatively expensive, can be effective in preventing fouling when used in the correct circumstances. Many of these products are under evaluation by shipowners to see how well they satisfy their particular needs: among other factors, these relate to application cost, durability and effectiveness in minimising fuel consumption within the operational spectrum.

Research work is progressing to find ecologically friendly alternatives. One such method is based around electrochemically active coating systems. This concept produces regularly changing pH values on the surface of the hull and thereby effectively prevents fouling colonization without having to use biocides (Fraunhofer 2012). Initial tests have been promising in proving product stability and efficiency in preventing bio-fouling.

Research has been undertaken over many years to endeavour to minimise frictional drag. Methods involving the injection of small quantities of long-chain polymers into the turbulent boundary layer surrounding the hull, such as polyethylene oxide, were shown in the 1960s to significantly reduce resistance, provided the molecular weight and concentration were chosen correctly. Those methods which relied on the injection of chemical substances into the sea along the hull surface are unlikely to be environmentally acceptable today. Nevertheless, current research is focusing on a range of methods involving boundary layer fluid injection and manipulation. These typically embrace the injection of low-pressure air either to develop a micro-bubble interface between the hull and the sea water or through the provision of an air cushion trapped by an especially developed hull form. Further research is exploring the frictional resistance benefits obtainable from the texture of hull coatings and in some cases endeavouring to emulate the skin of marine mammals and fish.

Ship type	Frictional to total resistance ratio
ULCC 516893 dwt (loaded)	0.85
Crude oil tanker 140803 dwt (loaded)	0.78
(ballast)	0.63
Products tanker 50801 dwt (loaded)	0.67
Container ship 37000 dwt	0.62
Cruise ship	0.66
Ro/Ro ferry	0.55

Table 4.2 Comparative importance of frictional resistance with respect to ship type

## HIGH TEMPERATURE SUPERCONDUCTORS WERE DISCOVERED IN 1986, BUT THEIR PRODUCTION AS USEFUL CONDUCTORS IS STILL NOT FULLY INDUSTRIALISED

### 4.5 Superconducting electric motors

Although large conventional electric motors are efficient, superconducting motors can be more efficient, around 99% – especially when running at less than their maximum speed. This improvement can lead to savings in fuel and gaseous emissions. Moreover, superconducting motors are smaller and more power-dense than conventional motors of similar power; typically around 30 kW/kg compared to about 5 kW/kg for a conventional motor. Additionally, high-temperature superconducting motors have signature benefits that are attractive in naval service.

In January 2009, the American Superconductor Corporation (AMSC), together with the Northrop Grumman Corporation, announced the successful completion of the full-power land-based testing of a 36.5 MW high temperature superconductor ship propulsion motor, (Figure 4.5). However, there are currently no superconducting motors in use on ships.

High-temperature superconductors were discovered in 1986, but their production as useful conductors is still not fully industrialised: they are expensive and difficult to make and require particular grain alignments. Although a new simpler superconductor material, magnesium diboride, was discovered in 2001, its lower critical temperature and sensitivity to magnetic fields mean that its applicability to rotating machinery is still a matter of research.

Despite being discovered over 100 years ago, superconductivity remains an active area of fundamental research. However, it is not unreasonable to expect that superconducting motors operating at commercially accessible cryogenic temperatures, and constructed using an affordable wire, will become available in the next decade or two. However, it takes a significant time for a totally new superconducting material to become available as a useful engineering wire, and most superconducting materials are inherently unsuitable for this engineering application. The design of superconducting rotating machinery is itself also an active research area, so commercial availability of this technology must be viewed in the medium to long term.

#### Some potential advantages and disadvantages of the technology:

##### Advantages

- The technology has been shown to be viable in large demonstrator applications.
- Losses in the electrical machine are low resulting in a more efficient motor.
- Exhaust emissions can be lower.
- The size and weight of the electrical machine is lower.

##### Disadvantages

- A cryogenic cooling system has to be provided for the current and expected future generations of machines and continued operation of the motor will be dependent on the reliability of the cooling system.
- The technology has yet to be proven at sea.

## DESPITE BEING DISCOVERED OVER 100 YEARS AGO, SUPERCONDUCTIVITY REMAINS AN ACTIVE AREA OF FUNDAMENTAL RESEARCH

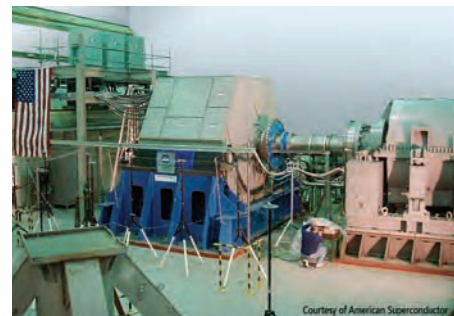
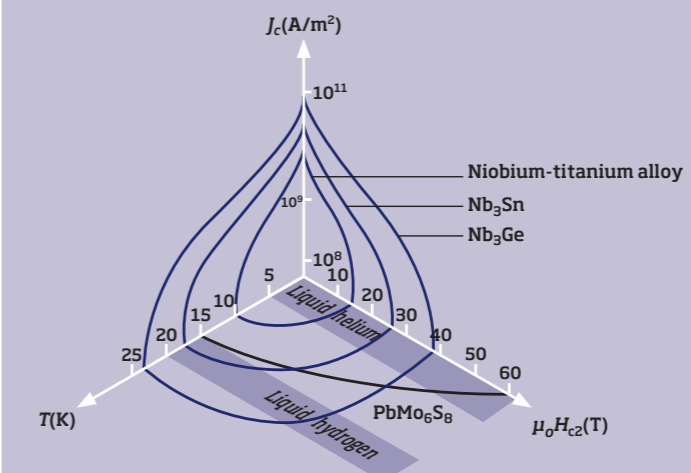

Figure 4.5 Superconductor motors and generators are significantly smaller and lighter than conventional rotating machines. This photo shows a 36.5 megawatt superconductor ship propulsion motor that was designed and manufactured by AMSC for the U.S. Navy. This machine, which successfully passed land-based testing, was less than half the size and weight of a conventional motor of the same power rating. Photo courtesy of AMSC

The discovery of superconductivity, in 1911, is credited to Heike Kamerlingh-Onnes. He spent his career exploring extremely cold refrigeration techniques and, in 1908, was the first to liquefy helium which he used to study platinum and gold at very low temperatures – but without detecting what would become known as superconductivity. He then turned to mercury and at about 4.2°K the resistance of his mercury sample dropped from 0.11Ω to less than 10<sup>-5</sup>Ω. This sudden and significant drop in resistance is a signature of superconductivity and the temperature at which it occurs is the critical temperature. Shortly afterwards superconductivity was also discovered in tin and lead and in 1913 Onnes was awarded the Nobel Prize for the discovery of superconductivity.

In 1933, Meissner and Ochsenfeld reported that magnetic fields are expelled from superconductors. The appearance of a critical temperature and the Meissner effect are taken as the defining evidence that a substance is in a superconducting state.

All superconductors are characterised by three parameters: a critical temperature; a critical magnetic field strength; and a critical current density. If any of these are transiently exceeded the material will suddenly return to the normal non-superconducting state and possibly serious damage can occur. Critical currents and fields depend upon temperature and both, in general, decrease smoothly to zero as temperature increases to the critical temperature, as shown in the Figure.



Typical current, field and temperature dependencies of superconductivity.

High temperature superconductivity was first reported in a paper published in April 1986. This paper by Bednorz and Muller described an insulating barium-lanthanum-copper-oxygen ceramic compound with a previously unheard-of critical temperature of 30°K. In less than a year of their publication a second compound, this time of yttrium-barium-copper-oxygen (YBCO), was identified with a transition temperature of ~96°K. In 1987, Bednorz and Alexander received the Nobel Prize for their work and an urgent search started for additional high-temperature superconductors. At the present time, many high-temperature superconductors with critical temperatures above 96°K have been identified, and many more completely new classes of superconducting materials have been discovered. Nevertheless, the current front-runner for most engineering applications involving magnetic fields is YBCO, discovered in 1987, but it has taken more than 20 years to develop effective engineering conductors using it. One difficulty is that the grain alignment required means that the conductors are flat tapes, not round wires, which makes winding coils more complicated and limits the design of coils and hence the machines that can be built using them.

## 4.6 Ship operational considerations

### 4.6.1 Operational profile

The intended operational profile of a ship, in terms of the proportion of time likely to be spent at particular speeds, is a fundamental parameter in forming the design basis of a ship and its propulsion machinery. From the operational profile the choice of machinery type and arrangement will be made as well as the propeller type and its design point(s). These parameters, together with the hull form, are fundamental to the determination of the basic overall efficiency of the ship.

### 4.6.2 Weather routing

The underlying purpose of weather routing is to establish the optimum track for long distance voyages, since, in the presence of adverse weather, the shortest route is not always the fastest or the most economic. This is because, notwithstanding the potential for causing damage (Section 2.3), maintaining speed in storms or poor weather causes added resistance due to the wind and waves, the magnitude of which is dependent on the severity and direction of the weather relative to the ship. This increases fuel consumption. Alternatively, if speed is reduced through adverse conditions, estimated times of arrival can be extended with consequent implications for docking slot availability. The principal idea, therefore, is to use updated weather forecast data and choose an optimal route through calmer sea areas or areas that have the most downwind tracks based on predictive and optimisation methodologies. Such approaches rely on a knowledge of the ship's calm water resistance and added resistance in waves. These systems have been deployed in various forms of complexity over the last thirty or so years to good effect. However, the increasing sophistication of weather forecasting over that period has permitted a continuing enhancement of the technique.

The more advanced systems take into account the ocean currents, wave and swell composition and wind speeds in their optimisation of the voyage parameters. The resulting track information can then be imported to the ship's navigation system. In this way, on board monitoring and decision support systems can be deployed and an energy-efficient approach to ship operation implemented. Indeed, when arrival times are critical these approaches to voyage planning help to mitigate the effects of the approach common some years ago of steaming at full speed on departure for a day or so 'to get some time in hand' against any adverse conditions that might subsequently be encountered during the voyage. Recognising the approximately cubic relationship of power with ship speed, this is seen as a very expensive practice, both economically and environmentally.

### 4.6.3 Plant operational practices

The condition of the ship's machinery has an important influence on the economic performance of the ship. Condition monitoring, performance measurement and maintenance practices are therefore a critical component in keeping the plant in optimal condition. Furthermore, unmotivated crews, for whatever reason, are unlikely to maintain a ship at its peak performance. Alternatively, a poorly designed machinery space with limited access problems to components can also be a disincentive to conduct proper maintenance activities.

Notwithstanding the influence of poor weather on fuel consumption, in a recent study centred on a ferry sailing between Stockholm and Helsinki some 7% less fuel consumption was achieved by optimising the ship's speed during the passage in conjunction with crew training. These savings were achieved using real-time decision support systems to advise the crew about ship operation, route planning and navigation with the goal of optimising energy use and maintaining emissions to



a minimum level. These types of capability have been under development since the mid-1970s, and with progressive increases in instrumentation and predictive capabilities have become increasingly more powerful. There is nevertheless still scope for the development of these methods.

In addition to decision support methods, there is the ability to sail the ship at slower speeds with the attendant advantage of reductions in fuel consumed. This carries the implication of longer voyage times as well as for the accountancy notion of the cost of goods in transit, but in addition to the fuel savings it also has beneficial

environmental consequences. Slower ship speeds can be prescribed for the initial design or as an imposition on an already faster design of ship, given that the main engine's slow running constraints are satisfied. In this latter case the propeller may also be modified or redesigned to further enhance the propulsive efficiency of the ship because of the lower specific thrust loading; Section 4.1. The dangers of under-powering a ship, discussed in Section 2, must also be recognised if potentially hazardous situations are to be avoided.

IN THE PRESENCE OF ADVERSE WEATHER, THE SHORTEST ROUTE IS NOT ALWAYS THE FASTEST OR THE MOST ECONOMIC

# 5. Time frame for technical development

A range of ship propulsion options have been considered. While some are applicable in the short term, others are medium- and long-term options, due to the necessary technical, commercial and political developments. Some are unlikely to come to fruition within a reasonable timescale.

Figure 5.1 develops a perspective on the likely progress towards maturity of the propulsion methodologies as seen currently from the technical and research funding

perspectives within the marine and related industries. The actual progress will be dependent on the pace of technological development, commercial motivation, public perception and political acceptability.

Appendix 10 considers the applicability of the various options discussed in this report to a range of ship types. Within these ship types, both new and existing ships are considered as well as operational practice.

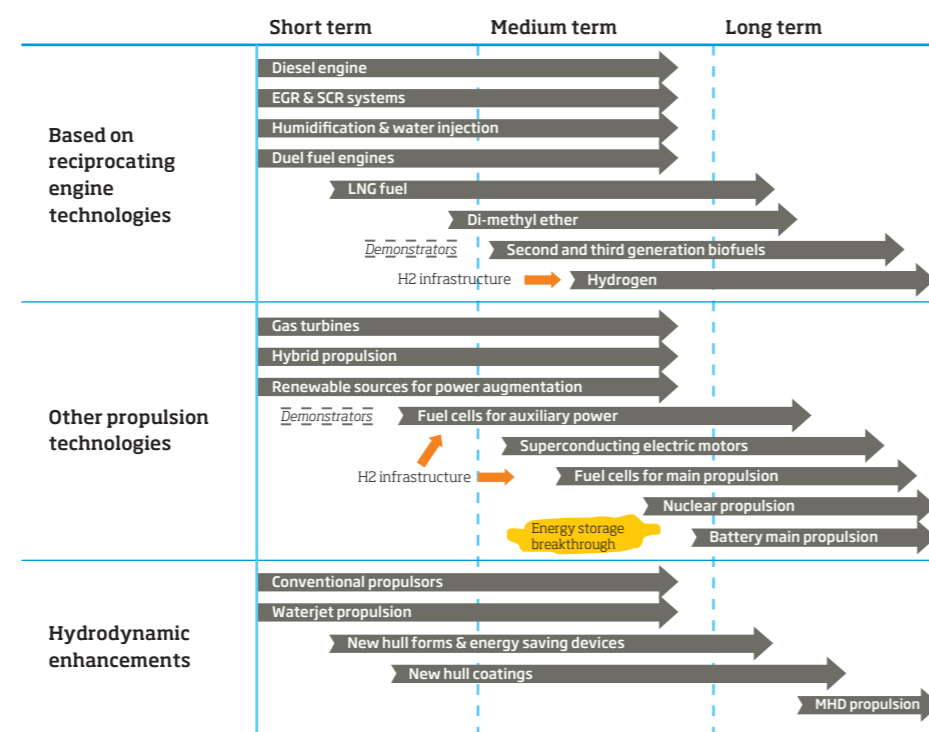

Figure 5.1 Potential phasing of different propulsion technologies in time



## 6. Conclusions

### THE CONDITION OF A SHIP'S MACHINERY HAS A SIGNIFICANT INFLUENCE ON FUEL CONSUMPTION AND EMISSIONS PERFORMANCE

It is evident that to optimise the potential benefits of a propulsion option, or combination of options, in terms of efficiency and minimising the impact on the environment, an integrated ship design procedure based on a systems engineering approach must be employed. Fundamental to this process is the proper definition of the intended ship's operational profile and the perceived tolerance on this profile to meet future market fluctuations. When this profile is combined with the anticipated future daily fluctuations in the ship operating and fuel costs, a design space can be defined within which the ship system can be contemplated. Furthermore, anticipated changes in environmental or legal frameworks should be introduced into this design space definition.

Within a ship system design approach, consideration must be given to the integration of the various subsystems and their relative influences upon each other. This should include the prime mover or fundamental power source; fuel characteristics; the hull form together with the challenging of any constraints imposed upon it; the propulsor type and the creation of conditions to achieve the maximum efficiency possible; the minimisation of appendage resistance and the inclusion of other appropriate energy-saving devices. Furthermore, hull coatings are an essential engineering consideration in achieving optimal powering, since for many ships the frictional resistance is a significant proportion of the total ship resistance.

With regard to ship operation, it has been demonstrated that weather routing of ships between ports to avoid poor weather and storms, with the consequent influence on a ship's added resistance, has important fuel consumption benefits. Similar benefits are also realisable when ship speed is optimised during voyages as well as investing in appropriate crew training so they fully understand the implications of actions they may take. In this context, real-time decision support systems with the goal of optimising energy use and minimising emissions are helpful in achieving these fuel savings.

There is the ability to invoke slower ship speeds since this will result in reductions in fuel consumed and have beneficial environmental consequences. These slower speeds can be prescribed for the initial design or as an imposition on an already faster design of ship; given that the limitations arising from the main engine's slow steaming constraints are satisfied. In this latter case further performance benefits can be gained from redesigning or modifying the propeller to accommodate the resulting lower specific thrust loading. Notwithstanding any benefits derived from slow steaming, there is an operational risk in fitting ships with too small engines, to meet environmental design indices or other criteria, as the ships may have insufficient power to navigate safely in poor weather.

The condition of a ship's machinery has a significant influence on fuel consumption and emissions performance. There is

therefore good reason to keep machinery well-maintained, particularly in view of the increasing levels of complexity. In this respect, demotivated crews, for whatever reason, are unlikely to maintain the ship at its peak performance: conversely, a poorly designed machinery space which has accessibility problems will militate against proper maintenance activities, however well the crew are motivated.

The hull and machinery insurance impact of most of the systems considered in this report, with the exception of nuclear propulsion, is likely to be relatively low. Indeed, they are unlikely to merit specific consideration beyond insurers understanding any new technology and the costs associated with repairs. A caveat to that, however, could be the market's previous experience with new systems which may encourage underwriters to impose higher policy deductibles or self insured retentions. Cover might be modified, or the insured forced to run a higher self-insured retention, in cases of truly prototypical technology. This is because the fear of costly repairs and the prototypical nature of a system may prompt hull and machinery underwriters to restrict cover in some way and to charge higher premiums to reflect any new technology. Nevertheless, the transfer of a land-based technology together with that experience to a marine environment may help in that respect.

The adoption of alternative propulsion options will be dependent on the price of fuels, the impact of present and future environmental legislation and the likelihood of carbon tax introduction. In the case of fuel price, recent experience has demonstrated a trend towards increase superimposed with strong fluctuations. However, there is debate whether the presently observed trends will be carried forward into the future. Set against this background the propulsion options in the short-, medium- and long-term time frames can be considered.

#### Short-term options:

In the short term, the diesel engine is currently the most widespread marine prime mover for ship propulsion. Moreover, diesel engine technology is a well-understood and reliable form of propulsion and auxiliary power generation technology and engine manufacturers have well-established repair and spare part networks around the world. There is also a supply of trained engineers and their training requirements are well known and established facilities exist for the appropriate levels of training. In the immediate future methods for reducing emission levels exist and there are continuing programmes of research and development being undertaken by the engine builders. At present engine builders are generally confident of meeting MARPOL Annex VI Tier 3 requirements by combinations of primary and secondary methods. Furthermore, all grades of fuel have a worldwide distribution network and are readily obtainable. However, there is now some contamination of the marine fuel supply by first-generation biofuels and this needs to be carefully managed on board ships. Nevertheless, diesel engines produce CO<sub>2</sub> emissions as well as NO<sub>x</sub> and SO<sub>x</sub>, volatile organic compounds and particulate matter, albeit through reduction measures in reduced quantities. It should, however, be noted that the quantity of SO<sub>x</sub> produced is a direct function of the amount of sulphur present in the fuel burnt.

Natural gas is a fuel that can be used in reciprocating engines and is a known technology. Service experience with dual-fuel and converted diesel engines, albeit limited at the present time, has been satisfactory. Indeed, it is relatively easy to convert many existing marine engines to burn LNG and currently this fuel is considerably cheaper than the conventional fuels. LNG fuel, while not free of harmful emissions, has benefits in terms of CO<sub>2</sub>, NO<sub>x</sub> and SO<sub>x</sub> emissions given that methane slip is avoided during the bunkering and combustion processes. In the worldwide context, there is a general lack of a bunkering infrastructure at

## GAS TURBINES HAVE SUCCESSFULLY BEEN USED IN NICHE AREAS OF THE MARINE MARKET AND REPRESENT A PROVEN HIGH POWER DENSITY PROPULSION TECHNOLOGY

present, although LNG has been used to good effect in certain short sea and coastal trades. Additionally, there are now moves to establish larger bunkering facilities at major international ports and some large commercial ships are currently in service or on order to utilise LNG fuel.

Gas turbines have successfully been used in niche areas of the marine market and represent a proven high power density propulsion technology. In particular, their low weight gives considerable flexibility when locating them in a ship in the context of turbo-electric designs. However, the high distillate grades of fuel for aero-derivative gas turbines are expensive when compared to conventional marine fuels and their thermal efficiencies are lower than for slow speed diesel engines of similar power. These can be enhanced, however, in combined cycle installations where the exhaust heat is used to develop additional power.

Renewable energy sources are free from exhaust pollutants. However, wind-based solutions tend to be limited to propulsion augmentation roles unless a full return to sail is contemplated in specific applications. Wind power systems rely on the wind strength to be effective and the use of some systems are dependant upon adequate control system technology being installed on board the ship. Solar energy is feasible as a source of auxiliary power but photovoltaic processes inherently have low effectiveness and require a significant deck area upon which to place an array of cells. Although solar-derived power is global position and weather dependent, it has been demonstrated to augment auxiliary power.

### Medium- to long-term options

Biofuels are a potential medium-term alternative to conventional fuels for diesel engines, although with the first generation of biofuels, biodiesel and bioethanol, some issues have been experienced when used in marine engines. For the future, synthetic fuels based on branch-chain higher alcohols and new types of microorganisms and algae are a medium- to long-term possibilities given that production volumes can satisfy the demand from the marine and other markets. It will, however, be necessary to examine in greater detail aspects of the storage, fuel handling, and impacts on health, safety and the environment. Di-methyl ether also shows potential as an alternative fuel, but at present there are disadvantages which require resolution in terms of lubricity and corrosion together with creating a sufficient production and supply capability.

Fuel cells offer potential for ship propulsion, and at the present time, encouraging experience has been acquired with auxiliary and low-power propulsion machinery. For marine propulsion, the high-temperature solid oxide and molten carbonate fuel cells show most promise, while for lower powers the low-temperature proton exchange membrane fuel cells are more suited. Hydrogen is the easiest fuel to use in fuel cells but this would require a worldwide infrastructure to be developed for supply to ships. Methanol is a possible alternative, but the use of more conventional marine fuels would present problems and necessitate complex onboard pre-processing to take place. Since fuel cells produce a DC electrical output, they would be better suited for ships with hybrid or full electric systems.

The propulsion of ships by nuclear power has the advantage during operation of producing no CO<sub>2</sub>, NO<sub>x</sub> and SO<sub>x</sub>, volatile organic and particulate emissions. Additionally, the cost of uranium has been relatively cheap in comparison to conventional marine fuels and the refuelling

## BATTERIES, BY VIRTUE OF THE RAPIDLY DEVELOPING TECHNOLOGY SURROUNDING THEM, OFFER A POTENTIAL SOLUTION FOR SHIP PROPULSION. FULL BATTERY PROPULSION MUST, HOWEVER, AWAIT FURTHER TECHNICAL DEVELOPMENT, AND EVEN THEN IT IS LIKELY TO BE CONFINED TO THE SMALL SHIP MARKET

of nuclear reactors with ready-made elements would be accomplished under term contracts rather than on-the-spot market. Furthermore, a significant body of experience exists in the design and safe operation of shipboard nuclear propulsion plant: particularly in the case of PWR designs. The conventional methods of design, planning, building and operation of merchant ships would, however, need complete overhaul, since for a nuclear propelled ship the process would be driven by a safety case and systems engineering approach. There would, however, be a number of constraints imposed on ship design and operation as well as on the deployment of this technology, all of which would need resolution. These include international nuclear regulation; design execution and planning, operation, training and retention of crews and shore staff, security, public perception, disposal; financing the initial capital cost; the setting up and the maintenance of an infrastructure support system. Insurance is a serious issue for nuclear merchant ships, and while the insurance industry is a service industry, this would need resolution as governments are unlikely to enter this market as they do for naval ships. Within the discussion it has been seen that the concept of small modular marinised reactor plants or molten salt reactors may attenuate many of these difficulties although not dispose of them. As such, it would be prudent to keep a watching brief on the development of these technologies with a view to implementation in the medium to long term.

Superconducting electric motor technology has been shown to be viable in land-based demonstrator applications up to 35MW, and since the electrical losses are low, result in a more efficient motor. Depending upon the type of prime mover deployed, exhaust emissions will therefore be lower and if a coolant failure occurs, the machine can run for some time after the failure. Some advantage might also accrue from the smaller physical size of the electric machine.

Batteries, by virtue of the rapidly developing technology surrounding them, offer a potential solution for ship propulsion. Full battery propulsion must, however, await further technical development, and even then it is likely to be confined to the small ship market. At present the size of the necessary battery pack would preclude their use as the sole means of propulsion in all but the smallest of ships undertaking short sea voyages. Nevertheless, battery-based propulsion would be beneficial from the CO<sub>2</sub>, NO<sub>x</sub>, SO<sub>x</sub>, volatile organic and particulate emissions points of view since none occur during operation. Batteries in conjunction with other modes of propulsion may offer a potential hybrid solution for the propulsion of small- to medium-sized ships.

With regard to hydrogen, compressed air and liquid nitrogen, these are likely to be long-term propulsion options. While the latter two options are energy storage media, hydrogen is a fuel which generates no CO<sub>2</sub> or SO<sub>x</sub> emissions to the atmosphere and could use land-based renewable sources of power for its creation. Hydrogen has a number of safety issues associated with it and has a low energy density but is ideal for use in fuel cells or could be burnt in suitably modified reciprocating engines. To be viable as a marine fuel, it would need a supply infrastructure, and at present it is largely untried in the marine industry for propulsion purposes. Clearly, should a hydrogen economy evolve at some time in the future then it would be a marine fuel option.

In the case of compressed air and liquid nitrogen they would, again, use land-based sources of power for creation and the tank storage technologies are well understood. Nevertheless, the size, pressure rating and cryogenic capabilities, in the case of liquid nitrogen, of the ship storage tanks would determine the amount of energy storage and hence usefulness of the concept. Moreover, there is an attendant blast risk with high-pressure gas tanks should

IF, IN THE FUTURE,  
A HYDROGEN  
ECONOMY IS  
ADOPTED, THEN  
HYDROGEN MAY  
BECOME AN  
ALTERNATIVE  
MARINE FUEL  
OPTION

fracture initiate and, moreover, corrosion can be an issue in salt-laden environments with high-pressure tanks. As with hydrogen, a supply infrastructure and distribution network would need to be developed, recognising that air is part of the natural environment whereas nitrogen has to be made.

Magnetohydrodynamic propulsion is not seen as being viable in anything but the long term for merchant ships.

In the context of the current and future merchant marine fleets it is considered that:

- i. For existing ships reciprocating engines with exhaust gas attenuation technologies are the principal option together with, if so desired, fuels having less CO<sub>2</sub> emission potential. LNG is one such fuel and together with some other future alternatives requires an adequate bunkering infrastructure to be developed, particularly, for deep sea voyages.
- ii. For presently contemplated newbuildings the scenario is broadly similar but with the option to include hybrid propulsion systems depending on the ship size and its intended duty cycle.

- iii. In the case of ships contemplated for the medium to long term, further propulsion options will present themselves including fuel cells, batteries and nuclear. The former methods await technological development but nuclear, while well-understood technically, would require a major change to ship building, owning and operation infrastructure and practices together with a suitable international regulatory structure.

Renewable sources such as wind and solar are augments to power requirements, assuming a return to full sail propulsion is not contemplated. If, in the future, a hydrogen economy is adopted, then hydrogen may become an alternative marine fuel option.

Underpinning these possible alternatives is a need for further soundly based techno-economic studies on target emissions from ships.

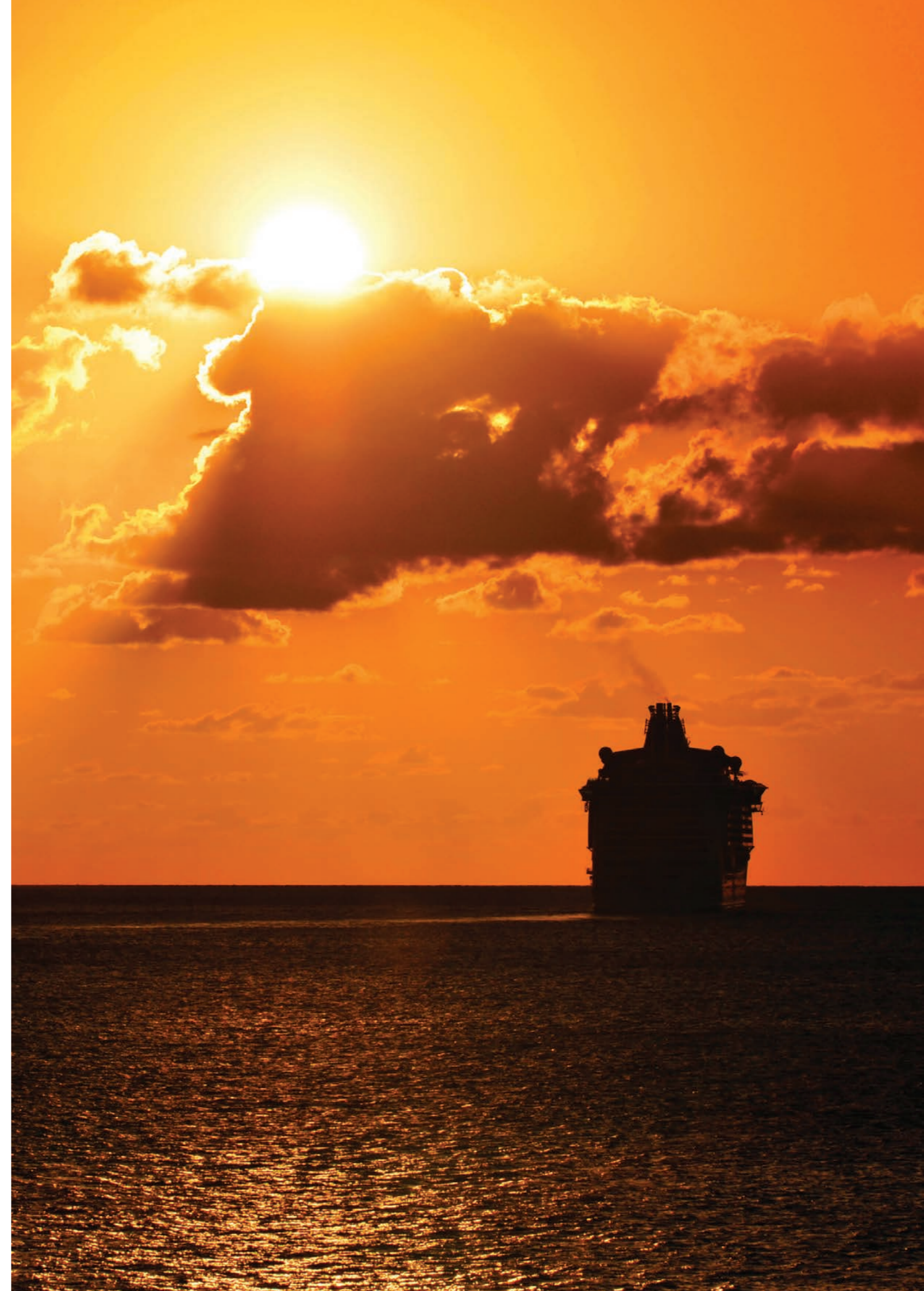

# Glossary of terms

## Acronyms

AIP	Air independent propulsion
AUV	Autonomous underwater vehicle
CIMAC	International Council on Combustion Engines
CMAL	Caledonian Marine Assets Ltd
DC	Direct current
DFDE	Dual fuel diesel-electric [ <i>propulsion systems</i> ]
DME	Di-methyl ether
DNV	Det Norske Veritas
dwt	Deadweight [ <i>of a ship</i> ]
ECA	Emission control area
EEDI	Environmental energy design index
EEOI	Energy efficiency operational index
EGR	Exhaust gas recirculation
EU	European Union
FAME	Fatty acid methyl esters
GT	Gross tonnage
HFO	Heavy fuel oil
IAEA	International Atomic Energy Authority
ICAO	International Civil Aviation Organisation
IEEC	International Energy Efficiency Certificate
IMO	International Maritime Organisation
LNG	Liquid natural gas
LPG	Liquid petroleum gas
MARPOL	Marine Pollution Convention [ <i>IMO</i> ]
MCFC	Molten carbonate fuel cell
MCR	Maximum continuous rating [ <i>of an engine</i> ]
MEPC	Marine Environmental Protection Committee [ <i>IMO</i> ]
MHD	Magnetohydrodynamic
PAFC	Phosphoric acid fuel cell
PEMFC	Proton exchange membrane fuel cell
P&I	Protection and indemnity [ <i>Insurance clubs</i> ]
PM	Particulate matter
PWR	Pressurised water reactor
rms	Royal Mail Steamer
SBI	Subsidiary Body for Implementation
SBSTA	Subsidiary Body for Scientific and Technological Advice
SCR	Selective catalytic reduction
SEEMP	Ship energy efficiency management plan
SMR	Small modular reactor
SOFC	Solid oxide fuel cell
SOLAS	Safety of Life at Sea Convention [ <i>IMO</i> ]
ss	Steam ship
STCW	Standards of Training, Certification and Watch-keeping
teu	Twenty-foot equivalent [ <i>container</i> ] units
US	United States of America
VLCC	Very large crude carrier

## Chemical substances

CH <sub>4</sub>	Methane
CO <sub>2</sub>	Carbon dioxide
H <sub>2</sub>	Hydrogen
H <sub>2</sub> O	Water
NO <sub>x</sub>	Oxides of nitrogen
SO <sub>x</sub>	Oxides of sulphur
Th	Thorium
<sup>235</sup> U	Uranium isotope 235
YBCO	Yttrium-Barium-Copper-Oxide

## Units

bar	bar [ <i>Pressure: 1 bar = 0.9869 Standard Atmospheres</i> ]
C	Centigrade
cSt	centistokes [ <i>Kinematic viscosity: 1cSt = 1m<sup>2</sup>/s</i> ]
h	hour
Hz	Hertz [ <i>Cycles/second</i> ]
J	Joules [ <i>Energy: 1 Joule = 1 Newton.m</i> ]
K	Kelvin [ <i>Absolute temperature: 1 °K = -273.15 °C</i> ]
m	metre [ <i>1m = 1000 mm</i> ]
mm	millimetres
MPa	Megapascals [ <i>1Pa = 1 N/m<sup>2</sup> ⇒ 1MPa = 10<sup>6</sup> N/m<sup>2</sup></i> ]
MWe	Megawatts electrical
N	Newton [ <i>Force: 1 N = 0.10197 kilograms force (kgf)</i> ]
nm	Nautical mile
pH	Logarithmic measure of acidity [ <i>pH=1 Acid; pH=12 Alkali</i> ]
ppm	parts per million
rpm	revolutions per minute
s	second
shp	shaft horse power
V	Volt
W	Watt [ <i>Power: 1W = 1 Joule/second</i> ]

## Common marine terms used in the report

Auxiliary power	Power used for support systems on board and cargo handling.
Bunker fuel	The fuel used for conversion into energy for propulsion or auxiliary purposes.
Bunkering	The process of fuelling a ship.
Deadweight	The difference between the weight of water displaced by the ship and its lightweight .
Displacement	The amount of water displaced by the ship. [ <i>Archimedes' Principle</i> ]
Draught	The distance from the waterline to the lowest point of the keel.
Gross tonnage	Is a measure of the overall size (volume) of a ship, whereas net tonnage is a measure of the useful capacity of a ship. Both are determined by the International Convention on the Tonnage Measurement of Ships.
Lightweight	The weight of the complete ship but with no crew, passengers, baggage, stores, fuel, water or cargo on board.
Trim	The inclination of the ship as measured between the difference in the forward and aft draughts in calm water.

# References

- Andriotis et al. 2008. Andriotis, A., Gravaises, M. and Arcoumanis, C. *Vortex flow and cavitation in diesel injector nozzles*, Journal of Fluid Mechanics, Vol 610, pp195-215, 2008
- Arcoumanis et al. 2008. Arcoumanis, C., Bae, C., Crookes, R. and Kinoshita, E. *The potential of di-methyl ether (DME) as an alternative fuel for compression-ignition engines: A review*. Fuel 87 (2008) pp1014-1030
- BP 2012. *Statistical Review of World Energy 2012*. BP 2012
- Bunkerworld 2012. *Bunkerworld Index*, 22nd October 2012
- Carlton 2012. Carlton, J.S. *Marine Propellers and Propulsion*. Butterworth-Heinemann, 3rd Edition, ISBN 978-0-08-097123-0, 2012
- Christe 1981. Christie, A.O., *Hull roughness and its control*. Marintech Conference, Shanghai, China, 1981
- CIMAC, 2011. Guidelines for Ignition and Combustion Quality, CIMAC, 2011
- Committee on Climate Change 2011. *Review of UK Shipping Emissions*, November 2011.
- Cooper 2012. Cooper, Captain N. *View from the Bridge: The dangers of under powering*. 3rd Ship Propulsion Conference, Trans I.MarEST, London. November 2012
- DfT. UK transport greenhouse gas emissions. Factsheets, DfT
- DNV, 2012. *Fuel cells for ships: Research and Innovation*, Position Paper 13, DNV Oslo, 2012. [http://www.dnv.com/binaries/fuel%20cell%20pospaper%20final\\_tcm4-525872.pdf](http://www.dnv.com/binaries/fuel%20cell%20pospaper%20final_tcm4-525872.pdf)
- Dundee 2007. *The Uranium Sector - Primary Supply Fundamentals: A Re-Examination*. Dundee Securities Corporation, August 30, 2007
- EC 2002-2006. *European Fuel Cell and Hydrogen Projects 2002-2006*. European Commission Brussels. [ftp://ftp.cordis.europa.eu/pub/fp7/energy/docs/hydrogen\\_synopses\\_en.pdf](ftp://ftp.cordis.europa.eu/pub/fp7/energy/docs/hydrogen_synopses_en.pdf)
- Fairplay 2010. *World Fleet Statistics 2010*. IHS Fairplay, Redhill
- Fort 2011. Fort, E. *Sustainable Marine Power - The METHAPU Project*. Proc Lloyd's Register Technology Days, Lloyd's Register, London. 2011
- Fraunhofer 2012. Keeping ship hulls free of marine organisms. Fraunhofer Inst. 2012
- Green Ship of the Future Project, 2012. Klimt-Møllenbach, C. 3rd Ship Propulsion Symposium, Trans IMarEST, London, 2012. [www.greenship.org](http://www.greenship.org)
- Greig 2002. Greig, A. *Fuel cells and issues for their use in warships*. J. Marine Design and Operations, Proc.IMarEST Part B, No3. pp9-20. 2001. ISSN 1476-1556
- Hill et al. 2012. Hill, Sir R., Hodge, C.G. and Gibbs, T. *The potential of the molten salt reactor for warship propulsion*. Trans INEC, IMarEST, Edinburgh, 2012
- IDTechEx 2011. Advanced Energy Storage Technologies: Patent Trends and Company Positioning. <http://www.idtechex.com/research/reports/advanced-energy-storage-technologies-patent-trends-and-company-positioning-000271.asp>
- IEEE. <http://spectrum.ieee.org/energywise/green-tech/advanced-cars/world-lithium-reserves-and-exports>
- IPCC (1995). Working Group I: The Science of Climate Change. IPCC Second Assessment Report: Climate Change 1995 (SAR)
- Jakobsen 2012. S.B. Jakobsen *Fuel Optimisation on 2-Stroke Engines*, 3rd Propulsion Conf., Trans IMarEST, London 2012
- Lamb 1948. Lamb, J. The burning of boiler fuels in marine diesel engines. Trans IMarE, Vol.LX, No 1. (1948)
- Lambert, A. 2008. *Admirals*. Faber & Faber. ISBN 978-0-571-23156-0
- Larminie and Dicks, 2000. Larminie, J. and Dicks *Fuel cell systems explained*. Wiley, Chichester ISBN 0 471 49026 1
- Lloyd's Register 2011. *Bio-fuel Trials on Seagoing Container Vessel*. Maersk-Lloyd's Register-Shell Research Consortium SMIG 09004, Lloyd's Register, July 2011
- Lloyd's Register. 2012. *Lloyd's Register LNG Bunkering Infrastructure Study*. Lloyd's Register, London February 2012.
- Loginow A.W., 1989, *Stress Corrosion Cracking of Steel in Liquefied Ammonia Service - A Recapitulation*, <http://www.nationalboard.org/Index.aspx?pageID=182>
- MacKay 2009. MacKay, D. *Sustainable Energy-Without the Hot Air*. ISBN 078-0-9544529-3-3
- MacKay 2011. MacKay, D. Lecture to the Royal Academy of Engineering's Working Group. 2011
- MOL, 2004. MOL 2004 Ministry of Land, Infrastructure and Transport (Japan): *The Survey on Transport Energy 2001/2002* MOL(Japan): Environmental and Social Report 2004
- Pomeroy, R.V. 2010. *250 Years of Marine Technology Development*. Proc. Lloyd's Register Technology Days 2010. Lloyd's Register, London
- Rice 1961. Rice, W.A. *US Patent 2997013*, 22 August 1961
- Royal Academy of Engineering. 2009. *Synthetic Biology: scope, applications and implications*. The Royal Academy of Engineering, London May 2009
- Royal Society and Royal Academy of Engineering, 2012. *Shale gas extraction in the UK: a review of hydraulic fracturing*. The Royal Society & Royal Academy of Engineering, London June 2012
- Royal Society, 2012. *People and the Planet*. The Royal Society, Report. April 2012
- Stanford 1. [http://me.stanford.edu/research/centers/ahpcrc/Project1\\_6.html](http://me.stanford.edu/research/centers/ahpcrc/Project1_6.html)
- Stanford 2. <http://npl-web.stanford.edu/archive/all-electron-battery/>
- Stopford, M. 2012. *Engineering Change in the Merchant Fleet*. Address to the Royal Academy of Engineering, London. 10th October 2012
- Troberg, 2012. Troberg, M. 3rd Ship Propulsion Conference, Trans IMarEST. London, November 2012
- TICA 2012, Turbine Inlet Cooling Association, <http://turbineinletcooling.org/intro.html>
- Veldhuis, I., 2007. Application of Hydrogen Marine Systems in High-speed sea container transport, Eng.D Thesis, University of Southampton. <http://eprints.soton.ac.uk/51284/>
- Wilson, 2012. Wilson, T. 3rd Ship Propulsion Conference, Trans IMarEST. London, November 2012



# Appendices

## Appendix 1

### Terms of reference

The terms of reference of the Royal Academy of Engineering's Alternative Methods of Ship Propulsion Working Group are as follows:

1. To assess the future prospects of current methods of merchant ship propulsion in terms of environmental impacts and sustainability.
2. To explore the feasibility of employing alternative means of propulsion for merchant ships with particular focus on nuclear power. These alternative means are to be placed within the contexts of other existing or known potential ship powering options.
3. The working group is to comprise representatives from a range of marine and other related and interested communities based either in the United Kingdom or abroad.
4. A broad range of ship types, sizes and trading patterns are to be considered.
5. The scope of the discussions are to include, but not necessarily be limited to, the technical, operational, commercial, regulatory, risk, legal, environmental, public acceptability, and health and safety considerations.
6. Publicly available reports are to be produced at appropriate stages in the work of the working group.
7. The governance of the working group is to be vested in an elected Chair and Deputy Chair in whom and through whom the terms of reference are to be implemented and publications authorised in accordance with the requirements of the Royal Academy of Engineering.

## Appendix 2

### Membership of the working group

#### Chairman

Professor JS Carlton FREng      City University London

#### Members

Mr J Aldwinkle	Anthem Corporate Finance
Mr J Anderson	Caledonian Marine Assets
Professor C Arcoumanis FREng	City University London
Mr D Balston	Chamber of Shipping
Mr A Bardot	International P&I Clubs
Mr C Beall	Shell Shipping Technology
Mr M Bowker	Institute of Marine Engineering, Science and Technology
Professor R Bucknall	University College London
Mr W Catford	Surrey University
Mr J Cheetham	Lloyd's Register
Mr J Clench	City University London
Mr S Clews	BP Ltd
Mr D Davenport-Jones	American Bureau of Shipping
Mr M Drayton	The Baltic Exchange
Mr A Duncan	Caledonian Marine Assets
Mr M Edmondson	Chubb Insurance
Dr M El-Shanaway	International Atomic Energy Authority
Mr S Firth	MOD(N) Submarine Operating Centre
Mr D Forbes	Rolls Royce plc
Mr A Goldsworth	Rolls Royce plc
Dr A Greig	University College London
Rear Admiral N Guild FREng	Engineering Council
Mr S Hall	American Bureau of Shipping
Mr D Hankey	BAE Systems
Ms E Hauerhof	City University London
Mr V Jenkins	Lloyd's Register
Mr C Joly	Carnival CTS

Mr G Kirk	IED Nottingham University
Mr R Lockwood	Nuclear Institute
Professor D MacKay FRS	Chief Scientific Advisor, DECC
Dr J Kang	Samsung Heavy Industries Co Ltd
Mr P Nash	Royal Haskoning DHV
Professor M Newby	City University London
Ms P Oldham	Institution of Mechanical Engineers
Mr W Page	Wärtsilä UK Ltd
Mr SM Payne OBE, FREng	Consultant (Chairman of Working Group in 2009)
M J-P Roux	Areva TA
Dr P Sargent	DECC
Mr R Smart	Lloyd's Register
Mr D Strawford	Carnival CTS
Mr M Tetley	Nuclear Risk Insurers Ltd
Professor S Turnock	University of Southampton
Mr R Vallis	BAE Systems Marine Division
Mr A Walker	Royal Academy of Engineering
Dr A Watt	University of Glasgow and Strathclyde
Mr G Wright	MOD(N) Submarine Operating Centre
Professor P Wrobel FREng	University College London

## Appendix 3

### Referee and review group

Vice Admiral Sir Robert Hill KBE, FREng	Safety, Reliability and Marine Consultant
Mr B Cerup-Simonsen	Maersk Maritime Technology
Professor D Stapersma	Delft University of Technology
Mr R Taylor FREng	National Nuclear Laboratory
Mr R Vie	Carnival Shipbuilding

## Appendix 4

### Statement from Vice-President of the European Commission SiimKallas and EU Commissioner for Climate Action Connie Hedegaard, October 2012.

“Shipping is a global industry and needs global solutions to address its environmental footprint. As a result, we are all working towards an internationally agreed global solution to decrease greenhouse gas emissions from ships. The International Maritime Organisation made a significant and highly welcome step forward in July 2011 with the Energy Efficiency Design Index. But this measure alone – which is applied only to new ships from 2015 – will not be enough to ensure shipping emissions are reduced fast enough. Discussions about further global measures are ongoing at IMO level, but we need intermediary steps to quickly deliver emissions reductions, such as energy efficiency measures also for existing ships.

At EU level, we consider several options, including market-based mechanisms. A simple, robust and globally-feasible approach towards setting a system for monitoring, reporting and verification of emissions based on fuel consumption is the necessary starting point. This will help make progress at a global level and feed into the IMO process. It’s therefore our joint intention to pursue such a monitoring, reporting and verification system in early 2013. At the same time, we will continue the debate with stakeholders on which measure can successfully address the EU’s greenhouse gas reduction objectives.

The shipping industry itself is best placed to take the lead in delivering fast and effective greenhouse gas emission reductions – thereby cutting cost and making the sector fit for the future. The Commission is ready to play its part, in the EU and at IMO level.”

## Appendix 5

### A ship systems approach

One starting point for a ship systems approach is to consider the plant requirements and undertake a stakeholder mapping exercise. However, the ship owner is only one of a complex network of stakeholders relating to the ship and its operation and their collective desires and requirements have to be relaxed such that a common perspective is reached. Capturing the views of these bodies can be difficult, but if it is not done effectively then key requirements may be missed and, if significant, there is a high probability that the ship may be unable to effectively trade.

The mode of operation required will determine a ship’s specific design requirements. This will impose different requirements on the ship’s subsystems, including the prime source of power. These requirements, in turn, will be heavily dependent upon the meta-solution, including the routes and the cargos being shipped as well as the sea states and other external factors. To then move from a requirements specification to the system solution and integrate the various technologies effectively, a functional understanding of the system is needed. This principally separates the various functions and shows the required essential flow of information between them. When complete, the intended function of the system can then be understood and used as a framework for the ship design process, after which the requirements for the various subsystems of the ship can be defined from the functional model. To improve the understanding of the entire ship system, sensitivity analyses can then be undertaken.

When a departure is made from conventional modes of propulsion, increased attention should be paid to the system reliability and, by implication, its availability. Furthermore, it needs to be recognised that costs for design changes generally increase significantly between each of the project stages. However, the quality of data and with it increased certainty, during a design and production exercise tends to increase as the project progresses. Therefore, in order to manage risk throughout the life cycle it is necessary to identify risks, then quantify those risks and communicate them.

The range of risks associated with the development of novel forms of propulsion in merchant ships can be appreciated from Table A5.1.

Safety
Financial costs
Market influences
Stakeholder requirements
Technical development risks
Management understanding
Warranty and servicing costs
Legal and statutory implications
Public liability and insurance costs

Table A5.1 Risk factors in new propulsion developments

There are different types of risk: human risk; technological risk; process risk and financial risk. Technical risk relates to the deployment of novel or variations of proven technology and the consequent availability of the ship to undertake its commercial role. Each of these risk elements has to be considered separately and uncertainties associated with each risk category identified.

Failure mode and effect analysis is frequently helpful in de-risking proposed conceptual designs, given that it is executed competently. Failure in this context is formally defined as an unplanned transition to a state in which the system either cannot perform at all or cannot properly perform its intended function: both being potentially dangerous. To consider a failure as a point event which occurs at a well-defined instant of time is frequently a serious oversimplification. Whenever there is a steady degradation of performance together with an arbitrary criterion of failure, appreciable information may be lost by studying only the time to failure. However, for high-integrity systems actual failure may be so rare that it will not provide useful information. In this context, Weibull lifetime modelling and Bayesian statistical approaches can be helpful and from these a design for reliability process can be defined.

The conclusion of this process is that the solution may appear to a ship owner to be what was originally desired, but having been through a systems engineering process ensures that it generally satisfies all stakeholder requirements.

## Appendix 6

### Further aspects relating to nuclear merchant ship propulsion

#### Fission process

Nuclear fission is induced when a free thermal neutron is absorbed in a large atom such as  $^{235}\text{U}$  or  $^{239}\text{Pu}$ . Absorption of this type causes instability and can set up vibrations within the nucleus which cause it to become distended to the point where it splits apart under mutual electrostatic repulsion of the parts. If this happens, the atom splits into fragments and energy is released. In the case of  $^{235}\text{U}$ , if a free neutron is absorbed into an atom, the  $^{235}\text{U}$  is converted into  $^{236}\text{U}$  which is highly unstable because of the neutron to proton ratio. Fissionable nuclei break-up occurs in a number of different ways: indeed the  $^{235}\text{U}$  nucleus may break up in some 40 or so different ways when it absorbs a thermal neutron. Typically, this might be to split into two fragments,  $^{140}\text{Xe}$  and  $^{94}\text{Sr}$  as well as emitting two neutrons; alternatively, the split may take the form of  $^{147}\text{La}$  and  $^{87}\text{Br}$  fragments plus two neutrons. All of the fission fragments are initially radioactive and the majority then undergo a decay process to stable daughter elements. For example, the  $^{140}\text{Xe}$  and  $^{94}\text{Sr}$  fragments are unstable when formed and, therefore, undergo beta decay. During this decay process the fragments emit an electron each after which they both become stable. The emitted two or three neutrons which themselves, after having their speed and energy moderated, may be captured by other  $^{235}\text{U}$  nuclei in an ongoing process called a chain reaction. Simultaneously with the formation of the emission fragments is the emission of gamma rays.

The simultaneous and progressive fission of a large number of atoms therefore creates a very large number of fission products which are highly radioactive isotopes of many varied and different elements, all of which, as soon as they are created, start to decay, giving off energy and radiation in the form of beta particles (electrons) and gamma rays. The fragments go through several stages of decay before becoming more-or-less stable elements. Quite soon after becoming critical and starting operation, the reactor core contains more than 200 radioactive species (*radionuclides*).

Thus energy in the form of heat and radiation is created not only by the fission chain reaction itself, but continues to be given off after the reactor is shut down by the insertion of control rods which soak up neutrons and stop the chain reaction. The energy of decaying fission products is known as decay heat.

#### Fuel enrichment

In PWR reactors only a small percentage of naturally occurring uranium is fissionable,  $^{235}\text{U}$ , which implies that uranium has to be enriched in its  $^{235}\text{U}$  component. While it is possible to achieve virtually any level of enrichment that is desired, uranium for use in civilian programmes is generally around 5% of  $^{235}\text{U}$ . Levels of enrichment of 20% or greater are subject to stringent controls due to international safeguards and nuclear weapons proliferation concerns and are only used in specialist or military applications. Furthermore, an increase in enrichment level, because there is more

#### DECAY HEAT

Decay heat is the heat produced by the radioactive decay of radioactive fission products after a nuclear reactor has been shut down. The amount of radioactive materials present in the reactor at the time of shutdown is dependent on the power levels at which the reactor operated and the amount of time spent at those power levels. Typically, the amount of decay heat that will be present in the reactor immediately following shutdown will be roughly 7% of the power level that the reactor operated at prior to shutdown,

which will decrease to about 2% of the pre-shutdown power level within the first hour after shutdown and to 1% within the first day. Decay heat will then continue to decrease, but it will decrease at a much slower rate. Decay heat will be significant weeks and even months after the reactor is shut down, thus the need for ongoing reactor cooling. Hence, nuclear powered ships, like nuclear power stations, require auxiliary generated electrical power for reactor cooling or general ship services when the reactor is shut down.

#### HALF LIFE

Radioactive half life is defined as the time it takes for the amount of a radionuclide to fall to one half of its original value. Take for example tritium, which has a radioactive half-life of 12.3 years and emits a very low energy beta particle when it undergoes radioactive decay and transforms to

stable, non-radioactive helium. If we originally take 1 million atoms of tritium ( $^3\text{H}$ ), after 12.3 years (half life) we would have 500,000 atoms of radioactive tritium left, with the other 500,000 atoms having radioactively decayed to non-radioactive helium ( $^3\text{He}$ ).

fissionable material, does not imply that the fuel will have a longer life in a reactor since other factors such as corrosion resistance or fuel element fatigue influence life expectation. Therefore, it is likely that a standard civil fuel of around 5% enrichment would be used in any merchant shipping application. Although not a  $\text{CO}_2$ -producing energy source, nuclear power produces waste products because following fission a number of radioactive products remain; many of which have long half-lives requiring a considerable period of storage before they cease to pose a radiological hazard.

#### Molten salt reactors

Molten salt reactors operate at atmospheric pressure and in this way avoid accident sequences that with other types of reactor originate with low pressure. The molten salt reactor operates at high temperature which, with appropriate generating plant, gives high thermal efficiency and high power to weight and size ratios. With regard to the high temperatures, there is a large ( $\approx 500^\circ\text{C}$ ) margin between the operating temperature and the boiling point of the fuel salt, allowing time to react in the event of loss of decay heat cooling. It is inherently stable and load following, with a quick response.

There is an abundant world supply of thorium, which is used in the reactor in its natural state, requiring no separation or pre-use processing. The earth's crust contains three times as much thorium as  $\text{U}^{238}$ . Moreover, the fuel salt can be contaminated so as to confer virtually insurmountable resistance to proliferation and its use in nuclear weapons.

After reprocessing, the wastes are predominantly short-lived fission products with relatively short half-lives. In a waste repository, safe radiation levels would be reached in 300 years, as opposed to the tens of thousands of years of actinides with much longer half-lives.

Set against these advantages there are some disadvantages of this technology. Pipes and components comprising the salt systems must be maintained above the high melting temperature of the salt until emptied by draining to the drain tank. Isolating the ship's structure and other compartments from the high-temperature systems and compartments is arguably the main problem facing the ship designer. Also, fuel salt drained from the reactor into the drain tank requires to be cooled to remove decay

heat and the cooling system needs high reliability. Furthermore, due to fission product activity, systems and components containing fuel salt are highly radioactive and remote maintenance equipment is needed. This also applies to the off-gas and drain tank systems. Additionally, the bare graphite used in the core is susceptible to distortion and damage in a high neutron flux. Finally, the fuel in a molten salt reactor is dispersed and this complicates the shielding requirements which are notably different to those of a PWR. The requirement to also thermally insulate the hot compartments exacerbates the naval architect's problems.

#### Ship concept design

Nuclear propulsion, if applied to merchant ships, would permit further concepts in ship design to be contemplated. For example, because nuclear fuel is relatively cheap, the conventional operating cost implications of high-speed operations do not apply. It might, therefore, become desirable to operate a container ship at 35 knots or a tanker at 21 knots in contrast to the lower conventional speeds. Such a concept might save the deployment of one ship on a liner route when moving a fixed volume or weight of cargo. Alternatively, it could give flexibility with a full complement of ships to accommodate predicted increasing trade volumes. A further design dimension, due to the small mass and volume of fuel consumed, may give scope for increased cargo deadweight capacity or, alternatively, provide greater flexibility in hull design to satisfy other constraints which might not normally be able to be relaxed. If the former of these options were taken, the propeller power density might become too large for an acceptable propulsion solution using a single screw. This might dictate that a twin or triple screw option was selected and while increasing building costs, might have helpful steering or propulsion redundancy aspects.

As with many other aspects of the design process for a nuclear-propelled ship, the design of the control system and the system integrity would form a central feature of the safety case. Indeed, it would be a complex matter to construct a fully integrated safety case for a ship-borne reactor plant and its supporting shore infrastructure to support a nuclear powered merchant ship. This is because a mobile reactor plant needs to be able to operate independently at sea and in at least two different dry-docks or ports: probably more if the ship undertook current commercial trading

patterns. However, to minimise complexity, duplication of systems and cost, it would be important that the designs of the reactor plant and shore infrastructure are coherent. In particular, a key objective for the mobile reactor plant would be to minimise the nuclear safety demands placed on the shore infrastructure.

Within the space available on a large merchant ship it may be possible to include many of the support systems that are required when a reactor is shut down for repair or refuelling. For example, alternative cooling water systems for decay heat removal and high integrity electrical power supplies could be supplied. However, with a small number of shore facilities supporting a relatively large number of ships, it may be more cost-effective to install these facilities on the dockside. By adopting a modular approach to nuclear plant design, typical of small modular reactors, work on a complete reactor plant module could be carried out at specialist facilities offsite, thereby easing dockside nuclear safety requirements. Clearly, a system engineering approach is required to consider these and other issues, thereby ensuring an optimum design solution for both merchant ship and shore infrastructure.

### Safety and life cycle issues

Radiation is a hazard to health, so the core of a nuclear reactor, where the fission takes place, must be shielded to prevent radiation reaching the operators and the general public. Furthermore, barriers must be provided to ensure that highly radioactive particles stay within the core. In a nuclear power station, the final barrier to the escape of radioactive particles to the environment is the containment building housing the nuclear plant.

The escape of radioactive particles from the core constitutes a nuclear accident, which may be quite small, easily contained and relatively harmless; or large, as in the cases of Chernobyl and Fukushima. A nuclear accident could result from core damage, such as distortion or melting, as a result of failure of the systems which take away the heat from fission and the decay heat after shutdown. Hence the safety case for a nuclear power plant not only demonstrates that the core can be taken critical; remain under control while operating and safely shut down, but also demonstrates that throughout the whole of the life of the core, cooling systems will be available to take away both the heat when it is operating and the decay when it is shut down.

Nuclear safety considerations will drive different shore infrastructure requirements from those currently in place for conventionally propelled merchant ships. These would impact on factories, shipyards, ports and dockyards throughout the whole life cycle of the nuclear propulsion plant and, in so doing, would be a major cost driver for nuclear powered merchant shipping. There would be a number of life cycle requirements that would need to be satisfied:

**Design:** A design assessment would be required to justify the intended type of reactor plant to be used in the ship.

**Manufacture:** Special facilities would be required for the manufacture of reactor plant components, and in the case of the reactor core these facilities would be need to be within a licensed site. The factories already in place for civil nuclear programmes could, however, most likely be used.

**Build and commissioning:** Although aspects of conventional marine plant require clean conditions for assembly, the requirements for nuclear plant in cleanliness, quality assurance, procedural control and inspection would be demanding. This implies fabricating as much of the reactor plant as possible in dedicated manufacturing facilities offsite and then installing completed modules: this again might favour integral reactor plant designs and small modular reactors. The presence of nuclear fuel onsite requires facilities to be designed to consider a range of external hazards, from earthquake to aircraft impact. Furthermore, reactor plant commissioning would require high-integrity electrical and cooling water supplies, facilities to handle radioactive discharges, and robust emergency response arrangements. The latter requirements would be simplified if the shipyard was distant from large centres of population. Within the shipyard, docks, tidal berths and cranes would also require safety cases, and special arrangements would be needed to ensure safe exit from the shipyard. Throughout the build and commissioning a significant level of regulatory oversight would be expected.

**Operation:** There would need to be some interaction with shore infrastructure whenever cargo is loaded or unloaded and, more particularly, if the reactor had to be shut down for unplanned repair. The repair facilities employed would have to consider the use of high-integrity power supplies, cooling water supplies to remove decay heat, and the ability to handle low-level radioactive discharges. The operation of nuclear-powered merchant ships in ports close to centres of population will require appropriate nuclear emergency response plans and arrangements to be put in place which may, in certain quarters, have some negative effects on public perception. Entry into navigationally difficult port approaches would also require appropriate assistance and emergency response arrangements. Indeed the operation of LPG carriers already addresses similar issues. The use of offshore terminals might form the basis of an appropriate goods distribution solution but would add cost to the transportation chain. Clearly, it would be desirable to use ports remote from the general public access and to design reactor plants to minimise dependence on shore facilities when shut down for repairs. Additionally, within the operational framework there would be a need to introduce security measures to protect nuclear material on a mobile platform.

### Refuelling and major maintenance and repair:

Currently available reactor plants for merchant ships would require refuelling at regular intervals. To minimise ship downtime, these periods might be planned to coincide with routine dockings and major maintenance, inspection or repairs. The shore infrastructure requirements would be similar to those for the build and commissioning phases, however, due to the increased radiological hazard associated with

used nuclear fuel they would be more demanding. Again, these issues could be simplified if the advantages of a plant modular approach were adopted with complex work undertaken off-ship or even offsite.

**Decommissioning:** The principle of designing reactor plant with decommissioning in mind should apply. However, by the time marine plant decommissioning and disposal are likely to become issues for nuclear-powered merchant ships, effective arrangements for land-based nuclear plants may be in place. When these have been established they could absorb the relatively small contribution from the maritime domain, particularly if modular construction and deconstruction is employed. If repositories have not been established by then, the currently established plan of holding spent fuel in surface cooling ponds could be utilised.

A number of dismantling options are available. The immediate dismantling and safe storage options have been used, in part, for the *Otto Hahn* and *Savannah* respectively. Indeed, the *Otto Hahn*, following its successful period as a nuclear-propelled merchant ship demonstrator, went on to have a long career as a diesel-propelled cargo ship.

### Cost models

Figure A6.1 shows the historical trend in uranium oxide prices, from which some volatility can be seen. However, only around 52% of the cost of uranium fuel comprises the cost of uranium, to which enrichment and fabrication costs of approximately 26% and 7% respectively must be added: the balance of the total cost being conversion and waste processing and storage costs (Dundee 2007). Figure A6.2 records the historical trends in electricity production costs

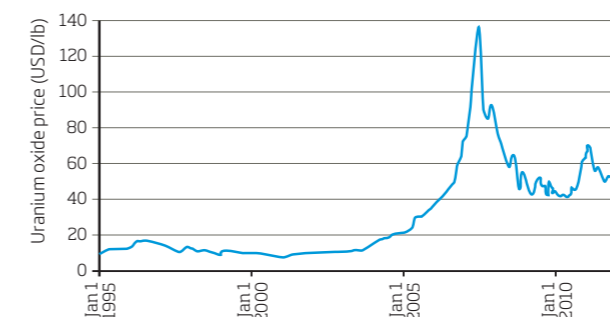

Figure A6.1 Historical trends in uranium oxide prices [InfoMine.com]

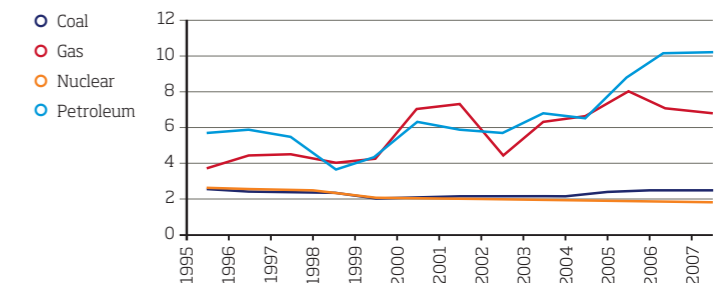

Figure A6.2 US Electricity production costs 1995–mid 2008 [NEI Global Energy Decisions]

from four fuel sources. Nuclear, along with coal, has a record of being the cheapest and also is subject to less volatility in production costs than other fuel sources. Long-term users of nuclear fuels usually enter into long-term contracts with producers at term prices and in recent years the term prices have shown significant reductions against the spot prices. These contracts are typically three to five years in duration and use a variety of pricing mechanisms: fixed price contracts with escalation clauses linked to market indicators being but one example.

In the marine context there are many variables involved in the business and operational models underpinning ship propulsion business cases. In the context of fuel prices as oil prices change, the cost of operating conventionally propelled vessels varies accordingly, subject to the provisions of hedging arrangements, whereas Figure A6.2 demonstrates that the electricity production cost of running a nuclear generation plant has remained relatively stable over the last 12 to 13 years. Furthermore, the current term contract durations used in the land-based industries fit well with conventional marine survey and major maintenance cycles and from which similar fuel cost benefits might be derived.

### Insurance

The insurance of nuclear risks is subject to the same principles as other insurance. However, the insurance of nuclear risk is different from other insurance risks because, however improbable, a reactivity excursion or the failure to prevent overheating by removing decay heat can result in core melting. This may result in extensive plant damage and external radioactive contamination if other barriers are breached. This entrains a series of issues which can be summarised as being:

- Events of potentially very high severity, but low frequency.
- A low number of nuclear risks having a premium in 2010 of the order of \$800M globally which is about 0.04% of the total global premium.
- There is insufficient actuarial data upon which to base an idea of the risk; there are only theoretical calculations as the industry loss record is good.
- The attendant risk of accumulation of financial exposure.

## Appendix 7

### International atomic energy principles and requirements

The fundamental safety objective is to protect people and the environment from harmful effects of ionising radiation.

#### Principles

To achieve the fundamental safety objective there are ten principles [A7.1] which are required to be applied.

- 1. Responsibility for safety**  
The prime responsibility for safety must rest with the person or organisation responsible for facilities and activities that give rise to radiation risks.
- 2. Role of government**  
An effective legal and governmental framework for safety, including an independent regulatory body, must be established and sustained.
- 3. Leadership and management for safety**  
Effective leadership and management for safety must be established and sustained in organisations concerned with, and facilities and activities that give rise to, radiation risks.
- 4. Justification of facilities and activities**  
Facilities and activities that give rise to radiation risks must yield an overall benefit.
- 5. Optimisation of protection**  
Protection must be optimised to provide the highest level of safety that can be reasonably achieved.
- 6. Limitation of risks to individuals**  
Measures for controlling radiation risks must ensure that no individual bears an unacceptable risk of harm.
- 7. Protection of present and future generations**  
People and the environment, present and future, must be protected against radiation risks.
- 8. Prevention of accidents**  
All practical efforts must be made to prevent and mitigate nuclear or radiation accidents.
- 9. Emergency preparedness and response**  
Arrangements must be made for emergency preparedness and response for nuclear or radiation incidents.

### 10. Protective actions to reduce existing or unregulated radiation risks

Protective actions to reduce existing or unregulated radiation risks must be justified and optimised.

#### Requirements

The ten principles that are set out above in order to achieve the fundamental safety objective lead, inter alia, to the requirement for a safety assessment to be carried out. The following 24 requirements (A7.2), therefore, are directed towards the proper achievement of the safety assessment.

#### 1. Graded approach

A graded approach shall be used in determining the scope and level of detail of the safety assessment carried out in a particular state for any particular facility or activity, consistent with the magnitude of the possible radiation risks arising from the facility or activity.

#### Overall requirements

- 2. Scope of the safety assessment**  
A safety assessment shall be carried out for all applications of technology that give rise to radiation risks; that is, for all types of facilities and activities.
- 3. Responsibility for the safety assessment**  
The responsibility for carrying out the safety assessment shall rest with the responsible legal person; that is, the person or organisation responsible for the facility or activity.
- 4. Purpose of the safety assessment**  
The primary purpose of the safety assessment shall be to determine whether an adequate level of safety has been achieved for the facility or activity and whether basic safety objectives and safety criteria established by the designer, the operating organisation and the regulatory body, in compliance with the requirements for protection and safety as established in the International Basic Safety Standards for Protection against Ionising Radiation and the Safety of Radiation Sources (A7.3), have been fulfilled.

**5. Preparation for the safety assessment**

The first stage of carrying out the safety assessment shall be to ensure that the necessary resources, information, data, analytical tools as well as safety criteria are identified and are available.

**6. Assessment of the possible radiation risks**

The possible radiation risks associated with the facility or activity shall be identified and assessed.

**7. Assessment of safety functions**

All safety functions associated with a facility or activity shall be specified and assessed.

**8. Assessment of site characteristics**

An assessment of the site characteristics relating to the safety of the facility or activity shall be carried out.

**9. Assessment of the provision for radiation protection**

It shall be determined in the safety assessment for a facility or activity whether adequate measures are in place to protect people and the environment from harmful effects of ionising radiation.

**10. Assessment of engineering aspects**

It shall be determined in the safety assessment whether a facility or activity uses, to the extent practicable, structures, systems and components of robust and proven design.

**11. Assessment of human factors**

Human interactions with the facility or activity shall be addressed in the safety assessment, and it shall be determined whether the procedures and safety measures that are provided for all round operational activities, in particular those that are necessary for implementation of the operational limits and conditions, and those that are required in response to anticipated operational occurrences and accidents, ensure an adequate level of safety.

**12. Assessment of safety over the lifetime of a facility or activity**

The safety assessment shall cover all the stages in the lifetime of a facility or activity in which there are possible radiation risks.

**Defence in depth and safety margins**

**13. Assessment of defence in depth**

It shall be determined in the assessment of defence in depth whether adequate provisions have been made at each of the levels of defence in depth.

**Safety Analysis**

**14. Scope of the safety analysis**

The performance of a facility or activity in all operational states and, as necessary, in the post-operational phase shall be assessed in the safety analysis.

**15. Deterministic and probabilistic approaches**

Both deterministic and probabilistic approaches shall be included in the safety analysis.

**16. Criteria for judging safety**

Criteria for judging safety shall be defined for the safety analysis.

**17. Uncertainty and sensitivity analysis**

Uncertainty and sensitivity analysis shall be performed and taken into account in the results of the safety analysis and conclusions drawn from it.

**18. Use of computer codes**

Any calculation method and computer codes used in the safety analysis shall undergo verification and validation.

**19. Use of operating experience data**

Data on operational safety performance shall be collected and assessed.

**Documentation**

**20. Documentation of the safety assessment**

The results and findings of the safety assessment shall be documented.

**Independent verification**

**21. Independent verification**

The operating organisation shall carry out an independent verification of the safety assessment before it is used by the operating organisation or submitted to the regulatory body.

**Management, use and Maintenance of the Safety Assessment**

**22. Use of the safety assessment**

The processes by which the safety assessment is produced shall be planned, organised, applied, audited and reviewed.

**23. Use of the safety assessment**

The results of the safety assessment shall be used to specify the programme for maintenance, surveillance and inspection; to specify the procedures to be put in place for all operational activities significant to safety and for responding to anticipated operational occurrences and accidents; to specify the necessary competences for the staff involved in the facility or activity and to make decisions in an integrated, risk-informed approach.

**24. Maintenance of the safety assessment**

The safety assessment shall be periodically reviewed and updated.

**References for Appendix 7**

- 7.1 Fundamental Safety Principles: Safety Fundamentals. IAEA Safety Standards Series No. SF-1, IAEA, Vienna, 2006.
- 7.2 Safety Assessment for Facilities and Activities. General Safety Requirements Part 4, No. GSR Part 4, IAEA, Vienna, 2009.
- 7.3 International Basic Safety Standards for the Protection against Ionizing Radiation and for the Safety of Radiation Sources. IAEA Safety Series No115, IAEA, Vienna, 2006.

## Appendix 8

### The energy efficiency design index

The computation of the actual EEDI for a specific ship design, for which the Index applies, is achieved through the use of following relationship which embraces the four CO<sub>2</sub> potentially producing components in the numerator while in the denominator is the product of

ship speed and capacity. It will also be seen that in both the numerator and denominator there are number correction factors included which adjust the value of the Index for particular circumstances. The actual EEDI is then given by:

Actual EEDI =

$$\frac{\prod_{j=1}^M \left( \sum_{i=1}^{n_{ME}} P_{ME(i)} C_{FME(i)} SFC_{ME(i)} \right) + (P_{AE} C_{FAE} SFC_{AE}) + \left( \prod_{j=1}^M \sum_{i=1}^{n_{PTI}} P_{PTI(i)} - \sum_{i=1}^{n_{eff}} f_{eff(i)} P_{AEff(i)} \right) C_{FAE} SFC_{AE} - \left( \sum_{i=1}^{n_{eff}} f_{eff(i)} P_{eff(i)} C_{FME} SFC_{ME} \right)}{f_i \cdot C_{DWT} \cdot V_{ref} \cdot f_w}$$

where:

<p><b>C<sub>DWT</sub></b> capacity is the ship's capacity measured in deadweight or gross tonnage at the summer load line. In the case of container ships this is taken as 70% of the deadweight. [tonnes]. [MEPC 63/23 Annex 8].</p> <p><b>C<sub>FAE</sub></b> is the carbon factor for the auxiliary engine fuel. [gCO<sub>2</sub>/g<sub>fuel</sub>]</p> <p><b>C<sub>FME</sub></b> is the carbon factor for the main engine fuel. [gCO<sub>2</sub>/g<sub>fuel</sub>]</p> <p><b>EEDI</b> is the actual energy efficiency design index for the ship. [gCO<sub>2</sub>/tonne.nm]</p> <p><b>f<sub>eff</sub></b> is a correction factor for the availability of innovative technologies.</p> <p><b>f<sub>i</sub></b> is a correction factor for the capacity of ships with technical or regulatory limitations in capacity.</p> <p><b>f<sub>j</sub></b> is a correction factor for ships having specific design features: for example, an ice breaker.</p> <p><b>f<sub>w</sub></b> is a correction factor for speed reduction due to representative sea conditions.</p> <p><b>M</b> is the number of propulsion shafts possessed by the ship.</p> <p><b>n<sub>eff</sub></b> is the number of innovative technologies contained within the design.</p> <p><b>n<sub>ME</sub></b> is the number of main engines installed in the ship.</p>	<p><b>n<sub>PTI</sub></b> is the number of power take-in systems.</p> <p><b>P<sub>AE</sub></b> is the ship's auxiliary power requirements under normal seagoing conditions. [kW]</p> <p><b>P<sub>EAEff</sub></b> is the auxiliary power reduction due to the use of innovative technologies. [kW]</p> <p><b>P<sub>eff</sub></b> is taken as 75% of the installed power for each innovative technology that contributes to the ship's propulsion. [kW]</p> <p><b>P<sub>ME</sub></b> is the ship's main engine installed power [kW]</p> <p><b>P<sub>PTI</sub></b> is taken as 75% of the installed power for each power take-in system. For example, propulsion shaft motors. [kW]</p> <p><b>SFC<sub>AE</sub></b> is the specific fuel consumption for the auxiliary engines as given by the NO<sub>x</sub> certification. [g/kWh]</p> <p><b>SFC<sub>ME</sub></b> is the specific fuel consumption for the main engines as given by the NO<sub>x</sub> certification. [g/kWh]</p> <p><b>V<sub>ref</sub></b> is the ship speed under ideal sea conditions when the propeller is absorbing 75% of the main propulsion engine(s) MCR when the ship is sailing in deep water.</p>
--	---

## Appendix 9

### Calendar for main emission legislation events 2010-2020

1 July 2010	Tier II NO <sub>x</sub> limit for new engines [Global]
1 July 2011	US Caribbean Sea ECA adopted at IMO MEPC 62
1 Jan 2012	Cap on sulphur content of fuel <sup>(a)</sup> 4.50% to 3.50% [Global]
1 Aug 2012	North American ECA took effect SO <sub>x</sub> and NO <sub>x</sub> <sup>(b)</sup> [Local]
1 Jan 2014	US Caribbean Sea ECA takes effect SO <sub>x</sub> and NO <sub>x</sub> <sup>(b)</sup> [Local]
1 July 2015	ECA cap on sulphur content of fuel 1.00% to 0.10% [Local]
1 Jan 2016 <sup>(c)</sup>	Tier III NO <sub>x</sub> limit for new engines NO <sub>x</sub> ECA's only [Local]
1 Jan 2020 <sup>(d)</sup>	Cap on sulphur content of fuel 3.50% to 0.50% [Global]

#### Notes

- a SO<sub>x</sub> emissions are being controlled by reducing the percentage of sulphur in the fuel. It is permissible to use fuel with a higher sulphur content than the local limit so long as it can be shown that by using some appropriate technology the SO<sub>x</sub> content of the exhaust is no higher than if fuel was burnt that is within the local limit.
- b At Tier II until 1 Jan 2016 then Tier III.
- c Subject to technical review to be concluded no later than 2013; this could be delayed.
- d Subject to feasibility review to be completed by 2018.



## Appendix 10

### Potential applicability of measures and options discussed

Ship type	Tanker/Bulk carriers			Container ships			Ro/Ro & ferries			Cruise ships		
	NB	ES	Op	NB	ES	Op	NB	ES	Op	NB	ES	Op
<b>Conventional propulsion options</b>												
Diesel engines incl. modifications												
Biofuels												
Natural gas (LNG)												
Gas turbines												
<b>Other propulsion technology options</b>												
Nuclear												
Batteries												
Fuel cells												
Renewable energy												
Hydrogen												
Anhydrous ammonia												
Comp air/nitrogen												
Hybrid propulsion												
<b>Further propulsion considerations</b>												
Energy-saving devices												
Hull optimisation and appendages												
Hull coatings												
Hull cleaning												
Propeller redesign to suit operational profile												
CRP propulsion												
Propeller cleaning												
Superconducting electric motors												
Weather routing and voyage planning												
Slow steaming and/or propeller mod.												
Machinery condition monitoring												
Crew training												

NB New building  
 ES Existing ship  
 Op Operational measure

The above options do not take account of time frame in that some options would have a relatively long lead time; see Figure 5.1. Additionally, the presence of a shaded block suggests there may be merit in considering these options for many cases of ships conforming to the general type. The absence of a shaded block does not necessarily imply there is no merit in the option for the class of ship since many variants, including operational profiles, exists within ship types.

Ship type	General cargo ships			Offshore support vessels			Tugs			Fishing vessels		
	NB	ES	Op	NB	ES	Op	NB	ES	Op	NB	ES	Op
<b>Conventional propulsion options</b>												
Diesel engines incl. modifications												
Biofuels												
Natural gas (LNG)												
Gas turbines												
<b>Other propulsion technology options</b>												
Nuclear												
Batteries												
Fuel cells												
Renewable energy												
Hydrogen												
Anhydrous ammonia												
Comp air/nitrogen												
Hybrid Propulsion												
<b>Further propulsion considerations</b>												
Energy-saving devices												
Hull optimisation and appendages												
Hull coatings												
Hull cleaning												
Propeller redesign to suit operational profile												
CRP propulsion												
Propeller cleaning												
Superconducting electric motors												
Weather routing and voyage planning												
Slow steaming and/or propeller mod.												
Machinery condition monitoring												
Crew training												

NB New building  
 ES Existing ship  
 Op Operational measure

The above options do not take account of time frame in that some options would have a relatively long lead time; see Figure 5.1. Additionally, the presence of a shaded block suggests there may be merit in considering these options for many cases of ships conforming to the general type. The absence of a shaded block does not necessarily imply there is no merit in the option for the class of ship since many variants, including operational profiles, exists within ship types.



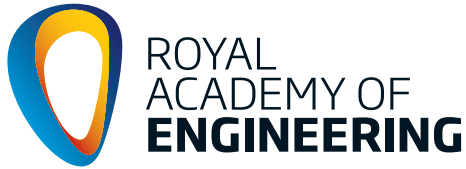

As the UK's national academy for engineering, we bring together the most successful and talented engineers from across the engineering sectors for a shared purpose: to advance and promote excellence in engineering.

We provide analysis and policy support to promote the UK's role as a great place from which to do business. We take a lead on engineering education and we invest in the UK's world class research base to underpin innovation. We work to improve public awareness and understanding of engineering. We are a national Academy with a global outlook.

The Academy's work programmes for 2011 to 2015 are driven by four strategic challenges:

**Drive faster and more balanced economic growth**

**Foster better education and skills**

**Lead the profession**

**Promote engineering at the heart of society**

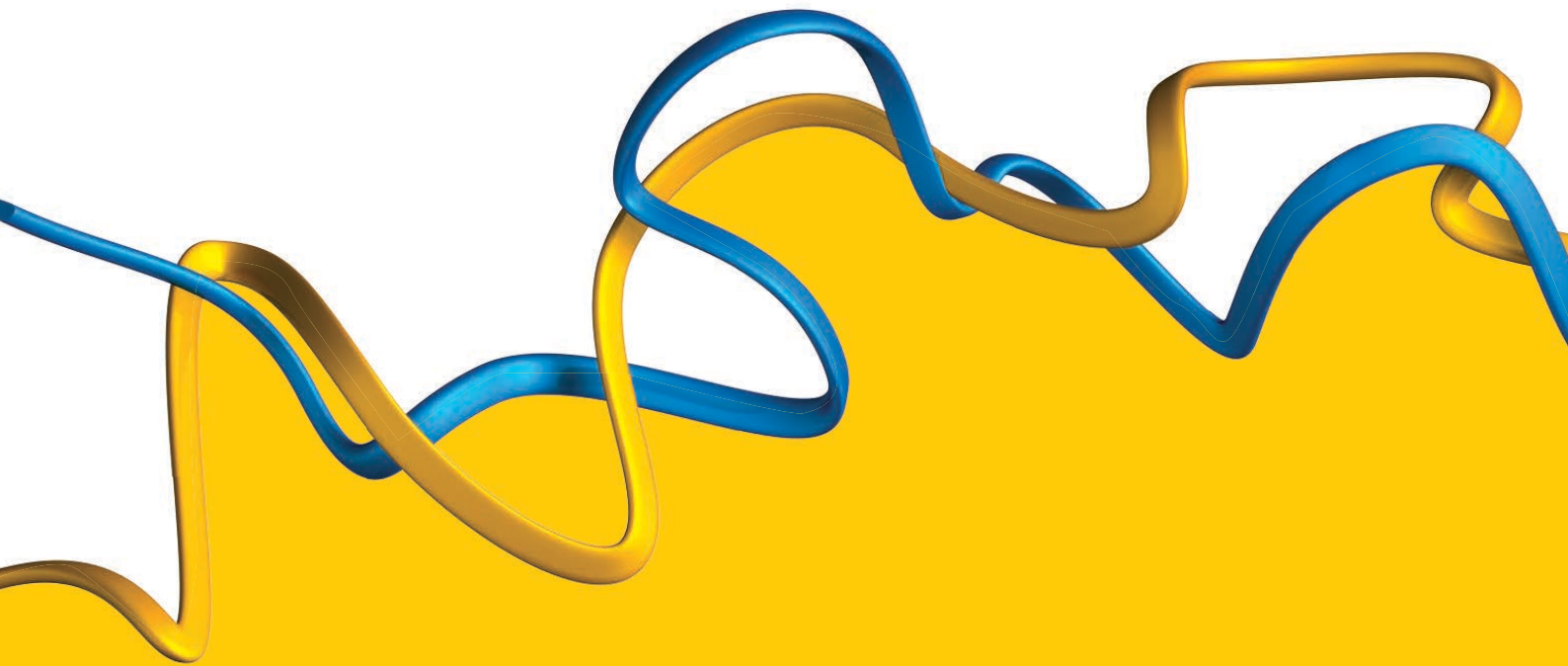

Royal Academy of Engineering  
Prince Philip House  
3 Carlton House Terrace  
London SW1Y 5DG

Tel: +44 (0)20 7766 0600  
[www.raeng.org.uk](http://www.raeng.org.uk)

Registered charity number 293074



Please recycle this brochure