

# Sustainability of **liquid biofuels**



---

© Royal Academy of Engineering

July 2017

[www.raeng.org.uk/biofuels](http://www.raeng.org.uk/biofuels)

ISBN: 978-1-909327-34-4

Published by

Royal Academy of Engineering

Prince Philip House

3 Carlton House Terrace

London SW1Y 5DG

Tel: 020 7766 0600

Fax: 020 7930 1549

[www.raeng.org.uk](http://www.raeng.org.uk)

Registered Charity Number: 293074

All photos © istock, Shutterstock and Alamy.

# Contents

<b>Executive summary</b>	<b>2</b>		
Sustainability of biofuels - a complex topic	2		
The carbon footprints of biofuels	2		
Other sustainability issues	3		
A risk-based approach	3		
A systems view and ecosystem services	3		
Recommendations for improvements	3		
Summary of policy recommendations	4		
<b>Glossary</b>	<b>6</b>		
<b>1. Introduction</b>	<b>10</b>		
1.1. Aim of the study	10		
1.2. Definition of biofuels	11		
1.3. Study methodology and coverage	12		
1.3.1. Literature review	12		
1.3.2. Stakeholder input	12		
<b>2. History of biofuels and policy landscape</b>	<b>14</b>		
2.1. History of biofuels	14		
2.2 Policy landscape	14		
2.2.1. EU Renewable Energy Directive (RED)	14		
2.2.2. Renewable Transport Fuel Obligation (RTFO)	16		
<b>3. Current and future supply of biofuels</b>	<b>17</b>		
3.1. Current supply	17		
3.1.1. Global production	17		
3.1.2. Supply in the UK	17		
3.2. Future supply	19		
3.2.1. Global production	19		
3.2.2. Supply in the UK	21		
<b>4. Key sustainability issues associated with liquid biofuels</b>	<b>24</b>		
<b>5. Methods, standards and certification schemes for assessing sustainability of biofuels</b>	<b>25</b>		
5.1. Life cycle assessment	25		
5.1.1. Type of LCA approach: attributional vs. consequential	25		
5.1.2. LCA standards	26		
5.1.3. Greenhouse gas (GHG) standards	26		
5.2. Sustainability standards	27		
5.3. Certification schemes	27		
<b>6. Overview of life cycle assessment studies</b>	<b>32</b>		
6.1. Goal and scope of studies	32		
6.2. Functional units	33		
6.3. Allocation methods	33		
6.4. Land use change: direct and indirect	34		
6.5. Biogenic carbon	35		
6.6. Soil organic carbon	38		
6.7. Emissions of soil nitrous oxide	38		
6.8. Assumptions and uncertainties	39		
<b>7. Overview of environmental sustainability of biofuels</b>	<b>42</b>		
7.1. Carbon footprint of biofuels	42		
7.1.1. First generation biofuels	42		
7.1.2. Second generation biofuels	44		
7.1.3. Third generation biofuels	45		
7.2. Energy use	46		
7.3. Water use	46		
7.4. Biodiversity	48		
7.5. Other environmental impacts	49		
<b>8. Overview of socio-economic sustainability of biofuels</b>	<b>50</b>		
8.1. Social impacts	50		
8.1.1. Food security, energy security and rural development	50		
8.1.2. Employment, labour-related issues and land rights	52		
8.1.3. Air quality and human health issues	53		
8.1.4. Further considerations	53		
8.2. Economic impacts	54		
8.2.1. Competitiveness with fossil fuels	54		
8.2.2. Costs of producing biofuels	54		
8.2.3. Cost of waste feedstocks and potential for fraud	55		
<b>9. Summary of findings and recommendations for improvements</b>	<b>56</b>		
9.1. Improving the evidence base	57		
9.1.1. Life cycle assessment	57		
9.2. Robust auditing of sustainability	59		
9.3. Developing a risk-based approach	60		
9.4. Integrated management of ecosystem services	61		
<b>10. Policy recommendations</b>	<b>63</b>		
<b>References</b>	<b>65</b>		
<b>Appendices</b>	<b>82</b>		
Appendix 1: List of working group members and external reviewers	82		
Appendix 2: Terms of reference	83		
Appendix 3: Summary of stakeholder input	85		
Appendix 4: Carbon footprint of biofuels (Supplementary information)	88		



Bioethanol plant

## Executive summary

### Sustainability of biofuels - a complex topic

Gauging the sustainability of liquid biofuels is a complex undertaking. However, complexity is no excuse for inaction as liquid biofuels will be needed if the UK's ambitious decarbonisation targets are to be met. The Academy's work on future energy systems shows that all possible low-carbon technologies and fuels will be needed to reach 80% carbon reduction by 2050, as legislated in the Climate Change Act. Biofuels will be particularly needed in aviation, shipping and heavy goods vehicles where there are few alternatives to fossil fuels other than biofuels.

There is still some way to go before a more complete understanding and comprehensive methodological approaches to sustainability assessment are developed. Such approaches must consider a wide range of environmental, economic and social aspects. Even focusing only on the carbon footprint of biofuels - one of the main drivers for their development - brings with it a host of uncertainties. Moreover, almost every aspect related to biofuels is dynamic in nature across different scales, which adds to the complexity. Examples include changes in soil carbon content over time (micro-scale); time needed to replace vegetation used as feedstock for biofuels (meso-scale); and development of global biofuel supply chains (macro-scale). Considering these dynamic aspects and their interconnections presents a considerable challenge.

In an attempt to provide greater clarity on the topic, this study considers the most significant sustainability issues associated with liquid biofuels, the methods available for assessing them and the associated uncertainties, with the aim of supporting future policy decisions. While the main focus of the study is on the carbon footprints of different biofuels, other environmental, economic and social issues related to their production and use are also discussed.

### The carbon footprints of biofuels

It is essential that the carbon footprint and other sustainability aspects of biofuels be evaluated on a life cycle basis across full supply chains to avoid shifting the burdens from one part of the life cycle or supply chain to another. Most sustainability studies of biofuels to date have focused on their environmental impacts and, in particular, on the carbon footprint. Life cycle assessment (LCA) is the main tool used and some 250 LCA studies were investigated in

## IT IS IMPORTANT TO TAKE INTO ACCOUNT THAT BIOFUELS DO NOT EXIST IN ISOLATION BUT ARE PART OF MUCH WIDER SYSTEMS, INCLUDING ENERGY, AGRICULTURE AND FORESTRY.

preparing this report. Two types of LCA approaches are applied in practice: attributional and consequential. Attributional LCA accounts for impacts directly related to biofuels, attributing them to various activities in a specific supply chain, including production and use of biofuels. In contrast, consequential LCA examines potential indirect consequences of biofuels by considering various 'what if' scenarios that could arise from their production, such as changes in demand for feedstocks or technological improvements.

Every LCA study of biofuels will have been designed to address a specific question and will contain different assumptions, data sources and uncertainties. Therefore, it is not surprising that the results vary widely across the studies and care must be taken in making direct comparisons between them.

Despite variability, LCA studies demonstrate that, if no land-use change is involved, first generation biofuels (those produced from food or animal feed crops) can - on average - meet the greenhouse gas (GHG) emissions savings relative to fossil fuels required by the EU Renewable Energy Directive (RED). However, second generation biofuels (from dedicated energy crops, waste and residues) have in general a greater potential than first generation biofuels to reduce GHG emissions, again provided there is no land-use change. Third generation biofuels (produced from microalgae) do not represent a feasible option at present state of development as their GHG emissions are higher than those from fossil fuels.

### Other sustainability issues

In addition to the carbon footprint, there are many other sustainability issues that must be considered when assessing the sustainability of biofuels. These include: costs of production and competitiveness with fossil fuels; food, energy and water security; employment provision; rural development; and human health impacts. These are discussed in this report but have received relatively little attention to date and should be considered further in future policy.

### A risk-based approach

One of the key aspects in developing biofuels policy should be to ensure that risks from their production and consumption are

minimised along whole supply chains. The aim of a risk-based approach is to promote those feedstocks and biofuels that present a low risk of high GHG emissions and other sustainability impacts while strongly disincentivising high-risk alternatives. For example, feedstocks that result in either deforestation or drainage of peat lands are considered high risk and should be avoided.

An example of a risk-based approach is that proposed by the Department for Transport in relation to the proposed changes to the Renewable Transport Fuels Obligation (RTFO). This includes:

- setting a cap on the supply of crop-based biofuels to mitigate the risk of an increase in indirect land-use change
- introducing targets for fuels derived from wastes and residues and incentivising their production
- ensuring that genuine wastes and residues are used and that they are not diverted from applications that are more environmentally sustainable.

### A systems view and ecosystem services

It is also important to take into account that biofuels do not exist in isolation but are part of much wider systems, including energy, agriculture and forestry. Like other production systems with which they interact, biofuels impact on various ecosystem services, such as land, water and food. It is, therefore, essential to take an integrated, systems view to developing future policy to ensure that biofuels are not disadvantaged relative to other sectors or that progress made in this sector is not undone by unsustainable practices in others.

### Recommendations for improvements

#### Life cycle assessment of biofuels

- To increase the utility of LCA as an evidence-based tool for evaluating the environmental sustainability of biofuels, the methodologies and practical applications of both attributional and consequential LCA need to be improved. This also includes improving the clarity with which studies and their findings are communicated.



# COMPLETE VALUE CHAINS RATHER THAN SINGLE BIOENERGY PRODUCTS SHOULD BE ANALYSED TOGETHER, TAKING A SYSTEMS APPROACH, TO UNDERSTAND THE INTERACTIONS ACROSS SECTORS AND LAND USES AND IDENTIFY OPPORTUNITIES WHERE COLLECTIVE BENEFITS CAN BE REALISED.

- There is a need to validate indirect land-use change models used in consequential LCA with empirical evidence; empirical methods are also needed to test alternative hypotheses.
- To improve transparency, data availability and sharing, open national and global LCA databases should be developed.
- All LCA studies should include uncertainty and sensitivity analyses to improve the reliability of the findings and give more confidence in policy or decision making based on these studies.

## Robust auditing of sustainability

- Robust auditing of biofuel supply chains should continue to be strengthened to ensure that criteria on sustainability, governance and transparency are enforced.
- Measures should be taken to ensure that all certification schemes account for any significant negative sustainability impacts. The transparency and governance of some schemes also needs to be improved.
- The verification of the origin of wastes and residues used for second generation biofuels should be strengthened to ensure traceability and reduce the potential for fraudulent activities. A national database should be established, alongside a centralised international database, to ensure traceability of the fuels and to mitigate the risk of fraud. It is also necessary to use a means to detect and resolve alleged infringements of schemes' rules or to verify that complaints are registered and appropriately acted upon.

## Developing a risk-based approach

- Sustainability assessment of biofuels should consider a range of relevant environmental, economic and social aspects to avoid solving one issue (eg. climate change) at the expense of another.
- Robust and transparent methods for sustainability assessment should be developed taking a life cycle approach and integrating different aspects of sustainability.
- To help deal with the complexity associated with such approaches, further development of risk-based approaches to biofuels according to feedstock type and geographical origin is needed.

- Stakeholder involvement in the development of risk-based approaches would ensure their relevance and would facilitate implementation.

## Integrated management of ecosystem services

- Work is needed to strengthen sustainability governance across the different sectors that biofuels are part of, including energy, agriculture, forestry and other land-based supply chains.
- Since biofuel production is often embedded in supply chains for existing products and can have its own co-products, complete value chains rather than single bioenergy products should be analysed together, taking a systems approach, to understand the interactions across sectors and land uses and identify opportunities where collective benefits can be realised.

## Summary of policy recommendations

### The following priority steps by government are needed in the short term:

- Incentivise the development of second generation biofuels, in the first instance those derived from wastes and agricultural, forest and sawmill residues, followed by dedicated energy crops. The proposed sub-targets for these fuels and the continuation of the double-counting mechanism, both proposed in the 2017 revision of the RTFO, are reasonable steps to take.
- Set a cap for the supply of all crop-based biofuels to reduce the risk of indirect land-use change.
- Where possible, incentivise the use of marginal land (eg. land unsuitable for food production or degraded through deforestation) for the production of biofuels, particularly if soil-carbon stocks can be restored through use.
- Provide and maintain a clear and consistent categorisation of wastes and residues that will avoid unintended market distortions within the UK and internationally.
- Disincentivise feedstocks that have the potential to drive unsustainable land-use change, primarily deforestation and peat land drainage.



Field of rapeseed

- Increase the level of biofuels required under the RTFO to drive the development of the sector and increase competitiveness of biofuels as well as help towards meeting climate change mitigation targets.

Some of the above recommendations are already being considered by government and we strongly encourage their implementation.

**Within the next five years, the following steps by government are needed:**

- Work to develop an integrated approach towards land-use planning that integrates and optimises ecosystem services.
  - Integrate consideration of biofuels in rural land-use planning and agricultural incentive schemes.
  - Continue to play a role in the development and use of consequential LCA (CLCA) to drive methodological improvements, including the models used, data, assumptions and their verification. Consensus building and standardisation of CLCA should be the goal.
  - Work towards applying CLCA across the full breadth of land-uses and alternative products that biofuels are compared with, including fossil fuels, to understand better the dynamics of land use by different sectors as well as to ensure a fair treatment of biofuels.
  - Until a more comprehensive understanding of land-use systems is available, adopt a risk-based approach to biofuels policy. Key components of this should be:
    - further CLCA studies aimed at informing biofuels policies
    - continued regional assessments of biofuels production
    - robust local audit and certification systems
    - inclusion of social and economic impacts.
  - Strengthen the assessment by which existing certification schemes are recognised by the European Commission and ensure that robust certification of biofuel supply chains is maintained when the UK leaves the EU.
- Consider other sustainability issues beyond the carbon footprint, including competitiveness of biofuels with fossil fuels, food, energy and water security, employment provision, rural development and human health impacts. The latter is particularly important in view of the current debate on emissions and health impacts from diesel vehicles.
  - Consider introducing different incentive bands for second generation biofuels. This would provide differentials in the incentives structure for biofuels that are in earlier stage of development and require a greater incentive than the proven options (eg. first generation fuels).
  - Take a more active role in public engagement and debate. Key areas of debate that need to be drawn out include food security, the relationship between investment in agriculture and investment in biofuels, as well as the need to develop biofuels for key transport sectors that lack other low-carbon options (road freight, shipping and aviation).

# Glossary

**Acidification:** Change in a natural chemical balance in waterways or soil caused by an increase in the concentration of acidic substances, such as sulphur dioxide and nitrogen oxides, washed out from the atmosphere.

**Agricultural residues:** Biomass obtained from agricultural activities as a natural by-product of the main crop, including straw and processing residues, such as husks, chaff, cobs or bagasse. These can be used for the production of second generation biofuels.

**Allocation:** A term used in life cycle assessment. It involves partitioning the inputs into, or emissions from a multifunctional system between its different functions or outputs, such as different co-products.

**Biodiesel:** An oil based biofuel, typically produced from vegetable fats, such as rapeseed, sunflower seed, soya bean and palm oil, and blended with conventional diesel for use in motor vehicles.

**Biodiversity:** The variety of different life forms in a given area. High biodiversity is viewed as an indication of a healthy ecosystem.

**Bioenergy:** Energy from biomass with most common applications in the transport, heat and electricity sectors.

**Bioethanol:** An alcohol based biofuel, typically produced from starch and sugar crops, such as wheat, corn, barley and sugar beet or cane, and blended with petrol for use in motor vehicles.

**Biofuel:** A fuel produced from biomass. The two most common types of biofuel are bioethanol and biodiesel. Biofuels are also distinguished by the type of feedstock from which they are produced as first, second and third generation:

- **First generation biofuels (also referred to as 'conventional' biofuels):** Biofuels produced from food or animal feed crops. Bioethanol is obtained by microbial fermentation of sugars from sugar- or starch-based crops, such as sugar cane, sugar beet, corn and wheat. Biodiesel is produced by transesterification, whereby lipids (oils and fats) in edible oil, such as palm, soybean and rapeseed, are reacted with alcohols (ethanol or methanol).
- **Second generation biofuels (also referred to as 'advanced' biofuels):** Biofuels derived from dedicated energy crops (eg. *Miscanthus*, switchgrass, short rotation coppice and other lignocellulosic plants), agricultural residues, forest and sawmill residues, wood wastes and other waste materials (eg. used cooking oil and municipal solid waste). A key characteristic is that these feedstocks cannot be used for food.

- **Third generation biofuels (also referred to as 'advanced' biofuels):** Biodiesel produced from microalgae through conventional transesterification or hydro-treatment of algal oil.

**Biogenic carbon:** In the context of biofuels, this term refers to CO<sub>2</sub> that is sequestered from the atmosphere during the growth of feedstocks and subsequently released during the combustion of the biofuel or via decomposition of vegetation or biological waste (eg. forest residues).

**Biomass:** Organic matter used for the production of biofuels. Other uses include conversion into heat and electricity and production of chemicals.

**Blending obligation:** A requirement on transport fuel suppliers to ensure that a certain proportion of fuel is supplied from renewable sources and blended with conventional fossil fuels.

**Blue water:** Fresh surface and groundwater, in other words, the water in freshwater lakes, rivers and aquifers.

**Carbon defaults (or 'default values'):** Default carbon intensity (or greenhouse gas emission) of biofuels expressed in grams of CO<sub>2</sub> equivalent per megajoule of fuel used (g CO<sub>2</sub> eq./MJ). Under the EU Renewable Energy Directive, these values can be used in place of specific assessment of biofuel supply chains in Europe, provided a regional assessment has determined that supply chains in that region are equivalent or below the carbon default value.

**Carbon footprint:** Total life cycle emissions of greenhouse gases from a system, expressed in carbon dioxide equivalents (CO<sub>2</sub> eq.). For biofuels, the life cycle typically includes cultivation and harvesting or collection of feedstocks (as relevant), their processing, production and use of biofuels, waste management and all intermediate transportation steps.

**Certification:** An inspection (audit and certification) procedure by means of which the conditions for issuing a certificate to an operator are assessed by an appropriate certification body.

**Counterfactual scenario:** 'Counter to the facts' or 'what if' scenarios related to the possible consequences of a given action, such as producing biofuels.

**Cradle to gate:** Life cycle stages from the extraction of raw materials ('cradle') to the point at which the product leaves the production facility ('gate').

**Cradle to grave:** Life cycle stages from the extraction of raw materials ('cradle') to final disposal of waste ('grave').



**Double counting:** An incentive placed on biofuels produced from waste, residues, non-food cellulosic material and lignocellulosic material, whereby they receive double credits by volume towards the targets in the Renewable Transport Fuel Obligation and the Renewable Energy Directive.

**Ecosystem services:** Environmental resources used by humans, including clean air, water, food and materials. According to the Millennium Ecosystem Assessment, ecosystem services can be classified into: i) supporting services (eg. photosynthesis, nutrient and water cycling), ii) provisioning services (eg. food, water), iii) regulating services (eg. air quality, climate etc. regulation) and iv) cultural services (eg. recreational amenities and aesthetic value of landscape).

**Energy crops:** As opposed to some crops that can be used for the production of biofuels but also have food and feed markets, dedicated energy crops are grown specifically for the purpose of producing heat, electricity or transport biofuels. Dedicated energy crops are non-food crops, including *Miscanthus*, switchgrass, short rotation coppice and other lignocellulosic plants as well as non-food cellulosic material, except saw logs and veneer logs, which have an alternative market outlet.

**EU Biofuels Directive:** Originally Directive 2003/30/EC, later amended by Directive 2009/28/EC (see 'EU Renewable Energy Directive'). It stipulated implementation of national measures by member states aimed at replacing 5.75% of all transport fossil fuels (petrol and diesel) with biofuels.

**EU Fuels Quality Directive (FQD):** Directive 98/70/EC (as amended), requiring suppliers to reduce the life-cycle greenhouse gas intensity of transport fuels and introducing sustainability criteria for biofuels.

**EU ILUC Directive:** Directive 2015/1513 amends the Renewable Energy Directive and the Fuel Quality Directive to take account of the effect of indirect land-use change (ILUC) and aims to encourage the transition away from first generation biofuels.

**EU Renewable Energy Directive (RED):** Directive 2009/28/EC of the European Parliament and of the Council of 23 April 2009 on the promotion of the use of energy from renewable sources and amending and subsequently repealing Directives 2001/77/EC and 2003/30/EC. The RED requires member states to ensure that 10% of the energy used in transport is from renewable sources by 2020.

**EU Waste Framework Directive:** EU Directive 2008/98/EC. Sets the basic concepts and definitions related to waste and lays down some basic waste management principles, including the waste hierarchy (see also 'waste hierarchy').

**Eutrophication:** Excessive enrichment of an aquatic ecosystem with nutrients (such as nitrates and phosphates) that favour the growth of algae and plants. Eutrophication can lead to the death of other organisms in the aquatic system as algae and plants deplete the oxygen in the system by covering the surface of the water and through their subsequent decay.

**Fatty Acid Methyl Esters (FAME):** Produced by the chemical reaction (transesterification) of vegetable or animal fats with alcohols, typically methanol or ethanol. A mixture of fatty-acid-methyl-esters, or 'FAME', is commonly referred to as biodiesel.

**Feedstock (for biofuels):** Matter of biological origin (biomass) used to produce biofuels.

**Forest residues:** In this report, forest residues refer to: i) the tree branches and tops that result from the harvesting of wood products within forests, also known as 'harvesting residues'; and ii) wood resulting from management practices to control the establishment, growth, composition and health of forests, referred to as 'thinnings'. Forest residues may also include damaged or diseased trees. Forest residues are a potential feedstock for the production of second generation biofuels.

**Fungible fuels:** Fuels in common use and with common specifications that can be intermixed without affecting the specified fuel quality and performance.

**Functional unit:** A measure of the function of the system of interest and used as a unit of analysis in life cycle assessment (LCA). For example, 1 MJ is often used as the functional unit in LCA studies of biofuels, reflecting its main function as the provision of transportation energy.

**Global warming potential (GWP):** Cumulative radiative forcing from the emission of a unit mass of a greenhouse gas relative to carbon dioxide. The radiative forcing effect is integrated over a period of time: 20, 100 or 500 years, with 100 years being used most often. GWP is expressed in carbon dioxide equivalents (CO<sub>2</sub> eq.) where GWP of one mass unit of CO<sub>2</sub> is equal to one. In life cycle assessment, the term GWP is used to denote the climate change impact from the total emissions of greenhouse gas from a system and is often used interchangeably with the term 'carbon footprint'.

**Greenhouse gases (GHG):** Gases in the atmosphere that absorb and re-emit infrared radiation reflected from the Earth. This causes the so-called 'greenhouse effect' whereby heat is trapped in the atmosphere making the Earth warmer and leading to climate change. The Kyoto Protocol covers a basket of six GHGs produced by human activities: carbon dioxide (CO<sub>2</sub>), methane (CH<sub>4</sub>), nitrous oxide (N<sub>2</sub>O), hydrofluorocarbons (HFCs), perfluorocarbons (PFCs) and sulphur hexafluoride (SF<sub>6</sub>).

**Green waste:** Biodegradable waste from gardens and parks, such as grass cuttings and hedge trimmings.

**Green water:** The precipitation on land that does not run off or recharge the groundwater but is stored in the soil or temporarily stays on top of the soil or vegetation.

**Hotspot:** A unit process or a life-cycle stage that has a potentially significant environmental, social and/or economic impacts.

**Hydro-treated vegetable oil (HVO):** A diesel that can be produced from a wide array of vegetable oils and fats that are treated thermo-chemically with hydrogen.

**ISO:** International Organisation for Standardization.

**Land-use change (LUC):** Change in the purpose for which land is used by humans (eg. crop land, grass land, forest land, wetland, industrial land). Two types of LUC are distinguished:

- **Direct LUC:** Change in the use of land at the location of production of the product of interest.
- **Indirect LUC:** Change in the use of land elsewhere occurring indirectly as a result of displaced demand previously destined for food, feed and/or fibre markets owing to biofuel demand.

**Life cycle assessment (LCA):** A method used to quantify environmental impacts of products, technologies or services on a life-cycle basis. An LCA study can be from 'cradle to grave' or from 'cradle to gate'. A cradle-to-grave study of a product considers all life-cycle stages from extraction of materials and fuels ('cradle') through production and use of the product to its final disposal as waste ('grave'). A 'cradle-to-gate' study does not follow the product to the use stage but stops at the factory 'gate' where the product has been produced.

**Marginal land:** Degraded or generally poor quality land, unsuitable for agricultural, housing and other uses.

**Microalgae:** Microscopic algae ranging in size from a few micrometres (µm) to a few hundred micrometres. They can be cultivated in freshwater and marine systems for production of third generation biofuels (biodiesel). For simplicity, the term 'microalgae' is used interchangeably with 'algae' in this report.

**Natural capital:** Natural resources such as soil, air, water and all living things. They provide a wide range of services, often called ecosystem services, which contribute to human well-being (see also 'ecosystem services').

**NGO:** Non-governmental organisation.

**Photochemical smog:** Ground-level (troposphere) ozone created by various chemical reactions between volatile organic compounds and nitrogen oxides in sunlight, also often referred to as 'summer smog'.

**Renewable Transport Fuel Certificate (RTFC):** One RTFC is awarded for every litre of liquid biofuel reported in the UK. Biofuels from waste, residues, non-food cellulosic material and lignocellulosic material receive double the number of RTFCs (see 'double counting'). RTFCs can be traded between suppliers. Their value is determined by the market.

**Renewable Transport Fuel Obligation (RTFO):** Introduced in 2008, the UK's main mechanism for supporting the supply of renewable fuels in transport. It places an obligation on suppliers with more than 450,000 litres per year of fuel, intended for road transport and non-road mobile machinery use, to ensure a certain percentage of the fuel supplied is renewable and operates as a certificate (RTFCs) trading scheme.

**Sawmill residues:** Waste chippings, sawdust, processing residues, shavings and off-cuts from sawmills.

**Soil organic carbon:** Carbon present in soils as organic matter. It includes carbon in living plants and in materials derived from plant remains, such as humus and charcoal.

**Supply chain:** The whole production chain from the production of feedstock for the production of biofuels up to the biofuel producer or trader.

**System boundary:** The boundary drawn around the system of interest, denoting unit processes and stages in the life cycle considered in a life cycle assessment study.

**System expansion or substitution:** Applied in life cycle assessment studies to estimate environmental impacts of the product of interest produced in a system that also co-produces other products. The system boundary is expanded to consider alternative ways of producing the co-products. The system is 'credited' for displacing (substituting) the need for these alternative production systems by subtracting their impacts from the overall impacts of the system under study.

**Toxicity:** The degree to which a substance can harm a living organism. In general, two types of toxicity are distinguished:

- **Human toxicity:** Impact on human health from exposure to harmful/toxic substances, carcinogenic and non-carcinogenic.
- **Eco-toxicity:** Impact of harmful/toxic substances on aquatic, terrestrial and sediment ecosystems.

**Used cooking oil (UCO):** A feedstock used for the production of second generation biofuels.

**Verification:** The process of providing assurance of biofuel sustainability data or other fuel-related data (eg. place of purchase, volume produced) supplied on behalf of reporting parties. Verifiers must be independent of the reporting party whose data they are verifying.

**Voluntary certification scheme:** Certification system established to provide assurance that biofuels meet certain sustainability criteria. The European Commission currently recognises 19 voluntary certification schemes as complying with the Renewable Energy Directive (RED). Schemes vary significantly in intention, geographical coverage, scope, organisation and governance and can apply both stricter and additional criteria beyond the mandatory criteria in the RED.

**Waste hierarchy:** A waste management strategy defined in the EU Waste Framework Directive (EU Directive 2008/98/EC) that prioritises respectively the prevention, re-use, recycling and recovery of waste products over disposal.

**Well to tank (WTT):** The life-cycle of a fuel from extraction (well) to delivery of the fuel to vehicles (tank). For biofuels, 'extraction' refers to feedstock cultivation or acquisition, as appropriate. Compared to well-to-wheel (WTW) (see below), WTT does not take into consideration fuel use in vehicle operations. It is equivalent to the 'cradle-to-gate' approach in life cycle assessment.

**Well to wheel (WTW):** The life cycle of a fuel from extraction (well) to its use in vehicles (wheel). For biofuels, 'extraction' refers to feedstock cultivation or acquisition, as appropriate. It is equivalent to the 'cradle-to-grave' approach in life cycle assessment.

**Wood wastes:** Waste wood from construction and demolition.



Urban congestion

# 1. Introduction

## 1.1. Aim of the study

Liquid biofuels currently make up about 3% of total road and non-road mobile machinery fuel supplies in the UK<sup>[1]</sup>. While transport fuels are not the first target for cost-effective carbon emission reductions, deep reductions in carbon emissions from transportation are essential if the UK is to meet its climate change obligations. The Academy's work on future energy systems<sup>[2]</sup> states that all possible low-carbon technologies and fuels will be needed to reach the 80% carbon reduction by 2050, as legislated by the Climate Change Act<sup>[3]</sup>. Developing viable liquid biofuel industries and markets is a long-term undertaking that could contribute to this goal, in particular in sectors such as aviation, shipping and heavy goods vehicles where substitution with electric vehicles is not a prospect in the short term, so significant efforts are already under way.

It is important that the reductions in life-cycle greenhouse gas (GHG) emissions that can be achieved by biofuels relative to their fossil fuel equivalents are properly understood to inform policy development and choice of best fuel options. Numerous studies have considered the potential of biofuels to achieve reductions in life cycle GHG emissions by estimating their carbon footprint. However, their findings are often conflicting, with a wide variation in the estimates. Thus, the main objective of this study is to provide a greater clarity and understanding of the carbon footprints of different liquid biofuels with the aim of informing future policy. A further objective is to investigate state-of-the-art knowledge of other sustainability issues – environmental, economic and social – associated with their production and consumption. As part of that, the current expectations for the development of biofuels and potential levels of supply that the UK could sustain in the future are also considered. The study also reviews methods, standards and regulations for assessing the sustainability of biofuels and makes recommendations for policy development.

Currently, UK biofuels policy is driven by EU Directives in terms of both the amount used and sustainability criteria. Following the result of the EU referendum in June 2016, the UK will need to decide upon its national policies and their relationship to EU biofuels directives and regulations. However, until the UK actually leaves the EU, it will continue to follow these regulations. Hence, this study has been carried out in this context.

The main focus of the study is on:

- liquid biofuels currently used in the UK
- emerging liquid biofuels proposed for large-scale use in the UK.



# IF THE UK IS TO MEET ITS CLIMATE CHANGE OBLIGATIONS, DEEP REDUCTIONS IN CARBON EMISSIONS FROM TRANSPORTATION ARE ESSENTIAL.

In both of the above cases, this covers both domestically produced and imported biofuels.

The study was carried out by the Royal Academy of Engineering under the auspices of the Academy's Engineering Policy Committee (EPC) and was overseen by an expert working group established by the Academy. Members of the working group are listed in Appendix 1. This report was reviewed internally by the Academy's EPC and by external experts, also listed in Appendix 1. The original terms of reference for the study can be found in Appendix 2.

## 1.2. Definition of biofuels

The term 'biofuels' commonly refers to liquid fuels that are derived from biomass, such as biodegradable agricultural, forestry or fishery products, wastes or residues, or biodegradable industrial or municipal waste. Biofuels can be differentiated according to a number of key characteristics, including feedstock type, conversion process, technical specification of the fuel and its use. Owing to this multitude of possible distinctions, various definitions are in use for biofuel types. Two commonly used typologies, are 'first, second and third generation' and 'conventional and advanced' biofuels (Table 1) and can be defined as:

- **First generation biofuels** (also referred to as 'conventional' biofuels): Biofuels produced from food or animal feed crops. Bioethanol is obtained by microbial fermentation of sugars from sugar- or starch-based crops, such as sugar cane, sugar beet, corn and wheat. Biodiesel is produced by transesterification, whereby lipids (oils and fats) in edible oil, such as palm, soybean and rapeseed, are reacted with alcohols (ethanol or methanol).
- **Second generation biofuels** (also referred to as 'advanced' biofuels): Biofuels derived from dedicated energy crops (eg. *Miscanthus*, switchgrass, short rotation coppice and other lignocellulosic plants), agricultural residues, forest and sawmill residues, wood wastes and other waste materials (eg. used cooking oil and municipal solid waste). A key characteristic is that these feedstocks cannot be used for food.
- **Third generation biofuels** (also referred to as 'advanced' biofuels): Biodiesel produced from microalgae through conventional transesterification or hydro-treatment of algal oil.

Since first generation biofuels, as defined above, are produced through well-understood technologies and processes, such as fermentation, distillation and transesterification, they are also commonly referred to as '**conventional biofuels**'. Second and third

generation fuels are often referred to as '**advanced biofuels**' as their production techniques or pathways are still in the research and development (R&D), pilot or demonstration phase.

While these distinctions are in common usage, they present some difficulties and need to be used with caution. Firstly, the same well-understood technologies and processes used to convert food or feed crops into 'conventional' or 'first generation' biofuels, can be used to convert many non-food or non-feed feedstocks into biofuels. As such, a fuel that some may refer to as 'advanced' may be advanced in so much as the feedstock is different (and potentially more challenging to convert into a fuel) while the technological process may in fact be the same.

The second main issue is related to defining wastes. Whether something is defined as a waste depends upon whether it has a pre-existing use or value, which is a contextual question. This is an issue if consistency is to be maintained. For example, as described in subsequent sections, the EU has introduced policy mechanisms whereby, to incentivise their production, biofuels derived from wastes, residues or other non-food biomass are 'double counted' towards obligations to blend low-carbon fuels into the fuel pool. Until a recent amendment to the EU Renewable Energy Directive (RED), in September 2015<sup>[4]</sup>, the same substance could be considered as having a use and therefore not being waste in one member state but considered as waste in another. For example, tall oil (from wood processing industries) is double counted in Sweden, but used as a chemical precursor in the UK and therefore not considered eligible<sup>[5]</sup>. Since the amendment in September 2015, the RED has a list of feedstocks for double-counted biofuels but still allows for the production of advanced biofuels in the installations existing prior to September 2015, the use of feedstocks not included in the list but determined to be waste by the competent national authorities. What is considered a waste may also change over time; as industries and policymakers increasingly turn their attention to making economies as 'circular' as possible, the value attached to materials that are currently treated as wastes is liable to change.

While these nuances and challenges with defining biofuels are significant and require a careful use of language, we have found it useful to differentiate between biofuels derived from different food and non-food feedstocks. Within the latter category, we distinguish between biofuels derived from dedicated energy crops, residues, wastes and algae. As such, for the purposes of this study, we have adopted the terminology of first, second and third generation biofuels and distinguish between them only by feedstocks as shown in Table 1.

**Table 1**  
**Biofuels classification according to the feedstock type adopted in this report, also showing an alternative classification and biofuel production processes and products [adapted from <sup>[8]</sup>]**

Classification (used in this report)	Alternative classification	Feedstocks	Production	Products
First generation	Conventional biofuels	Sugar crops Starch crops Vegetable oils	Transesterification Fermentation Hydrogenation Fischer-Tropsch	Bioethanol Biodiesel Methanol Butanol
Second generation	Ambiguous <sup>a</sup>	Used cooking oil Animal fats Energy crops	Gasification Pyrolysis Hydrolysis	Mixed alcohols Jet fuels Vegetable oil
	Advanced biofuels	Agricultural residues Forest residues Sawmill residues Wood wastes Municipal solid waste		
Third generation		Algae		

<sup>a</sup> Used cooking oil and animal fats are converted via well-established processes. Some energy crops compete with food or feed crops or cause land-use change; hence, they may not qualify as feedstocks for second generation (advanced) biofuels.

Table 1 also indicates that many different processes can be used to produce biofuels<sup>[6,7]</sup>. They are at varying degrees of maturity, with some being commonly labelled ‘conventional’, such as transesterification or fermentation and others as ‘advanced’, such as pyrolysis, gasification or hydrolysis. An in-depth discussion of these is outside the scope of this report; instead, we focus on the broad considerations that must be taken into account when assessing the sustainability of biofuels.

### 1.3. Study methodology and coverage

This study has relied on two main sources for collection of data and information: existing literature and an extensive consultation with key UK and international stakeholders. These are described below.

#### 1.3.1. Literature review

To identify relevant academic, peer-reviewed literature on the sustainability of biofuels, a systematic literature search was performed in relevant databases (Science Direct, Web of Science, Scopus and websites of relevant academic journals). Over 250 studies were identified and reviewed, including life cycle assessment (LCA) of biofuels and methodologies and policy aspects related to their sustainability. The reviewed studies covered a wide spectrum of first, second and third generation biofuels.

In addition, a systematic search of other publically available literature was conducted. This included publications by policy bodies (principally European Commission and the UK government), industry, commissioned works by think tanks and specialist consultancies, consortia of stakeholders – such as the Transport Energy Taskforce<sup>[9]</sup> – and non-governmental organisations (NGOs). These publications were prioritised for their relevance to the UK biofuels context.

To avoid outdated information, the review of both academic and other literature predominantly focused on the studies published from the period 2009 to 2017. Some important earlier publications that were frequently cited were also taken into account.

#### 1.3.2. Stakeholder input

Stakeholder input was received through a number of mechanisms:

1. A stakeholder mapping exercise was conducted and an open call for written evidence was issued and disseminated internationally on 21 March 2016. The call was also made public on the Academy’s website, promoted through its Fellowship and circulated throughout the International Council of Academies of Engineering and Technological Sciences (CAETS) Network.<sup>i</sup> The call remained open until 2 May 2016. In total, 37 written submissions of varying length were received.
2. Six oral evidence sessions were held whereby the study’s expert working group questioned panels of four to six different stakeholders on each panel. These sessions were used to either follow up with stakeholders who had submitted written evidence or as an opportunity to consult key stakeholders who had not participated in the call.
3. Follow-up interviews were held with some stakeholders who had not been able to feed into either of the above processes.
4. Finally, to test the predominantly UK-focused perspectives that had been gained in the oral evidence sessions and interviews, three teleconferences were held with panels of experts from Australia, Brazil and the U.S.

A total of 59 contributors inputted into the above processes, representing either organisations or individual experts from industry associations and partnerships, professional engineering institutions, biofuel producers, specialist consultancies, research institutions, labs, networks and NGOs. Appendix 3 provides an overview of the stakeholders consulted across these various input mechanisms.

<sup>i</sup> The international network of national academies focused on engineering and technological sciences ([www.caets.org/](http://www.caets.org/)).





Agricultural straw





Sugar cane

# 2.

## History of biofuels and policy landscape

### 2.1. History of biofuels

Biofuels have been used since the early days of the automotive industry. For instance, Rudolph Diesel tested his first engine on peanut oil<sup>[10]</sup> after pulverised coal was found to be unsuccessful. Until the 1940s, biofuels were seen as viable transport fuels and bioethanol blends such as 'Agrol', 'Discol' and 'Monopolin' were commonly used in the US, Europe and other regions<sup>[10]</sup>. Further development of bioethanol ceased after the Second World War as petroleum-derived fuel became cheaper. During the oil crisis in 1970s, many countries showed renewed interest in production of commercial biofuels; however, only Brazil started to produce ethanol at a large scale. In Brazil, blending ethanol from sugar cane into the fuel pool has been mandatory since 1977 and the government incentivised the development of 100% ethanol fuel vehicles and the associated distribution infrastructure.

During the late 1990s, with the rise in crude oil prices and concerns over energy security, the US and many nations in Europe developed policies in support of domestic biofuel industries<sup>[11]</sup>. The interest in biofuels further increased in the past decade with the development of policies on climate change mitigation and strategies to reduce GHG emissions from the transport sector. More than 60 countries have since launched biofuel programmes and set targets for blending biofuels into their fuel pools<sup>[9]</sup>. As a consequence, the biofuel sector has grown considerably in recent years and currently it contributes around 4% to transportation fuels globally<sup>[12]</sup>. However, this has also led to various controversies over the sustainability of biofuels production and use<sup>[13]</sup>, which has affected the growth of the sector<sup>[14]</sup>. The sustainability issues associated with liquid biofuels are discussed in the rest of this report, with a particular focus on their use in the UK. Prior to that, the next section provides an overview of the biofuels policy landscape in the EU and the UK, followed by their current and projected future production worldwide and in the UK.

### 2.2. Policy landscape

Two key policies applicable to biofuels in Europe and the UK are discussed in this section: the EU Renewable Energy Directive (RED) and the UK Renewable Transport Fuel Obligation (RTFO).

#### 2.2.1. EU Renewable Energy Directive (RED)

The RED is a common European framework intended to promote renewable energy sources. The 2009 Directive set mandatory



## IN BRAZIL, BLENDING ETHANOL FROM SUGAR CANE INTO THE FUEL POOL HAS BEEN MANDATORY SINCE 1977 AND THE GOVERNMENT INCENTIVISED THE DEVELOPMENT OF 100% ETHANOL FUEL VEHICLES AND THE ASSOCIATED DISTRIBUTION INFRASTRUCTURE.

national targets for the overall share of energy from renewable sources in gross final energy consumption and a minimum 10% share (on energy basis) of renewable energy in transport by 2020<sup>[15]</sup>. In practice, considering the present stage of technical development and possibilities to use alternative energies in transport, the 10% target can be achieved only through a substantial use of biofuels<sup>[15]</sup>.

RED Articles 17(2) to 17(6) set the following sustainability criteria for biofuels that have to be met for them to contribute towards national targets<sup>[15]</sup>:

- Minimum level of GHG savings: from 1 January 2017 this rose from 35% to 50% and will rise to 60% from 1 January 2018 for new plants commencing operations after 1 January 2017.
- Land criteria, excluding land with high biodiversity value, or change of use for high carbon stock or peat lands, with an emissions bonus of 29 g CO<sub>2</sub> eq./MJ for the use of restored degraded land.
- Agricultural raw materials cultivated in the EU and used for the production of biofuels shall respect the minimum requirements for good agricultural and environmental conditions and some statutory management requirements defined by the Common Agricultural Policy.

There are no mandatory requirements on maintaining and improving soil, water and air quality or for considering social issues, such as engagement with affected communities, compliance with the International Labour Organization's (ILO) conventions, or food security.

The RED legislation was amended through the Indirect Land-Use Change (ILUC) Directive 2015<sup>[4]</sup>, which limits the contribution of biofuels produced from crops grown on agricultural land to 7% of the final energy consumption in transport in member states by 2020. It also includes indicative support for second generation biofuels by:

- setting a target for 0.5% of the overall 10% share of renewable energy in transport by 2020, required by the RED, to be met by second generation biofuels
- allowing their contribution to be double-counted towards meeting the overall EU mandate, focusing on biofuels produced

from wastes, residues, non-food cellulosic and lignocellulosic materials. This means that fuel distributors can blend only half of the biofuel into fossil fuel to reach the requirements if the biofuel is produced from these feedstocks. At the national level, this also means that the member states can fulfil their target towards 10% share of renewable energy in transport with half the volume of biofuels.

EU member states are responsible for ensuring that the amounts of biofuels declared are backed by valid certificates and for collecting and sending these data to the Eurostat database where they are collated and made available in the public domain<sup>[16]</sup>. This is achieved in the UK through the RTFO, detailed below. To ensure that biofuels placed on the EU market are sustainable, member states must require economic operators in the biofuels supply chain to show that the sustainability criteria set out in the RED have been fulfilled<sup>[15]</sup>. Operators can show that their consignments of biofuel comply with the sustainability criteria by fulfilling the requirements of national control systems or by making use of voluntary schemes recognised by the European Commission<sup>[15]</sup>.

During the course of this study, the Commission announced a new package of policy proposals on the promotion of energy use from renewable sources<sup>[17]</sup>. This included an overarching target of at least 27% renewable energy across all energy sectors for the EU by 2030 to be fulfilled through a collective delivery of individual member states' contributions, where member states can set more ambitious national targets. Also proposed were the following revisions to the RED:

- With effect from January 2021, member states shall require transport fuel suppliers to provide an increasing share of renewable and low-carbon fuels, including a minimum share of energy from advanced biofuels, renewable transport fuels of non-biological origin (eg. hydrogen), waste-based fossil fuels<sup>ii</sup> and renewable electricity. The minimum share shall be at least 1.5% in 2021, increasing to 6.8% in 2030, including at least 3.6% from advanced biofuels. Preferential rules would apply to advanced aviation fuels in order to support their deployment in the aviation sector.
- The cap on the contribution of food-based biofuels towards the EU renewable energy target will decrease progressively from 7% in 2021 to 3.8% in 2030.

ii Where 'waste-based fossil fuels' are liquid and gaseous fuels produced from waste streams of non-renewable origin, including waste processing gases and exhaust gases.

# FROM 2021, BIOFUELS SHOULD HAVE AT LEAST 70% LOWER GHG EMISSIONS THAN FOSSIL FUEL ALTERNATIVES.

- From 2021, biofuels should have at least 70% lower GHG emissions than fossil fuel alternatives.
- New sustainability criteria will be introduced for forest biomass.
- National databases will be required to ensure traceability of the fuels and to mitigate the risk of fraud.

## 2.2.2. Renewable Transport Fuel Obligation (RTFO)

The RTFO<sup>[18]</sup> was introduced in the UK as a policy measure to encourage adoption of renewable transport fuels and to deliver the objectives set out in the European Commission's Biofuels Directive<sup>[19]</sup>. It came into force in April 2008 and it originally mandated a biofuel supply equivalent to 2.5% of total road transport fuel sales (by volume) in 2008/09, increasing to 4.75% by 2013. Until 2012, biofuels benefitted from £0.2/litre excise duty exemption. Refiners, importers and any others who supply more than 450,000 litres of road transport fuel per year to the UK market are required to conform to the RTFO.

In 2011, the RTFO was amended to introduce sustainability criteria and a double-counting mechanism for wastes, residues, non-food cellulosic material and lignocellulosic feedstocks to bring it in line with the RED. Since 2013, the UK blending target for all types of biofuels has remained at 4.75% of total volume of transport fuel used for road and non-road mobile machinery, principally owing to concerns related to the impacts of ILUC arising from production of first generation biofuels.

Under the RTFO system, suppliers of sustainable biofuel can apply for Renewable Transport Fuel Certificates (RTFCs). One RTFC is issued per litre of liquid or per kg of gaseous biofuel derived from crop-based feedstocks. Biofuels must be certified as meeting the sustainability criteria outlined in the RED to receive an RTFC. Obligated fuel suppliers are required to redeem a number of RTFCs in proportion to the volume of fossil fuel and unsustainable biofuel they supply. RTFCs are tradeable or fuel producers can pay a 'buy-out' price<sup>iii</sup> if they do not produce the required amount of biofuel.

As mentioned in the previous section, the RED stipulates that biofuels produced from second generation feedstocks shall be considered to 'count twice'. As such, biofuels derived from these feedstocks are issued two RTFCs per litre/kg<sup>[20]</sup>. The stakeholders consulted during the study generally agreed that this mechanism had been highly effective at incentivising the production of second generation biofuels, particularly those derived from wastes and residues. Of the 2,485 million RTFCs issued between April 2015 and April 2016, 1,840 million were issued to double-counting feedstocks<sup>[21]</sup>.



E10: 10% of ethanol blended with petrol

iii Currently 30 pence per litre of biofuel that would otherwise have had to have been supplied to meet their obligation.



Harvesting corn for bioethanol

# 3.

## Current and future supply of biofuels

### 3.1. Current supply

#### 3.1.1. Global production

Over the decade from 2005 to 2015, world bioethanol production increased by a factor of three, from 33 to 98.3 billion litres. During the same period, biodiesel production increased almost eight-fold, from less than four to 30.1 billion litres<sup>[12]</sup>. In 2015, biofuels accounted for about 4% of total transportation fuels worldwide<sup>[12]</sup>.

The global production of biofuels is dominated by the US and Brazil - producing 72% of all biofuels in 2015 - followed by Europe (EU-28), which produced 12%<sup>[12]</sup>. Production of bioethanol in the US is almost exclusively from corn, while sugar cane is used in Brazil. In Europe, the main feedstocks are corn for bioethanol and rapeseed for biodiesel production. Argentina, Brazil and the USA also produce significant quantities of biodiesel, predominantly from soybean, while Malaysia and Indonesia produce biodiesel from palm oil.

#### 3.1.2. Supply in the UK

In 2015/16, 1,565 million litres of biofuel were supplied in the UK, comprising 50% bioethanol, 47% biodiesel and 2% biomethanol. This is equivalent to 3% (by volume) of total road and non-road mobile machinery fuel (see Figure 1). Virtually all (99.9%) of the biofuel supplied met the sustainability requirements set by the RED<sup>[21]</sup>. As can be inferred from Figure 1, the growth of the biofuels market in the UK over the past eight years has been much slower than in the rest of the world (see the previous section), effectively stagnating over the period (for further discussion on this, see section 3.2.2).

In 2015/16, UK feedstocks accounted for 24% of the biofuel production, mainly consisting of wheat for bioethanol and used cooking oil (UCO) for biodiesel (Figure 2). The main imported biofuels/feedstocks were corn, sugar beet and wheat ethanol, and UCO<sup>[1]</sup>. The UK Department for Environment, Farming and Rural Affairs (DEFRA) estimates that, in 2015/16, a total of 93,000 hectares (ha) of agricultural land was used for bioenergy in the UK<sup>[22]</sup>, most of which was for wheat (41,000 ha) and corn (34,000 ha) production, with the rest planted with sugar beet (9,000 ha), Miscanthus (7,000 ha), short rotation coppice (3,000 ha) and rapeseed (300 ha)<sup>iv</sup>. Of the total, 53% (49,000 ha) was

iv Since these crop areas are derived from the amount of fuel supplied to UK road transport, they do not account for any UK grown crops that are processed into biofuels and then exported (and not re-imported), that are supplied to markets other than road transport or are exported to be processed into biofuels elsewhere.



**Figure 1**  
Supply of biofuels in the UK by fuel type [based on data from <sup>[1]</sup>]

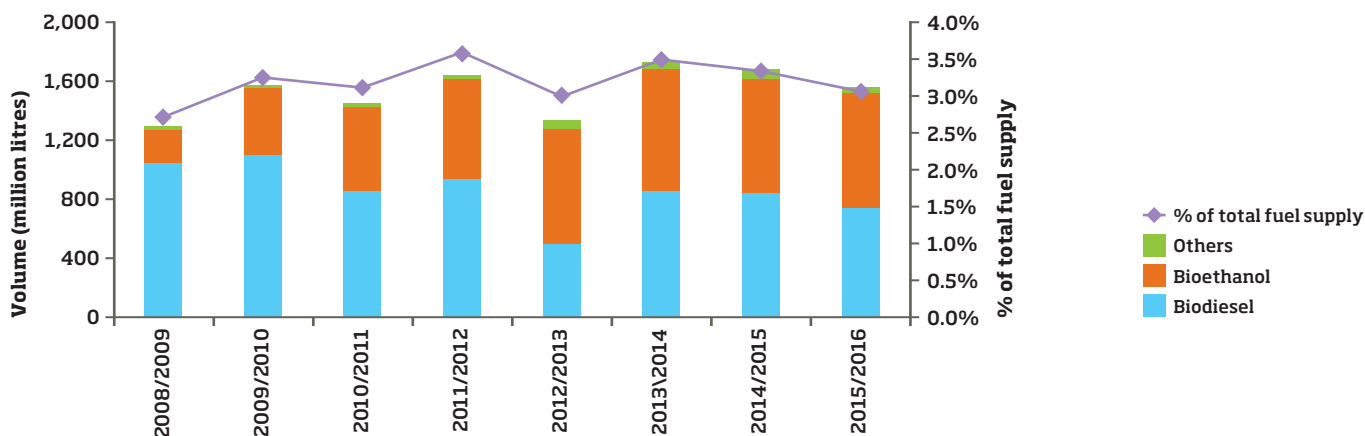

designated for biofuel feedstocks for the UK road transport market, amounting to 0.8% of total arable area in the UK. This was equivalent to approximately one million tonnes of UK crops for the UK road transport market in 2015, a decrease of 17% compared to production in 2014/15.

Currently, there are no biofuels in the UK derived from lignocellulosic feedstocks. While there is some cultivation of energy crops, used largely for power generation, the planted area is small; this includes both established perennial crops, such as *Miscanthus* and short rotation coppice (SRC) willow and novel species, like switchgrass and reed canary grass<sup>[23]</sup>.

On the other hand, the expansion of waste feedstocks has been much more successful, largely driven by the double-counting mechanism. This has been particularly effective for UCO, with supplies in the UK being sourced from more than 50 countries. The top suppliers in 2015/16 were Spain, USA, Germany, the Netherlands, Saudi Arabia, UAE, Taiwan and France, respectively. Currently, 57% of biofuel supplied in the UK (meeting RED criteria) is produced from a waste/non-agricultural residue feedstock and is eligible for double counting<sup>[1]</sup>. However, it should be borne in mind that long-range transport of imported feedstocks leads to additional GHG and other emissions, particularly those from shipping, including sulphur dioxide (SO<sub>2</sub>), nitrogen oxides (NO<sub>x</sub>) and particulate matter.

For example, transport of feedstocks or biofuels over a distance of 10,000 km can contribute 7% to 38% to the total carbon footprint of biofuels<sup>[24,25]</sup>.

Table 2 provides information on the nine largest UK biofuel plants, most using wheat, UCO and other waste. In addition to these large-scale production plants, there are a number of significantly smaller operations producing biodiesel from UCO, typically ranging from a few thousand to a million litres of biofuel production per year. As can be seen in Table 2, the UK industry is dominated by the large-scale operators. This is partly because smaller producers struggle to sell RTFCs directly to obligated fuel suppliers as the number of RTFCs that they can supply is too low to generate interest from large suppliers<sup>[26]</sup>. Smaller suppliers also typically do not have significant resources to handle complex certificate trading or price forecasting and their cash-flow position pushes them to sell their certificates as soon as possible, even if selling at a later stage could achieve a better price<sup>[26]</sup>. These points were confirmed during our stakeholder consultation.

Shipping, aviation and heavy goods vehicles (HGVs) have fewer options for low-carbon fuels compared to passenger road transport and analyses of the future energy system suggest that they should be considered a priority for the development and use of biofuels<sup>v</sup>. However, while progress has been made on increasing

**Table 2**  
Large commercial biofuel plants operational in the UK (updated based on information from<sup>[26]</sup>)

Company	Location	Capacity (million litres/year)	Fuel type	Current feedstock mix
Argent Energy	Motherwell, Scotland	60	Biodiesel	Used cooking oil, tallow, sewerage grease
Argent Energy	Stanlow, Ellesmere Port	85	Biodiesel	Used cooking oil, tallow, sewerage grease
Greenenergy	Seal Sands, Teesside	284	Biodiesel	Primarily waste oils
British Sugar	Wissington, Norfolk	70	Bioethanol	Sugar beet
Convert 2 Green	Middlewich, Cheshire	20	Biodiesel	Used cooking oil
Greenenergy	Immingham, Hull	220	Biodiesel	Waste oils
Ensus	Wilton, Teesside	400	Bioethanol	Wheat
Olleco	Bootle, Merseyside	16	Biodiesel	Used cooking oil
Vivergo	Immington, Hull	420	Bioethanol	Wheat



**Figure 2**  
Supply of biofuels in the UK by feedstock type [data from <sup>[1]</sup>]

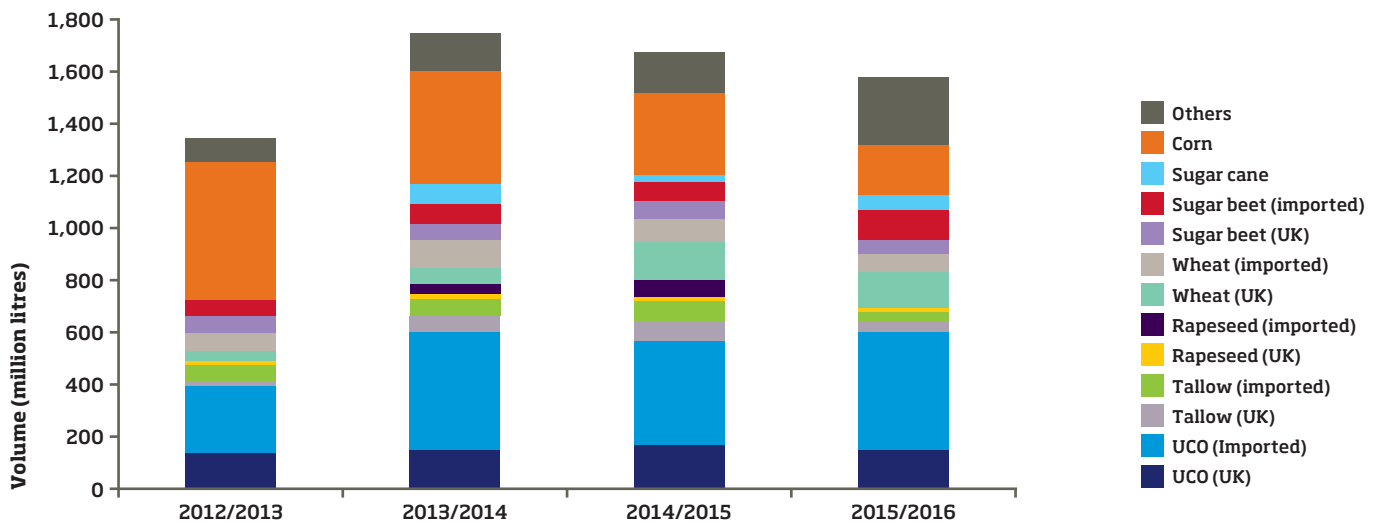

the contribution of biofuels to road transport in the UK (to 4.75% by volume under the RTFO), less, if any, progress has been made in aviation and shipping. The main constraint in aviation is the need for fungible fuels that meet the sector's high performance specifications. Production via hydrogenated vegetable oils is currently technically feasible but not cost competitive, requiring further development. Incentives for this are currently stronger in the US than they are in Europe. It should also be borne in mind that fuel weight per unit of energy is a critical factor in aircraft performance and operation. Biofuels are at a disadvantage as they have lower calorific value per unit volume than fossil fuels. This means that aircrafts must carry significantly more fuel, which reduces their efficiency and may require design changes.

Shipping is considerably more 'omnivorous' in terms of fuel specifications; however, biofuels are currently not used for marine shipping in the UK <sup>[30]</sup>. The price, availability and speed of loading are the key factors that determine choice of fuel for ships. Other key technical challenges are the need to store fuel on board ships for long periods of time and the range of environmental conditions in which critical equipment must operate. The storage of biofuels for long periods can cause hydrolysis of the fuel and subsequent corrosion, ingress of water and microbial growth <sup>[30]</sup>. Sustainability standards are currently not a significant driver of fuel quality; the ISO 8217 standard on Marine Fuel Specification currently precludes the use of biodiesel as a marine fuel (although a revision to this is expected). In addition, the governance of shipping is international and highly complex. There may, however, be some scope to extend governance mechanisms, such as the MARPOL International Convention for the Prevention of Pollution from Ships, which currently covers sulphur emissions and energy-efficient ship design.

HGVs are generally powered by diesel engines and this is likely to continue for the foreseeable future. As with passenger car manufacturers, there is a general acceptance of B7 blend (7% of biofuel by volume added to conventional diesel) in the HGV sector <sup>[30]</sup>. Although there is a standard in the US for blends up to B20 (ASTM D7467 <sup>[31]</sup>), early trials of blends at this level showed various difficulties, including possible incompatibility with some engine materials present in the fleet, higher engine

component wear, higher dilution rate of lubrication oil than for standard ultra-low-sulphur diesel, negative effects on particulate filter regeneration and a fuel consumption penalty. The latter is particularly significant as fuel costs dominate heavy duty vehicle operating costs. There have also been concerns from fuel injection manufacturers owing to concerns regarding viscosity, density, lubrication and compatibility of materials. Effects are also dependent on climatic conditions and the vehicle operating cycle; for example, long distance haulage versus inner city buses and refuse trucks. As a consequence, use of high blends would require engine modifications. For that reason, operators have generally been conservative over the introduction of biofuels. Work has been ongoing to understand the mechanisms involved and to ameliorate negative effects <sup>[32-34]</sup>. Successful trials <sup>[35]</sup> have led to the use of B20/B30 for return-to-base vehicles, whereby the fuel quality may be maintained and vehicle compatibility is known (manufacturers quote a maximum blend percentage in their warranties).

More progress has been made in the aviation sector - where some active supply chains currently exist - than in shipping and HGVs. This has been driven by the introduction of some regional sustainability requirements and airlines' desire to achieve globally harmonised standards. Aviation also receives more consumer and public attention on environmental issues.

## 3.2. Future supply

### 3.2.1. Global production

Several international and national organisations have made mid- and long-term projections of the global production of biofuels. These projections provide wide-ranging estimates on future increase in liquid biofuels for transport globally. Some estimate that as much as one-third of all transportation fuel by 2050 could come from biofuels, while others predict more modest increases. For example, the International Energy Agency (IEA) 'technology roadmap' on transport biofuels suggests that biofuels might constitute around 27% of global transport fuel supply in 2050 <sup>[36]</sup>. This projection is based on several assumptions that are optimistic

v For example, analysis by the Committee on Climate Change <sup>[27,28]</sup> shows that the only options available for reduced emissions from aviation are measures on fuel efficiency, operational efficiency, modal shifts, constraints on demand and use of biofuels. For shipping, measures include use of larger ships, improved fuel efficiency through technology and operational innovations and the use of either biofuels or liquefied natural gas (LNG). For biofuels, the main constraint cited is availability while, for LNG, there are practical constraints on use related to low energy density, lack of refuelling infrastructure and limited emissions reduction potential relative to conventional fuel. For HGV, see, for example, the roadmap produced by Ricardo <sup>[29]</sup>.

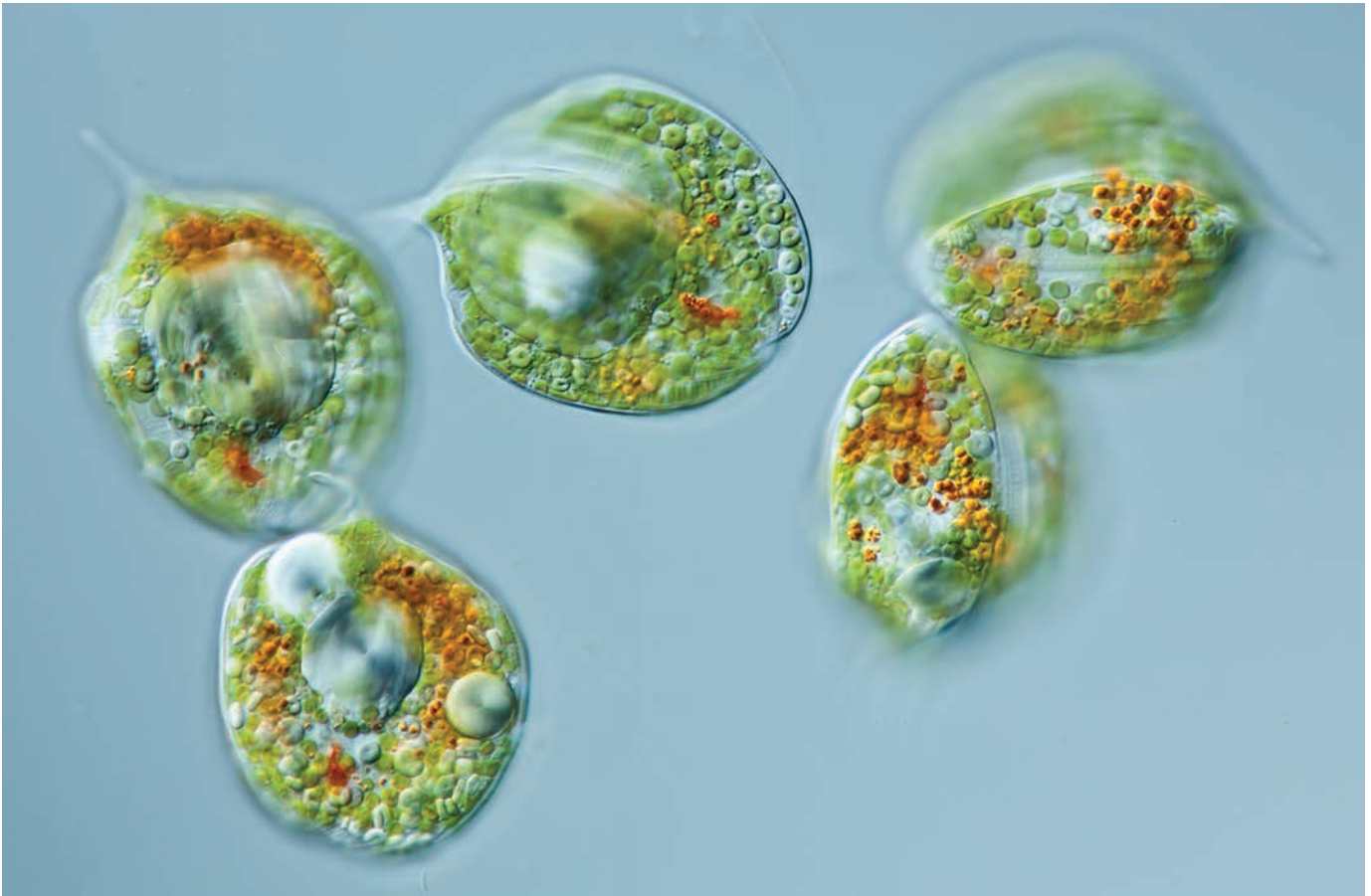

Microalgae

and contentious. For instance, it assumes that the majority of production will come from second generation feedstocks grown on marginal lands that are not suitable for food crop production. It also assumes that microalgae biodiesel will be commercially available by the year 2030 – a claim that was disputed by a number of stakeholders consulted as part of this study. A recent assessment<sup>[37]</sup> also suggests that the IEA projections could be impossible to achieve, estimating the maximum potential of transport biofuels by 2050 to be at least 30% lower than those projected by IEA. Other organisations, such as the OECD and BP, project approximately a 7% share of biofuels by 2030<sup>[44]</sup>.

It should also be noted that the global context for biofuels is changing owing to the volatile crude oil prices [38]. Lower oil prices since 2014 have resulted in a more challenging investment climate for biofuels. However, with blending mandates driven by the need to decarbonise, biofuels production is expected to rise, albeit slowly, reaching almost 4.3% of world road transport fuel in 2020 [38]. Although the impact of a prolonged low oil price on the demand for biofuels has not been evaluated, a review of the available studies<sup>[44]</sup> concludes that a contribution of 7% to total transportation fuels by 2030 appears reasonable since biofuels already contribute around 4%.

There are some developments that suggest demand for bioethanol might increase significantly more than for biodiesel. The diesel engine, and diesel cars in particular, have been under increasing scrutiny owing to manipulation of the emissions homologation<sup>vi</sup> process by some car manufacturers and the failure to replicate expected NOx emissions in real driving conditions. Actual

measurements have indicated that average tailpipe NOx emissions from diesel cars are seven times the certified emission limit for Euro 6 vehicles<sup>[39]</sup>. This issue is causing significant concern, particularly in urban conditions, where air quality issues and related human health impacts are receiving increasing political attention<sup>[40,41]</sup>. Diesel technology is also under pressure from the progressive introduction of direct injection in petrol engines (approximately 50% of sales), which improves fuel consumption but maintains emissions performance<sup>[42]</sup>. Finally, bioethanol is a comparatively consistent product while biodiesel can have variable properties that limit high blends in general use. For biodiesel, B7 blends are typical, whereas E10 bioethanol blends are practical for the great majority of UK petrol cars and have already been introduced in other countries. It is also possible to engineer petrol engines to use higher blends, including E85 and E100. For example, there have been significant sales of such vehicles in Sweden, stimulated by government incentives and provision of new filling stations. While favourable climatic conditions have been an enabling factor<sup>vii</sup>, Brazil has used E100 for some time and has a significant fleet. On the other hand, there are no offerings of high-blend biodiesel cars thus far. With the increasing tolerance of petrol cars to higher blends of bioethanol and the penetration of direct injection technology, it is likely that petrol vehicles will have superior carbon emissions on a well-to-wheel basis<sup>[44]</sup>.

With respect to algae, although numerous large-scale, commercial cultivation, harvesting and processing facilities exist around the world, most are used for the production of high-value food

vi The term used for emissions testing for compliance with standards in the automotive industry.

vii The cold starting of engines is affected since ethanol evaporates at a higher temperature (has a lower vapour pressure) than petrol. This is not a significant issue in Brazil because of its warm climate. However, in Sweden, for example, ethanol blends are lowered during winter (from E85 to E70) as a response to the lower temperatures<sup>[43]</sup>.



Used cooking oil at recycling centre

additives rather than for low-cost transportation fuels<sup>[45]</sup>. Also, many new technologies for extraction and separation of algal oils and the transformation of those oils into biodiesel are unproven at a commercial scale. Algae production using wastewater and waste CO<sub>2</sub> sources has received special attention. So far, however, algal pathways are considered theoretical rather than mature, and transformative breakthroughs are needed to make algal biodiesel viable both economically and energetically<sup>[45]</sup>. The integrated biorefinery concept could help overcome these challenges by producing high-value products along with biofuels<sup>[46]</sup>. However, the disparity in the size of the biofuels market compared to the market for high-value products is an issue<sup>[47]</sup>. As such, both our national and international stakeholder consultation suggested that algae production would remain restricted to high-value products, such as cosmetics, dietary supplements or speciality chemicals.

### 3.2.2. Supply in the UK

As mentioned earlier, the production of biofuels in the UK has been stagnating over the past eight years. This is largely due to the level of biofuels supply being limited by the RTFO, currently at 4.75% by volume. Producers have no policy or market incentives to produce above this amount and there has been significant loss of investor confidence since expected rises in the RTFO have not been introduced. This has led to many plants running below installed capacity and many UK investments to be written off. What investments there have been since 2013 have largely focused on retrofitting first generation plants to process a broader range of feedstocks - particularly converting vegetable oil biodiesel plants

to run on waste fats and oils, with several plants transitioning completely to UCO or tallow. A £25 million competition to demonstrate 'advanced' (second or third generation) biofuels and encourage scale up from pilot to commercial scale was announced by the UK Department for Transport (DfT) in 2015, with three winning projects<sup>[48]</sup>. Further funding of £20 million was announced in late 2016, targeting the decarbonisation of HGVs and aviation<sup>[49]</sup>. However, any significant uplift in UK production is highly dependent on a stable trajectory for increasing the blending obligation or a similarly strong incentive and high investor confidence in such policy signals.

Notwithstanding this, both existing studies and input from producers consulted in this study indicate that there is sufficient feedstock availability to meet any foreseeable uplift in blending obligations to meet the current RED target. The UK Bioenergy Strategy<sup>[50]</sup> indicates that sustainably sourced bioenergy (as defined by the RED criteria) could contribute around 12% by 2050 to the UK's total primary energy demand (within a range of 8% to 21%). However, international supplies, particularly from North America, will be a key contributor to this deployment so this potential increase in biofuels supply would partly depend on the levels of domestic demand in other countries.

A recent report<sup>[51]</sup> estimates that the accessible<sup>viii</sup> biomass feedstock in the UK could provide 580 PJ to 670 PJ in 2030 or 7% to 8% of the UK's primary energy demand (based on UK energy demand of 8480 PJ in 2015). In terms of availability of second generation biofuel feedstocks, the available analysis suggests

viii The accessible biomass resource is defined in the report as a resource available after price-independent competing uses have been subtracted from the total potential resources<sup>[51]</sup>.



## THE NATIONAL NON-FOOD CROPS CENTRE (NNFCC) ESTIMATES THAT THE UK HAS NEARLY 16 MILLION TONNES OF DOMESTIC CROP WASTES, FOREST RESIDUES AND OTHER WASTE MATERIALS. THE GREATEST CONTRIBUTIONS ARE FROM GREEN WASTE (31%), AGRICULTURAL STRAW (25%) AND WASTE PAPER (27%); THE LATTER IS CURRENTLY COLLECTED AND EXPORTED.

that, if all the wastes and residues that are sustainably available in the EU were converted only to biofuels, this could supply 16% of road transport fuel in 2030<sup>[52]</sup>. However, these feedstocks have other competing uses, such as production of heat and power and production of biochemicals<sup>[53]</sup>.

Although at present no biofuels supplied in the UK are derived from lignocellulosic feedstocks, it is expected that future sustainability requirements will become more stringent. This is likely to drive a shift towards lignocellulosic feedstocks or waste for biofuel production, provided the technological challenges for these types of feedstock can be overcome<sup>[54]</sup>, together with reducing production costs. In the regions where they are currently cheapest, some feedstocks, such as agricultural and forest residues and municipal solid waste, are close to being competitive without incentives<sup>[52]</sup>.

The National Non-Food Crops Centre (NNFCC) estimates that the UK has nearly 16 million tonnes of domestic crop wastes, forest residues and other waste materials<sup>[55]</sup>. The greatest contributions are from green waste (31%), agricultural straw (25%) and waste paper (27%); the latter is currently collected and exported. The availability of this biomass varies significantly by region and by type, with most of it arising in the Eastern and Southern regions of England. Scotland has the highest potential availability of forest residues and a considerable amount of collected green waste. Feedstocks with the most reliable year-round supply are likely to be green waste, paper waste and forest residues, but could have varying composition over time. Straw and energy crops are likely to provide the most consistent composition, but year-round supply requires storage of seasonal harvests. However, many alternative uses exist for these feedstocks that may compete with their use as biofuel feedstocks, including power generation, composting media, or use for livestock bedding.

The NNFCC has also analysed the potential for non-food crops grown specifically for energy generation in the UK<sup>[23]</sup>. This included both established perennial crops, such as *Miscanthus* and short rotation coppice (SRC) willow, and novel species such as switchgrass and reed canary grass. The theoretical maximum area of land available in England and Wales for growing *Miscanthus* and SRC,

not impinging on food production, was found to be between 0.93 and 3.63 Mha. However, in reality, planting will not take place below a certain gross margin. Assuming a gross margin of £241/ha for SRC<sup>ix</sup> (at £60 per oven dry tonne (odt)), this figure decreases to 0.62 to 2.43 Mha. *Miscanthus* can attain higher gross margins than SRC owing to higher productivity. Assuming planting would not take place below a gross margin of £526/ha for *Miscanthus*<sup>x</sup> (at £60/odt), the maximum area of land available would be 0.72 to 2.80 Mha. Despite these margins being available to some growers in the current market, nothing approaching this level of uptake has occurred yet, leading the NNFCC to conclude that education, training and improved contract security are required<sup>[23]</sup>. Business as usual would mean that perennial energy crops would continue to play a marginal role.

E4Tech<sup>[56]</sup> has specifically assessed the potential for establishing lignocellulosic biorefineries in the UK. The authors argue that establishment of lignocellulosic biorefineries requires available and sustainable feedstocks, viable business models across the entire supply chain, suitable locations with potential for business clustering and downstream users, as well as a supportive policy framework. They analysed four feedstock-specific scenarios for UK biorefineries and found the following:

- Co-location of a biorefinery with a biomass power station is appealing owing to the existing feedstock supply chains, potential scale of operation and integration with existing power generation activities. Commercial competitiveness will depend on feedstock costs and this option is currently technically challenging as wood pellet conversion is less mature than, for example, straw.
- Conversion technologies for straw are comparatively mature and relatively low cost but supply potential<sup>xi</sup> may be a limiting factor in the UK, although there is a lignocellulosic ethanol plant in the design phase. There is existing supply chain experience with straw for power generation, which can be drawn upon to identify regional concentrations of feedstock in the UK.
- Producing bio-based products from municipal solid waste (MSW) is a favourable option with respect to feedstock costs, waste

ix This margin was derived from the fact that SRC currently achieves between £45–60/odt on energy crop contracts with power stations, which would deliver a gross margin of between £116/ha and £241/ha, respectively, based on 8.3 odt/ha.

x This takes £60/odt as a typical contract price, which can be as low as £45/odt and as high as £75/odt.

xi Based on the scenario focusing on Eastern England, the region with the highest straw availability in the UK. Straw is mainly derived from wheat grown in the region and, to a smaller extent, from barley, oil seed rape and oats. However, uncollected straw is currently chopped and incorporated back into the soil, improving soil quality, so only a fraction would be available and the farmers' willingness to provide it may vary<sup>[56]</sup>.

policy and other sustainability objectives. However, it depends on the identification of sites with available and accessible feedstock that is not already contracted to a competing use. A demonstration plant could give the UK a competitive edge in Europe. The US already has a commercial facility producing bioethanol from MSW mixed with woody waste<sup>[57]</sup>.

- A biorefinery based on perennial crops could secure a dedicated feedstock, but only if farmers can be engaged to grow the crops; a significant challenge is establishing such dedicated supply chains and would potentially involve issues with land-use change.

Generally, E4Tech also concludes that developing low-carbon lignocellulosic biofuels will open broader opportunities for producing renewable chemicals and materials that enable a circular economy and are more sustainable than fossil-based products, presenting significant scope for innovation that uses existing UK strengths in lab and pilot-scale research<sup>[56]</sup>.

When considering future production of biofuels, it is also important to place it within the context of the whole energy system in the UK, as the choice of fuels for transport will be affected by the fast-developing energy scene during the next few years. For example, the rapid growth of wind-turbine installations in the UK could result in transient surplus electricity that might then be used for water electrolysis to produce hydrogen, a competing source of low-carbon fuel. Alternatively, hydrogen could continue to be produced by steam methane reforming but with the addition of carbon capture and storage. Furthermore, biomass is already a subject of competition from a range of applications that is expected to increase in the future. This includes electricity and heat generation, which represent a more efficient use of biomass than its conversion to liquid transport fuels. However, greater use of gas-powered combined heat and power, which is more efficient than individual gas boilers and power stations, could release more biomass for liquid biofuel production. This is particularly relevant as energy needed to heat buildings in the UK is approximately equal to the energy needed for road transport<sup>[58]</sup>. These examples highlight the fact that liquid biofuels and related policy must be integrated into the overall energy landscape and cannot be considered in isolation.

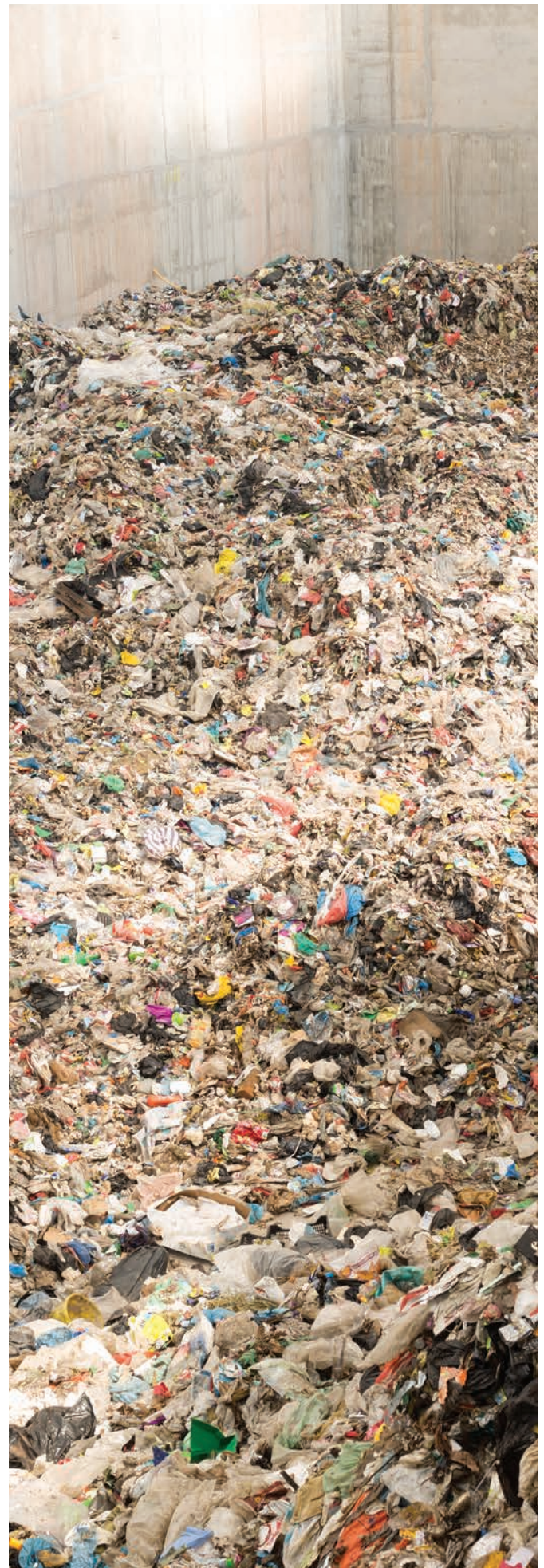

Municipal solid waste





Bioethanol production

# 4.

## Key sustainability issues associated with liquid biofuels

Biofuels offer both advantages and pose risks in terms of environmental, economic and social sustainability<sup>[59]</sup>. On the one hand, reduction of GHG emissions, energy security and rural development are the most important drivers for biofuels globally. On the other hand, there are concerns related to the increasing production of biofuels, such as upward pressure on food prices, the risk of increase in GHG emissions through direct and indirect land use change (LUC) from production of biofuel feedstocks, as well as the risks of degradation of land, forests, water resources and ecosystems. The use of first generation feedstocks, such as corn, has become a particularly contentious issue, largely owing to competition with food production and concerns over diverting agricultural land into fuel production. A growing demand for agricultural produce risks an increase in deforestation and use of land with a high biodiversity value to meet this demand, as well as associated usage of freshwater, fertilisers and pesticides, with negative consequences on the environment. Some of these issues could be addressed by using second generation feedstocks; however, the economic viability of some second generation of biofuels remains doubtful in the current economic context, largely because of the low oil prices<sup>[60-62]</sup>.

Third generation (algal) biofuels could also avoid the issue of food competition and land use because microalgae can be grown on non-arable land and in wastewater, saline or brackish water and they grow extremely rapidly. However, the production of biofuels from microalgae is energy intensive and remains economically unviable<sup>[45]</sup>.

Figure 3 depicts the sustainability aspects of biofuel production and use considered in the study. The primary focus in this report is on the carbon footprint of biofuels; however, consideration is given to other environmental, economic and social aspects covered in the studies reviewed and raised during stakeholder consultation. Prior to discussing the findings, the following sections give an overview of how the sustainability of biofuels can be evaluated and certified.

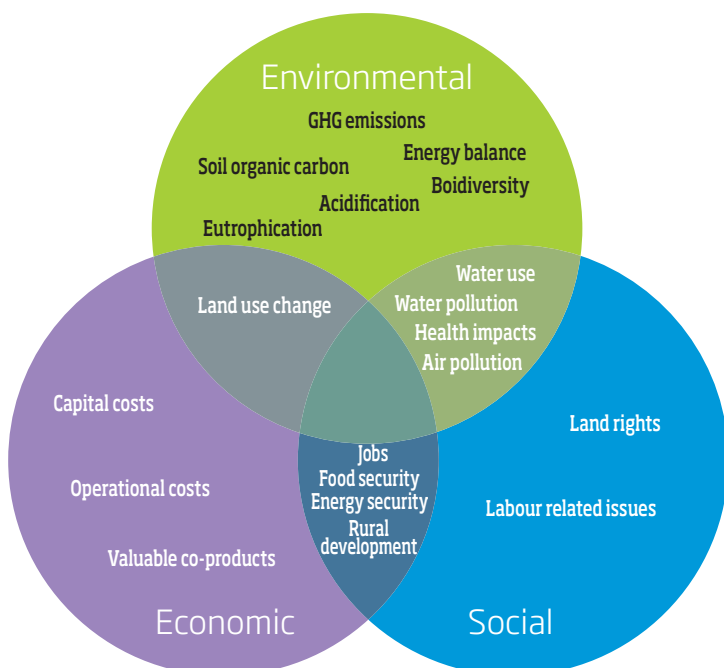

**Figure 3**  
Sustainability aspects of biofuels considered in the study

The categorisation of different issues as environmental, economic or social is based on their primary impact. For example, GHG emissions cause climate change, which has environmental, economic and social implications. Most sustainability issues also straddle two or all three dimensions of sustainability.





Soybean field

# 5.

## Methods, standards and certification schemes for assessing sustainability of biofuels

### 5.1. Life cycle assessment (LCA)

LCA is a method used to quantify environmental impacts of products, technologies or services on a life-cycle basis. Depending on the goal and scope, an LCA study can be from 'cradle to grave' or from 'cradle to gate'. For example, a cradle-to-grave LCA study of a product considers all life cycle stages from extraction of raw materials and fuels ('cradle') through production and use of the product to its final disposal as waste ('grave'). By contrast, 'cradle to gate' does not follow the product to the use stage but stops at the factory 'gate' where the product has been produced.

LCA has been used widely in industry and by policymakers. Example applications include evaluation of environmental sustainability of products and technologies, comparisons of alternative production systems, identification of environmental 'hotspots' and improvement opportunities. In the case of biofuels, LCA has had significant influence on the development and implementation of policies and regulations in Europe and the USA.

#### 5.1.1. Type of LCA approach: attributional vs. consequential

LCA approaches can be classified as attributional (ALCA) or consequential (CLCA). ALCA accounts for impacts directly related to the system of interest, attributing them to the activities within the system (hence the term 'attributional'). For example, ALCA of biofuels attributes estimated life cycle environmental impacts to various activities in the supply chain, including cultivation of feedstocks and production and use of biofuels. CLCA, in addition to direct, also examines potential indirect consequences of the system under study by considering various 'what if' scenarios that could arise owing to this system; examples include changes in demand for the product of interest or technological improvements. For instance, CLCA can consider potential impacts of biofuel feedstock cultivation on other land-using sectors and the effect this might have on the food production system and LUC elsewhere in the global economy<sup>[63,64]</sup>. [Table 3](#) provides an overview of the key differences between ALCA and CLCA.

ALCA has been used mainly as an 'accounting' tool for estimating environmental impacts of different systems, comparisons of alternative systems and identification of environmental 'hotspots' that can be targeted for improvements. By contrast, CLCA is not

**Table 3**  
Key differences between attributional and consequential LCA approaches [adapted from <sup>[69]</sup>]

Aspect	ALCA approach	CLCA approach
Goal of the study	To assess environmental impacts of the system of interest	To determine potential environmental consequences of the system of interest on related systems, considering economy-wide consequences
System boundary	Flows into, within and out of the system directly related to the system of interest. System boundary of the system of interest does not overlap with other systems	As ALCA, plus flows that are indirectly affected by a marginal (unit) change in the output of a product (eg. through market effects, substitution, use of constrained resources, etc.). System boundary of the system of interest overlaps with other systems
Type of question (example)	What are the total impacts from the production of a unit of the product of interest?	What are the environmental consequences on different production systems of producing one additional unit of the product of interest?
Perspective	Current/Future	Future
Approach	Calculates impacts directly related to the system of interest, using life cycle inventory data.	Life cycle inventory data combined with economic models to predict both direct and indirect effects on markets
Treatment of co-products (allocation)	System expansion or allocation (eg. mass, energy, economic value)	System expansion, including market-related effects
Data	Marginal and average data	Marginal data with historical and future projections
Indirect effects	Not considered	Includes different indirect effects, such as interactions with existing policies
Market effects of production and consumption	Not considered	Considered
Uncertainty	Relatively low	High

appropriate as an accounting tool but is more suited for policy applications. For example, the US Environmental Protection Agency (EPA) has used partial equilibrium models to estimate the overall ILUC associated with the biofuel scenario mandated by the Energy Independence and Security Act of 2007<sup>[65]</sup>. However, the use of CLCA for policy is still in infancy and its application to biofuels is controversial and subject to criticism<sup>[66,67]</sup>. One of the main reasons is that consequential analysis is highly complex, being dependent on future projections, formulation of possible 'what if' scenarios and counterfactual circumstances, economic models of relationships between demand for inputs, price elasticities, supply and markets effects of co-products, all of which can be highly uncertain<sup>[63,68,69]</sup>. Therefore, caution should be exercised with the interpretation of CLCA results<sup>[69]</sup>. Furthermore, unlike ALCA, there is still no internationally agreed methodology for CLCA, making it difficult to carry out and compare different studies.

It should be noted that ALCA and CLCA cannot be compared - neither is 'better' or 'more detailed'; they are different techniques developed to address different questions. They, therefore, follow different methodologies and will normally provide very different results that must be interpreted carefully based on the goal and scope of the study. For example, Searchinger et al.<sup>[70]</sup> found that using ALCA results in a 20% saving in GHG emissions from US corn ethanol compared to petrol. However, following a CLCA approach and considering the increase in output required by the US Energy Independence and Security Act leads to a 47% increase in emissions relative to petrol. This increase was related to LUC induced by higher prices of corn, soybean and other grains as a consequence of the additional demand for corn for ethanol production.

### 5.1.2. LCA standards

The methodology for ALCA is standardised by the ISO 14040 and 14044 standards<sup>[71,72]</sup>. It comprises four phases: goal and scope definition, inventory analysis, life cycle impact assessment and interpretation (see Figure 4). The ISO standards provide only generic guidelines, leaving the individual practitioner with a range of choices, which often makes comparisons of LCA studies difficult. Moreover, the ISO standards do not provide detailed instructions on how to address critical issues that typically occur when conducting an LCA of biofuels, such as the impacts of LUC associated with biomass production (see section 6.4.) or accounting for biogenic carbon (see section 6.5.).

### 5.1.3. Greenhouse gas (GHG) standards

The drive to mitigate climate change has brought special attention to the GHG emissions in the life cycle of products. Over the last years, several standards, calculation methods and approaches for assessing GHG emissions have been proposed and are being used at the product level. The widely used standards are Publicly Available Specifications (PAS) 2050<sup>[73]</sup>, GHG Protocol - Product Life Cycle Accounting and Reporting Standard<sup>[74]</sup> and ISO 14067<sup>[75]</sup>.

These standards are based on the LCA methodology established by ISO 14040 and 14044<sup>[71,72]</sup> and therefore follow the attributional approach (note also that the approach used in the RED and RTFO is also largely consistent with ALCA). They provide requirements and guidelines for several common methodological issues, such as goal and scope definition and allocation, as well as more specific issues, including land-use change, biogenic carbon emissions, soil carbon change, carbon storage in products and delayed emissions.

**Figure 4**  
The methodological framework for life cycle assessment according to the ISO 14040/14044 standards [71,72]

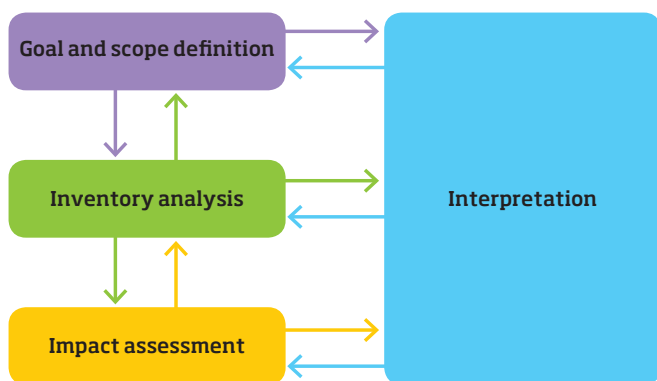

ISO 14067 is a general standard while PAS 2050 and GHG Protocol provide more detailed requirements and guidance with less room for interpretation. However, ISO 14067 provides more detailed guidelines for communicating carbon footprints of products through labelling, declarations and performance reports. PAS 2050, developed in the UK and first published in 2008 and revised in 2011, was one of the first carbon footprinting standards internationally. The revised version is in alignment with the GHG Protocol on key topics, such as biogenic carbon, recycling, LUC and delayed carbon emissions.

## 5.2. Sustainability standards

Published in 2015, the ISO 13065 standard on *Sustainability Criteria for Bioenergy*<sup>[76]</sup> provides a framework for evaluation of environmental, social and economic sustainability of different bioenergy products and supply chains, including biofuels. It specifies a set of principles, criteria and indicators that should be used in sustainability assessments. The standard deals only with direct impacts, defined as those that are “under the direct control of the economic operator and caused by the process being assessed”. Therefore, indirect impacts are outside the scope of the standard. Furthermore, the standard does not follow a life cycle approach. The only exceptions to this are GHG emissions and energy use, which must be estimated on a life cycle basis in accordance with the ISO 14067 and ISO 14040/44 standards. However, while the standard does not mandate a life cycle approach for the other indicators, it

provides the operator with the flexibility to express environmental impacts over the life cycle of the product considered.

The key principles considered in ISO 13065 are listed in Table 4. For most environmental principles, the criteria and indicators generally follow a common format, setting out requirements for describing the procedures applied to identify potential impacts; listing impacts identified; describing measures taken to address impacts; and reporting the relevant values and trends of key parameters or metrics used to measure the effects of addressing the impacts identified. The criteria and indicators associated with the principles on social sustainability specify requirements on describing relevant policies, procedures and practices that safeguard against infringements on relevant human rights as well as providing some specific indicators. For example, indicators for the criterion on child labour includes the number of workers defined as children in accordance with the applicable law and the form of the work performed (regular or light)<sup>[76]</sup>. Finally, the economic principle includes the criteria for the provision of information on procedures, parameters, assessments and metrics on fraudulent, deceptive or dishonest commercial business and consumer practices as well as on financial risk management.

## 5.3. Certification schemes

Various voluntary sustainability certification schemes have been developed for application by biofuels producers within their supply chains. The European Commission currently recognises

**Table 4**  
Sustainability principles considered in ISO 13065 [76]

Environmental	Social	Economic
Reduce life cycle anthropogenic GHG emissions	Respect human rights	Produce and trade bioenergy in an economically and financially viable way
Conserve and protect water resources	Respect labour rights	
Protect soil quality and productivity	Respect land use rights	
Promote good air quality	Respect water use rights	
Promote positive and reduce negative impacts on biodiversity		
Promote efficient use of energy resources		
Promote responsible management of waste		



## COMPLIANCE-BASED SCHEMES ARE WEAKER ON SOCIAL ISSUES AND TEND NOT TO INCLUDE STAKEHOLDER ENGAGEMENT, WHILE THOSE WITH A BROADER REMIT REQUIRE MULTI-STAKEHOLDER ENGAGEMENT THROUGH ALL STAGES OF STANDARD-SETTING, IMPLEMENTATION AND FURTHER DEVELOPMENT.

19 voluntary certification schemes as meeting the requirements under the RED and can be used to certify biofuels. This recognition is based on an assessment by the Commission that is valid for five years, after which schemes must be reassessed<sup>[5]</sup>. All 19 schemes implement RED mandatory minimum requirements. However, schemes vary significantly in intention, geographical coverage, scope, organisation and governance and can apply both stricter and additional criteria beyond the RED. As a consequence, some schemes are compliance based, covering RED requirements only, while others consider more comprehensive sets of environmental and social criteria.

National systems require and accept the certificates issued under the voluntary schemes recognised by the Commission as proof of sustainability and usually several schemes operate in each EU member state. Voluntary schemes are established mostly by privately run entities. Many have been developed by groups of economic operators and other interested parties, such as consortia or 'roundtables'. There are also schemes developed by biofuel producers. In the UK, the International Sustainability and Carbon Certification (ISCC) is the dominant scheme, being used to certify 89% of biofuels supplied in the UK during 2015/16<sup>[21]</sup>.

Schemes rely on independent auditors, who certify compliance by economic operators on behalf of a scheme, according to contracts with that scheme. Auditors from the certification bodies may also carry out documentary and on-the-spot checks on farmers, first biomass collection points, warehouses, oil mills, biofuels plants and biomass or biofuels traders. The operator producing biomass or biofuels pays certification costs to the certification body and fees to the voluntary scheme from which they obtain certification. Every economic operator in the chain of cultivation and conversion has to provide purchasers of biomass or biofuels with information about the sustainability characteristics of the products it delivers and their certification. The recognised voluntary schemes certify biomass produced in the EU and also imported into the EU.

Soon after the EU approved the first seven voluntary schemes in July 2011, concerns were raised about a lack of social considerations; two of the seven schemes initially approved had no commitments to social sustainability<sup>[77]</sup>. Most recently, the 19 schemes currently approved by the EU have been assessed by the European Court of Auditors (ECA), considering whether the Commission and member states have set up a reliable certification system for sustainable biofuels<sup>[5]</sup>. The actual schemes and related certification bodies do not benefit from any EU expenditure and thus could not be subject to audit by the ECA. Therefore, the audit, conducted between May

and November 2015, did not directly cover schemes and scheme operators, although some scheme operators were visited by the Court's auditors, including in the UK. Instead, the main focus of the audit was the Commission's process of scheme assessment and recognition, as well as the quality of the data the Commission receives.

The Commission's assessments of voluntary schemes, which are carried out by an external contractor on behalf of the Commission, only assess the RED mandatory sustainability criteria. Therefore, the ECA concluded that the other important aspects necessary to ensure the sustainability of biofuels were not assessed and that the recognition process should be expanded. The audit also concluded that weaknesses in the Commission's recognition procedure and subsequent supervision of voluntary schemes meant that the EU certification system is not fully reliable. In particular, the ECA highlighted the following:

- There was no requirement to verify that biofuel production did not cause significant risks of negative socio-economic effects such as land-tenure conflicts, forced or child labour, poor working conditions for farmers and dangers to health and safety.
- The impact of ILUC on sustainability was not covered; although the ECA acknowledged the technical difficulties in assessing this, it concluded that the relevance of the EU sustainability certification system is undermined without this information.
- The Commission recognised schemes that did not have appropriate verification procedures to ensure:
  - the origin of biofuels produced from waste was indeed waste
  - feedstock cultivated in the EU fulfil the EU environmental requirements for agriculture (a requirement of the RED).
- The Commission's assessment process does not cover schemes' governance, management, staff qualifications or transparency. Some recognised schemes were found to be insufficiently transparent or to have governance structures comprising only representatives from a few economic operators, increasing the risk of conflicts of interest and preventing effective communication with other stakeholders.
- The Commission's recognition was found to be based on a documentary review of procedures only; standards presented by the voluntary schemes as a basis for their recognition are not always applied in practice.



Modern waste biomass plant

- There is no means to detect alleged infringements of schemes' rules and neither a specific complaint system nor a check by the Commission to verify that complaints addressed to the schemes are correctly dealt with.
- Statistics reported by member states regarding meeting the stated targets might be overestimated because they can report biofuels as sustainable, even if sustainability is not in fact verified; this is due to the weaknesses in the recognition process for certification schemes detailed above. Problems were also identified with the comparability of data reported by the member states.

In addition to the ECA assessment, a number of studies have provided benchmarking and comparative analyses of the schemes. The findings detailed below are drawn primarily from study by the International Union for Conservation of Nature (IUCN)<sup>[78]</sup> who reviewed eight comparative studies that were conducted between 2009 and 2013 as well as a comparative study performed by WWF of the schemes certified by the Commission in 2013<sup>[79]</sup>. The WWF study was highlighted in both the IUCN's review and our stakeholder consultation for going beyond the content of schemes' standards to look at how they operate in practice. Common findings across the available analyses are as follows:

- There are strong differences in strictness of criteria and quality of control procedures within schemes<sup>[78]</sup>.
- The level of assurance offered by schemes is strongly determined by the rules governing them. These include the rules on the audit system (such as audit procedures, sampling requirements, verification procedures, quality requirements for auditors, and sanctions for non-compliance), the management system (level of transparency and accessibility of information, the level of stakeholder engagement, complaints systems) and the rules for the affiliation and for the acceptance of certificates from other (sometimes weaker) schemes<sup>[78]</sup>. Particular rules that WWF<sup>[79]</sup> raised concerns over are:
  - on-site documentation and implementation, especially for compliance-based schemes
  - remote (rather than on-site) audits of farms
  - group certification being granted to independently operated farms without strong internal control systems
  - a lack of well-developed monitoring and evaluation systems in all but one scheme.
- There is an important distinction between schemes designed specifically to meet market demand for compliance with the RED minimum criteria and those that have broader missions. Compliance-based schemes are weaker on social issues and tend not to include stakeholder engagement while others (RSPO, RSB, RTRS<sup>xii</sup> and Bonsucro) require multi-stakeholder engagement through all stages of standard-setting, implementation and further development. Both the IUCN and WWF argue that schemes with stakeholder engagement have stronger governance structures, transparency as well as audit and accreditation requirements<sup>xiii</sup>, thereby offering higher levels of assurance<sup>[78,79]</sup>.
- Almost all schemes have a general requirement for reducing the most hazardous agrochemicals (classes 1A and 1B defined by the World Health Organization) and substances banned by the Stockholm and Rotterdam Conventions, but most do not include clear restrictions on hazardous agrochemicals<sup>[79]</sup>.

xii The Roundtable on Sustainable Palm Oil (RSPO), Roundtable on Sustainable Biomaterials (RSB) and the Round Table on Responsible Soy Association (RTRS), respectively.

xiii The dominant schemes in the UK (eg. Red Tractor and International Sustainability and Carbon Certification (ISCC)) are compliance-based schemes in that they seek only to meet the minimum mandatory RED criteria. In the case of ISCC, voluntary add-ons that exceed the mandatory requirements are also available.





Storage of wood chips

Future development of second generation biofuels requires consideration of what audit and sustainability certification processes will be needed to ensure their sustainability. As some of the second generation feedstocks, such as energy crops, forest and sawmill residues, are already used for electricity generation, current regulation and certification schemes could potentially serve as a starting point. In the UK, electricity generation

from biomass is regulated under the Renewables Obligation Order (ROO)<sup>[80]</sup>. Much like the RED for biofuels, the ROO defines the criteria that must be met for biomass to be classed as 'sustainable' for regulatory purposes. A key criterion is that the biomass has to be grown in a way that is consistent with the Forest Europe *Criteria and Indicators of Sustainable Forest Management*<sup>[81]</sup> or equivalent standard. Importantly, evidencing this can be based on a regional



## AS POLICYMAKERS AND DEVELOPERS SEEK TO MOVE BIOFUELS AWAY FROM FIRST TOWARDS SECOND GENERATION FEEDSTOCKS, THE RELATIONSHIP BETWEEN THE CURRENT LEGISLATION AND THE CERTIFICATION SCHEMES COVERING THEIR USE IN ELECTRICITY GENERATION AND THE REQUIREMENTS FOR LIQUID BIOFUEL PRODUCTION NEED TO BE CLARIFIED AND HARMONISED.

assessment of the practices within a jurisdiction, rather than an audit at the level of individual forests; if regional assessment provides sufficient evidence that standards are met within a particular region, then the burden of individual supply chains within those regions is foregone. Where a risk is identified, more detailed assessments are required. Other key criteria include:

- the maintenance of carbon stocks in the land (a key issue relating to the carbon footprint of the feedstock, outlined in sections 6.5. and 6.6.)
- protection of local biodiversity (an issue discussed in section 7.4.)
- environmental and social considerations
- a requirement for biomass production to meet the EU Timber Regulation<sup>[82]</sup>, in place since March 2013, covering illegal timber trade.

There are a number of existing schemes that provide a basis for sustainability certification in the biomass-for-electricity sector, for example:

- the Programme for the Endorsement of Forest Certification (PEFC): an umbrella scheme for national forest certification schemes in 36 countries<sup>[83]</sup>
- Forestry Stewardship Council (FSC): a not-for-profit, global scheme covering forest management and chain of custody certification<sup>[84]</sup>
- the Sustainable Biomass Partnership (SBP): formed in 2013 by European utilities using biomass, mostly wood pellets and chips in large thermal generating plants<sup>[85]</sup>.

These schemes do not necessarily cover all of the requirements of the ROO for biomass used in the electricity generation sector (for example, only SBP covers the minimum GHG emissions savings), but they do form the basis of assurance for a number of the sustainability requirements. The key point is that there is significant overlap in the considerations required for liquid biofuels. As policymakers and developers seek to move biofuels away from first towards second generation feedstocks, the relationship between the current legislation and the certification schemes covering their use in electricity generation and the requirements for liquid biofuel production need to be clarified and harmonised.

A useful benchmark for improving biofuels certification schemes is the International Social and Environmental Accreditation and Labelling (ISEAL) Alliance<sup>[86]</sup>, an NGO seeking to strengthen

standards systems globally. Membership is open to all multi-stakeholder sustainability standards and accreditation bodies demonstrating an ability to meet the ISEAL *Code of Good Practice*. This is widely supported as a legitimate, effective and inclusive basis for developing standards and their underlying processes<sup>[79]</sup>. Of the 19 schemes currently recognised by the European Commission, three are full members of the ISEAL Alliance – RSB, Bonsucro and RSPO<sup>[87]</sup> – and these are all among the best performing in the IUCN and WWF comparative analyses<sup>[78,79]</sup>. They were also cited by international stakeholders consulted as part of this study as well-performing schemes. There is also an associate membership level, signifying that members are on the pathway to full membership; however, information is not available as to what schemes might be on this pathway. Stronger adherence to the ISEAL Alliance standard, which covers some of the key issues highlighted above, such as scheme governance, could be an effective way of strengthening biofuels certification.

For major fuel consumers and other stakeholders seeking to evaluate and understand the sustainability performance of different biofuel choices, or looking to evaluate options for specifying certification by one of the available voluntary schemes, the comparative analyses of schemes detailed above should prove useful, though not necessarily accessible or user-friendly. The Natural Resources Defense Council (NRDC) have also produced a reference document, providing a framework more specifically targeted at this purpose<sup>[88]</sup>. It provides guidelines that define a suite of voluntary sustainability indicators for biofuels that can be used to inform best value procurement decisions. This is based on economic, environmental and social sustainability criteria and associated performance indicators. In developing their guidelines, the NRDC drew from broader international codes of good practice like ISEAL and topic-specific protocol principles, such as the GHG Protocol – Product Life Cycle Accounting and Reporting Standard<sup>[74]</sup>. It is also structured to follow a life cycle approach in conformance with the ISO14040 standard<sup>[71]</sup>.

In summary, as the above discussion demonstrates, there are many certification schemes with differing criteria. While some require strengthening, both in terms of the breadth of the criteria covered and their governance and transparency, stakeholders consulted as part of this study (both within the UK and internationally) were generally of the view that they have driven an overall positive change in the biofuels sector that would not have happened in their absence.



Deforestation for palm oil production

# 6.

## Overview of life cycle assessment studies

This section provides an overview of how different studies covered in the review approached some critical elements of LCA, including goal and scope of the study, definition of the functional unit, LUC and consideration of soil and biogenic carbon.

### 6.1. Goal and scope of studies

Goal and scope definition is an important initial step in LCA studies as the specific methodological approaches depend strongly on the specific goal, scope and question being addressed. LCA studies of biofuels have addressed a wide range of goals and research questions, including:

- What are the environmental impacts of the biofuel system under examination?
- How do biofuels compare with the reference system (conventional fossil fuels)?
- What are the environmental hotspots in the life cycle of particular biofuel systems under study?
- What are the improvement options to optimise the supply chain under study?
- What are the environmental implications of biofuel policies?

The goal and scope of the study influence the definition of the system boundary, determining what activities and life cycle stages will be considered<sup>[71]</sup>. According to the ISO 14040 LCA standard<sup>[71]</sup>, when defining the goal of the study, the following should be stated clearly:

- the reasons for carrying out the study
- the intended application of the results
- the intended audience to whom the results will be communicated
- whether the results are intended to be used in comparative assertions to be disclosed to the public.

The ISO standard also requires that the definition of the scope of the study should include the following<sup>[71]</sup>:

- the product system to be studied and the system boundary
- the functional unit (unit of analysis)
- allocation procedures

## LCA PRACTITIONERS THAT GAVE EVIDENCE TO THIS STUDY REPORTED THAT A COMMON PROBLEM IN LCA STUDIES OF BIOFUELS WAS A LACK OF OR UNCLEAR DEFINITION OF GOAL AND SCOPE FOR THE STUDIES CONDUCTED. THIS CAN ALSO MEAN THE STUDY METHOD AND RATIONALE CAN BE UNCLEAR, MAKING COMPARABILITY OF RESULTS DIFFICULT.

- environmental impacts to be considered and the impact assessment method to estimate them
- data requirements, assumptions and limitations.

Despite the above requirements, the LCA practitioners that gave evidence to this study reported that a common problem in LCA studies of biofuels was a lack of or unclear definition of goal and scope for the studies conducted. This can also mean the study method and rationale can be unclear, making comparability of results difficult<sup>[67]</sup>. A further issue is that the detail of goal and scope is often lost if several studies, which may have been originally produced for a different purpose, are used to compare alternative products or to inform policy<sup>[89]</sup>.

Two types of system boundaries have been used in the reviewed LCA studies of biofuels: 'cradle to gate' (or 'well to tank') and 'cradle to grave' (or 'well to wheel'). However, the latter system boundary is more appropriate as it is important to include the use of fuels to enable comparisons of biofuels with their fossil substitutes, since the combustion performance and associated emissions of biofuels can significantly differ from their fossil substitutes for the same type of vehicle<sup>[90,91]</sup>.

Over half of the LCA studies reviewed (55%) considered a cradle-to-grave system boundary to compare environmental impacts of biofuels with fossil fuels, while the rest were from cradle to gate. Other inconsistencies include the omission in some studies of various inputs (such as enzymes, pesticides, fertilisers, etc.) and co-products. These differences are often important enough to influence the results significantly.

### 6.2. Functional units

In LCA, the term 'functional unit' describes the function of the system under study and represents the unit of analysis on which the study is based. The choice of the functional unit is driven by the goal of the study and must be representative of the system(s) studied and their main purpose (function). Biofuels regulations, such as RED and RTFO, use the energy content of biofuels (MJ) as the functional unit. While this functional unit was often used in the reviewed literature, others include the distance travelled by a vehicle (vehicle.km), volume (litre) and mass (kilogram or tonne) of biofuels. Some studies also used the mass of biofuel

feedstock<sup>[92,93]</sup>, agricultural land area<sup>[94,95]</sup> and annual operation of refinery<sup>[96]</sup>. The use of such a wide array of functional units makes comparisons of LCA studies challenging.

### 6.3. Allocation methods

Biofuel production processes often produce several co-products, such as animal feed, heat, electricity and biochemicals. Therefore, to determine the impacts from the biofuel of interest, it is necessary to allocate the impacts between the biofuel and its co-products. Allocation is one of the most controversial issues in LCA. The ISO 14040/14044 standards recommend that, if possible, allocation should be avoided through subdivision of processes, or by system expansion. In the system expansion approach, the production system is credited for displacing production of the co-products in alternative systems by subtracting the impacts from those alternative production systems from the biofuels production system. Hence, this method is also known as 'substitution' or the 'avoided burden' approach. If allocation cannot be avoided, the impacts can be allocated according to physical relationships, for example, in proportion to the mass or energy content, or by economic value, such as costs or prices of biofuel and its co-products.

Both system expansion and allocation are subject to shortcomings: for system expansion, the difficulty is to estimate various substitution effects (similar to the related consequential issues in CLCA), while different allocation methods produce very different results. For instance, allocation by mass could result in the majority of impacts being allocated to the co-products rather than the biofuel which is the main (economic) product, while allocation by product cost/price leads to changes in the estimates of environmental impacts over time with variations in costs/prices without any other changes in the system. Therefore, several allocation methods should always be considered in an LCA study to examine the sensitivity of results to this methodological choice.

In LCA of biofuels, the most common approaches used to apportion the impacts between the biofuel and its co-products are system expansion and allocation by the energy content. This perhaps reflects the regulatory requirements in the US and Europe: RED favours allocation based on the energy content of biofuels, while the US EPA prefers system expansion.



# THE EFFECTS OF ILUC AND HOW TO ACCOUNT FOR THEM IN ASSESSING THE SUSTAINABILITY OF BIOFUELS ARE KEY AREAS REQUIRING FURTHER RESEARCH AND CONSENSUS BUILDING. PART OF THE CHALLENGE IS CONSTRUCTING AND ANALYSING CREDIBLE COUNTERFACTUAL SCENARIOS.

Several studies considered more than one allocation approach and found that the results were highly affected. For instance, some studies<sup>[61,97]</sup> showed that biofuels had significantly lower environmental impacts when using system expansion instead of allocation. In some cases, system expansion can lead to the environmental impacts from biofuels having negative values, suggesting net savings of impacts, including GHG emissions. However, studies assessing uncertainty in LCA of biofuels showed that system expansion also results in higher uncertainties<sup>[98,99]</sup>. Other authors found that environmental impacts were higher if economic allocation was used instead of mass and energy allocation<sup>[100]</sup>.

During consultation, stakeholders also agreed that allocation is a significant challenge in biofuel LCA studies and the use of one particular method does not fully capture reality. It was also mentioned that for some biofuels (such as wheat ethanol and rapeseed biodiesel), the co-products are sufficiently substantial that choice of allocation procedure can tip the balance between net benefit and net impact. Some of the stakeholders disagreed with the RED's stipulation of energy allocation, favouring economic allocation instead. According to these stakeholders, the reason for this is that biofuel producers are economic operators and they are used to dealing with economic factors and consequences, including their variability. However, the latter makes comparisons of different biofuels even more challenging.

## 6.4. Land-use change: direct and indirect

LUC is an important source of GHG emissions that contributed  $660 \pm 290$  Gt CO<sub>2</sub> to the atmospheric CO<sub>2</sub> in the period from 1750 and 2011<sup>[101]</sup>. The reason for these CO<sub>2</sub> emissions is that soils and vegetation contain large stocks of carbon that are disturbed through LUC, with part of the stored carbon being oxidised and released to the atmosphere as CO<sub>2</sub> (see sections 6.5. and 6.6. for further details).

The majority of LUC is driven by demand for food, fibre and fuel<sup>[102]</sup>. An increasing global demand for biofuels highlighted the potential for the competition for land use between cropland and natural ecosystems. Converting natural vegetation or forest to cultivate biofuel feedstocks releases a significant amount of carbon from soil and plant biomass, creating a 'carbon debt' that can take years to repay<sup>[103,104]</sup>. Similarly, concerns over the potential carbon debt caused between harvesting and re-establishing timber stands have become an important issue for climate and bioenergy policy<sup>[105]</sup>.

Furthermore, cultivation of biofuel feedstocks on land that has high soil-carbon content, such as peat land, leads to a considerable increase in GHG emissions<sup>[106]</sup>. Besides increasing GHG emissions, changes in land use can have other environmental consequences, such as soil erosion, nutrient depletion, water consumption and loss of biodiversity<sup>[107]</sup>.

Early LCA studies on biofuels, which excluded LUC, concluded that first generation biofuels, such as corn ethanol, had lower carbon footprints than gasoline<sup>[108]</sup>. However, when attempts were made to account for the LUC effects of the expansion of first generation biofuels, these findings came under question<sup>[70,103]</sup>. This prompted a UK government-commissioned review that first recommended a slowing of the rate at which biofuels were introduced in the UK; specifically, that targets higher than 5% by volume should only be implemented beyond 2013/14 if biofuels were shown to be demonstrably sustainable, including avoiding ILUC<sup>[109]</sup>. Since then, several other studies have cast doubt on the ability of first generation biofuels to meet mandatory GHG emission targets if LUC is involved<sup>[110,111]</sup>.

LUC related to biofuels can occur in two ways: direct (DLUC) or indirect (ILUC). DLUC refers to the direct transformation of previously uncultivated areas (such as grasslands and forests) into croplands for biofuel feedstock production. ILUC occurs when additional demand for biofuel feedstock induces displacement of food and feed crop production to new land areas previously not used for cultivation. DLUC is strictly regulated through the RED sustainability criteria, while ILUC was not explicitly considered until 2015.

From an LCA perspective, DLUC is relatively straightforward and easy to include in the assessment, although the uncertainty remains high. Several approaches have been developed to calculate the changes in land-based carbon stocks related to the use of biomass. The Intergovernmental Panel on Climate Change (IPCC)<sup>[112]</sup> and the European Commission<sup>[15,113]</sup> have published guidelines for calculating the carbon stocks for agriculture, forestry and other land uses. The IPCC guidelines allow calculating changes in the stock of five carbon pools: above ground mass; below ground mass; dead wood; litter; and soil organic matter. The European Commission has proposed a simplified method by categorising the LUC emissions into two carbon pools: carbon stock and soil organic carbon (SOC).

ILUC associated with biofuels is a subject of an intense global debate because of the methodological and model uncertainties,



Palm oil plantation

with estimated GHG emissions from ILUC ranging from zero to 'very large'. For example, a study on the ILUC for US corn ethanol found the ILUC emissions varying from 10–340 g CO<sub>2</sub> eq./MJ<sup>[114]</sup>. This demonstrates that estimating ILUC from biofuel use remains difficult, complex and highly uncertain<sup>[115,116]</sup>.

For that reason, the effects of ILUC and how to account for them in assessing the sustainability of biofuels are key areas requiring further research and consensus building<sup>[102,116]</sup>. Part of the challenge is constructing and analysing credible counterfactual scenarios<sup>xiv</sup>. Another challenge is the economic (equilibrium) models used for consequential modelling<sup>[66,119]</sup> and the assumed yield-price elasticities for crops<sup>[63]</sup>. The lack of transparency in ILUC models, many of which are proprietary, is also problematic. These issues were also raised by stakeholders consulted in this study who appealed for efforts to increase model transparency, the understanding of LUC dynamics and impacts through stakeholder collaboration (see section 6.8. for more on assumptions and uncertainties, including existing efforts to address the challenges).

Given its focus on the potential effects of policy decisions, the stakeholder consultation conducted as part of this study highlighted international agreement that CLCA is highly relevant to policy formulation. However, there is an ongoing question about how policymakers should respond to the growing evidence on ILUC from biofuel production. The blanket application of 'ILUC factors' according to feedstock type is unpopular as it offers producers no opportunity to improve the performance of their individual supply chains<sup>[120]</sup>. Moreover, there are many other drivers of LUC besides biofuels, such as demand for food and timber, urban development and infrastructure, leading some to argue that it is unfair to consider ILUC for biofuels only<sup>[66,121]</sup>. Existing EU sustainability criteria prohibit expansion into forests, peat lands and areas with high biodiversity<sup>[15]</sup>. These measures mean that DLUC from biofuel

production is restricted and that biofuel feedstocks can be sourced from existing farms and plantations or cultivated on marginal or degraded land. However, unsustainable land conversion to meet demand for food, feed and materials, or to supply markets outside the EU, can still take place. Therefore, if sustainability criteria providing similar protections are not extended to and effectively enforced in the food, feed, materials and other related sectors, unsustainable land conversions are likely to remain a serious concern.

## 6.5. Biogenic carbon

In the context of biofuels, the term biogenic carbon refers to CO<sub>2</sub> that is sequestered from the atmosphere during the growth of feedstocks and subsequently released during the combustion of the biofuel or *via* decomposition of vegetation or biological waste (eg. forest and sawmill residues). 'Carbon neutrality' is achieved when CO<sub>2</sub> sequestered and subsequently released are in balance. However, carbon neutrality cannot be claimed if there is a potential imbalance between the amount of CO<sub>2</sub> taken up during feedstock growth and the amount released through biofuel production and use. The same applies if any time delay between CO<sub>2</sub> emissions and rebalancing through feedstock regrowth, the so-called 'payback period', is significant enough to impinge on targets for climate change mitigation (see discussion of carbon debt in section 6.4.).

Since many bioenergy products – including annual crops and perennial grasses – have relatively short lifespans, carbon neutrality is commonly assumed in LCA standards and regulations, including RED. Hence, most LCA studies of biofuels assume that biogenic CO<sub>2</sub> emissions, both from end-use combustion and the use of biomass during processing, such as the burning biomass to produce energy for conversion processes, are fully balanced by CO<sub>2</sub> uptake during

xiv Just one example of this is the question of 'forgone sequestration': the idea that, without demand for biofuels, cropland might decrease and partly revert to grassland or forest, accumulating carbon in natural vegetation. It can be argued that using more cropland to produce biofuel feedstocks in Europe slows down processes of land abandonment. This topic is, however, open to debate and the extent to which it would occur in reality is not well documented; cropland that is abandoned does not always automatically revert to forest. Due to these difficulties, some studies have, therefore, not included foregone sequestration (eg. IFPRI 2011 study<sup>[117]</sup>); however, those that have suggest that this has a material impact on the results (eg. <sup>[118]</sup>).





Forest management

feedstock growth. While this assumption is reasonable for fuels from annual crops and perennial grass feedstocks, it is open to challenge in relation to biofuel production from feedstocks with harvest cycles of more than a few years – such as longer-lived lignocellulosic feedstocks from forestry<sup>[63,122]</sup>. For such feedstocks, it is important to consider the balance of carbon sequestered during feedstock growth versus that which is emitted during biofuel production and use, together with the overall time profile of biogenic carbon storage, emission and re-sequestration<sup>[122]</sup>.

Forest bioenergy systems can have positive, neutral or negative effects on carbon stocks within forests, depending on the characteristics of the bioenergy system, soil and climate factors, the vegetation cover and land-use history in the given location<sup>[123]</sup>. Therefore, accounting of the temporary carbon storage in bio-based products is the subject of ongoing debate<sup>[124]</sup>. A lack of consensus on the basic science of biogenic carbon – especially for forestry feedstocks – and how these carbon flows should be handled in LCA was reported by stakeholders consulted during this study.

Different approaches to account for the temporal impact of carbon emissions are suggested in the literature; for example, carbon payback period, carbon discounting and time-integrated accounting of biogenic carbon<sup>[122,125]</sup>. Where accounting for the carbon storage in other, more long-lived bio-based products is required, there are various standards and methods<sup>[107]</sup> and these contain significant procedural differences. For example, GHG Protocol<sup>[74]</sup>, PAS 2050<sup>[73]</sup> and ISO 14067<sup>[75]</sup> require reporting of emissions and removal of GHG emissions from biogenic carbon sources while regulations

such as RED and the US EPA's Renewable Fuels Standard<sup>[65]</sup> do not require such reporting. Furthermore, the time between the production of the product (storage of biogenic carbon) and its end of life (release of the biogenic carbon), referred to as 'delayed emissions' varies among the standards. For instance, in PAS 2050<sup>[73]</sup> all emissions that occur within a 100-year period are quantified and treated as if they occurred at the beginning of the time period. By contrast, ISO 14067<sup>[75]</sup> makes a distinction between emissions released within and after the first 10 years.

The need to account for biogenic carbon is context dependent. If land or a forest has been managed historically for a very long time to produce bioenergy or the management practices are not altered as a result of biomass production, then there are, effectively, no biogenic carbon issues since the continuous cycling of CO<sub>2</sub> will have been established. This issue is well known in the pulp and paper industry. However, when there is a large-scale increase and/or intensification of production and changes to management practices, there is potentially a significant impact on carbon sequestered.

With a specific reference to forestry feedstocks, any method to account for biogenic carbon requires a dynamic model of how the forest growing stock will change and that accounts for changes in carbon flows. This requires a characterisation of the forests involved in supplying the biomass in terms of what the growing stock is, its growth rates, current management practices and how these may change against a range of realistic counterfactual scenarios<sup>[126]</sup>. Examples of such models include the European Forest Information SCENario (EFISCEN)<sup>[127]</sup>, the Global Forest Model (G4M)



## IF LAND OR A FOREST HAS BEEN MANAGED HISTORICALLY FOR A VERY LONG TIME TO PRODUCE BIOENERGY OR THE MANAGEMENT PRACTICES ARE NOT ALTERED AS A RESULT OF BIOMASS PRODUCTION, THEN THERE ARE, EFFECTIVELY, NO BIOGENIC CARBON ISSUES SINCE THE CONTINUOUS CYCLING OF CO<sub>2</sub> WILL HAVE BEEN ESTABLISHED.

<sup>[128]</sup>, CARBINE <sup>[129]</sup> and the Carbon Budget Model – Canadian Forest Sector (CBM-CFS) <sup>[130]</sup>. As with ILUC modelling, models seeking to characterise the stocks and flows of biogenic carbon need to be transparent, including the assumptions and the uncertainties of results (see section 6.8.).

Methodological decisions and assumptions on biogenic carbon in forest bioenergy systems have a strong influence on the outcome, partly explaining the strongly divergent views on the climate effects of bioenergy from forest feedstocks. Major methodological choices that can have large influence on results include <sup>[123]</sup>:

- the spatial and temporal system boundary
- definition of the counterfactual scenario
- what other economic and social aspects and market-mediated effects are considered.

This is one of the reasons why the use of forestry feedstocks for bioenergy has proved controversial as different studies tend to make differing methodological choices with respect to the above. For example, a recent study <sup>[131]</sup> that attracted much media attention in the UK was criticised by the IEA <sup>[132]</sup> for failing to adopt a long-term landscape-level view, realistic counterfactual scenarios and treat forestry feedstocks as part of a wider value chain.

Spatially, stand-level assessments consider a small part of the overall landscape and prescribe a strict sequence of events (site preparation, planting or natural regeneration, thinning and final felling) that, in reality, occur simultaneously across the forest landscape. A forest landscape can, in effect, be represented by a series of time-shifted stands at different stages of growth in a process of ongoing rotation. Landscape-scale assessments can provide a more complete representation of the dynamics of forest systems, integrating the effects of ongoing activities across the forest landscape that take place in response to bioenergy demand. The assessment outcome can, therefore, vary drastically depending on how the temporal carbon balance accounting window is defined. Assessments that take a long-term, landscape-level view are needed to align with timescales suitable for forest ecosystems and forest management planning <sup>[123,131,132]</sup>.

Similar to ILUC modelling, defining counterfactual scenarios is a significant challenge. Aside from their active management, forests have a natural carbon balance that changes over time. In the absence of bioenergy/biofuels feedstock production, forests might arguably be left to mature but if so, they are subject to a range of natural and human disturbances, such as disease or fires, which can

result in the release of sequestered carbon (including, for example, forest fires). Alternatively, they might also be harvested for alternative uses such as pulp, paper or other wood products. Such products will have various life cycles, storing carbon for potentially many years, but also releasing it in various ways, depending upon their end-of-life disposal. All of these factors make isolating the change that is attributable to the activities of interest in LCA studies a significant challenge.

It should be borne in mind that bioenergy from forest feedstocks is one of several products from forestry that also includes products, such as sawn wood, pulp, paper and chemicals. However, biofuels are often evaluated in isolation from this wider bioenergy system and its other products <sup>[123]</sup>. This is important as increase in demand for bioenergy feedstocks can incentivise investments to increase forest production and biomass output. Furthermore, forest owners may implement measures to protect their forests against disturbances by replanting and tending the forest, as well as introducing more productive tree species and provenances <sup>[123]</sup>. Integrated modelling that captures these economic and biophysical dynamics and interactions has been used to study how forest management will vary depending on the characteristics of expected demand, forest structure, climate and forest industry profile. One broad lesson from such studies is that the effects of bioenergy on atmospheric carbon are more variable than suggested by studies that exclude such factors <sup>[123]</sup>.

Considering forest bioenergy as an integrated system, utilisation of forest and sawmill residues and wood wastes for the production of liquid biofuels should avoid driving increased intensity of forest harvesting. This would otherwise be of concern: while increased forest utilisation and management can lead to the replacement of old forests with faster growing, more productive trees that sequester more carbon, conversion of forest type or a marked intensification in forest management can also lead to an overall reduction in the carbon sequestered in both the soil and flora <sup>[133]</sup>. However, there would need to be a very significant increase in bioenergy demand for production to expand into otherwise unmanaged forest areas or for forest management to be fundamentally restructured <sup>[126]</sup>.

It should be noted that, while the above discussion focused largely on forestry feedstocks, there are other feedstocks for which biogenic carbon may be an important consideration – an example is straw and the impact of its removal on soil organic carbon. The latter is the subject of the next section.

# A REVIEW OF AVAILABLE EVIDENCE FOUND THAT THE IMPACTS ON SOILS OF BIOMASS USE AND ITS INTENSIFICATION VARY GREATLY, DEPENDING ON MANY FACTORS, INCLUDING THE POLICY CONTEXT AND FOREST MANAGEMENT STRATEGY. **OVERALL, THERE ARE NO CONSISTENT, UNEQUIVOCAL AND UNIVERSAL EFFECTS ON SOILS OF MORE INTENSIVE BIOMASS HARVEST ON FOREST SITES.**

## 6.6. Soil organic carbon

Soil organic carbon (SOC) is one of the largest carbon pools in the Earth system<sup>[134]</sup>. Its balance is affected because of agricultural activities and LUC. Depending on various soil characteristics and agricultural practices, soil can act as either a sink or a source of carbon emissions. Soils may lose SOC by mineralisation through cultivation, emitting CO<sub>2</sub> to the atmosphere. Alternatively, SOC may increase through cropping, or from repeated addition of crop residues or organic manures<sup>[135]</sup>. When biomass is left to decay in the soil, a part of the carbon content of the biomass is sequestered into soil. Therefore, assuming biomass would have otherwise been left to decay in the soil, harvesting it decreases SOC and this may significantly affect the GHG balance of a biofuel<sup>[136,137]</sup>.

Changes in SOC can have a major influence on GHG emissions from LUC associated with biofuel feedstock production<sup>[134,138]</sup>. Therefore, quantifying changes in SOC storage is an important factor in estimating GHG emissions of biofuels<sup>[139]</sup>. However, most LCA studies do not account for potential SOC changes from biomass cropping systems. This is probably due to inherent complexity of soil science, the high degree of intra- and inter-site variability, substantial data uncertainties and the challenges of linking biomass feedstock supply to specific soils<sup>[107]</sup>. Furthermore, there is no consensus in LCA on how to account for SOC change of agricultural activities and delayed GHG emissions<sup>[140]</sup>. However, the work on developing models to estimate SOC emissions related to biofuels is ongoing<sup>[138,141,142]</sup>.

Cultivation of perennial energy crops, such as SRC and *Miscanthus*, could sequester into the soil CO<sub>2</sub> from the atmosphere at the rate of 2.2 t CO<sub>2</sub>/ha.yr<sup>[134]</sup>. However, the sequestration potential is very site-specific and highly dependent on former and current agronomic practices, previous land use, climate and soil characteristics<sup>[61,96,134,141-143]</sup>. On the other hand, reversal of grassland, woodland and perennial crops back to arable lands could reduce soil carbon by 0.6-1.7 t C/ha yr, which would be emitted to the atmosphere as CO<sub>2</sub> (2.2-6.2 t/ha yr). Many studies note that removal of crop residue for biofuel production can reduce organic matter inputs to the soil and therefore deplete SOC, but suggest that partial removal may be viable as long as the amount of the crop residue left in the field maintains SOC levels<sup>[134,144]</sup>. For example, a study that included the effects of the removal of corn residue across the US corn belt concluded that the carbon footprint of

corn-stover ethanol may exceed that of conventional gasoline<sup>[145]</sup>. Another study on wheat-straw ethanol suggested that there is only a 30% probability that it will achieve a 35% GHG emission saving target if SOC changes are included in the analysis<sup>[146]</sup>. Losses of SOC from residue removal could be mitigated through better soil management practices, including reduced tillage, no-till cover crops and application of manure, compost and biochar<sup>[147]</sup>.

The increased extraction of forest residues can also impact on SOC in forests, as well as the level of nutrients, such as phosphorous, entering the soil. However, a review of available evidence<sup>[123]</sup> found that the impacts on soils of biomass use and its intensification vary greatly, depending on many factors, including the policy context and forest management strategy. Overall, there are no consistent, unequivocal and universal effects on soils of more intensive biomass harvest on forest sites<sup>[123]</sup>.

## 6.7. Emissions of soil nitrous oxide

Emissions of nitrous oxide (N<sub>2</sub>O) arise from application of nitrogen fertiliser and decomposition of organic matter in soil. N<sub>2</sub>O is a potent GHG that has a GWP 298<sup>xv</sup> times higher than CO<sub>2</sub><sup>[101]</sup>; hence, its emission can have a significant effect on the GHG balance of biofuels. The N<sub>2</sub>O emissions are particularly significant for annual first generation biofuel crops since fertilisation rates are larger for these than for second generation biofuels from perennial energy crops, which are usually grown without fertilisers, except during the initial establishment of the crop<sup>[148]</sup>.

LCA studies often use the 'Tier 1' methodology developed by the Intergovernmental Panel for Climate Change (IPCC) to estimate N<sub>2</sub>O emissions from fertilisers<sup>[112]</sup>. According to this method, 1.0% to 1.5% of nitrogen in synthetic fertiliser applied to crops is emitted as N<sub>2</sub>O<sup>[112]</sup>. Since in reality the occurrence and level of N<sub>2</sub>O emissions depend on many factors, including soil characteristics and local weather following fertiliser application on the soil, the default IPCC emission factors represent an uncertain estimate<sup>[149]</sup>. For example, a study by Crutzen et al.<sup>[150]</sup> suggested that N<sub>2</sub>O emissions in feedstock production can be 3-5 times higher than those estimated based on IPCC methodology. Inclusion of these variable N<sub>2</sub>O rates leads to dramatically different estimates of GHG emissions in the life cycles of biofuels. For instance, for corn ethanol, 5% nitrogen conversion instead of 1.5% could change its GHG savings relative to petrol from around 40% to zero<sup>[151]</sup>.

xv Revised to 265 in the latest IPCC report [101] but the previous value of 298 is used in most LCA studies.



Soil scientist

Conversely, a recent five-year UK project involving 23 partners from government, industry and academia<sup>[152]</sup> concluded that N<sub>2</sub>O emissions averaged across arable land in the UK are below those predicted by IPCC guidelines. Compared to the default IPCC emissions factor of 1% (of the amount of nitrogen applied), direct N<sub>2</sub>O emissions from soil related to the use of fertilisers on crops for first generation biofuels were estimated to be, on average, 0.46% of the nitrogen applied. However, the study noted that any one instance of fertiliser application is subject to interacting effects of rainfall and soil type, such that fertiliser-induced emissions could also be larger than the default IPCC emission factors in the wetter regions of the UK.

The study also found that the abatement of N<sub>2</sub>O emissions from manufacture of nitrogen fertilisers reduced GHG intensities of wheat bioethanol by 15% and oil seed rape biodiesel by 16%. The project also analysed potential GHG mitigation measures, such as:

- fertilisers with low GHG emissions per unit of nitrogen applied
- selection of species, varieties and/or fertiliser systems that convert nitrogen more efficiently into harvestable biomass
- sourcing of crop produce from regions with low rainfall and light soils
- removal of crop residues (although this may reduce SOC stocks, as discussed in section 6.6.)

The maximum GHG mitigation potential that might be achieved from all of the above approaches was estimated to be around 30% for the harvested produce and 5% to 25% for their food or fuel products, depending on the contribution of crop produce to the total carbon footprint of the product<sup>[152]</sup>.

## 6.8. Assumptions and uncertainties

There are many sources of uncertainty in LCA of biofuels. These include methodological, data and model uncertainties<sup>[67,98,153,154]</sup>. Methodological choices, including different allocation methods, inconsistent system boundaries and the cut off criteria for auxiliary inputs, affect the outcome of the study. Data availability is often limited and was raised as a persistent challenge by LCA practitioners consulted as part of this study, both in the UK and internationally. This is particularly the case for second and third generation biofuels that, along with the associated process technologies, are still

under development. As such, the use of unrepresentative data or assumptions to fill data gaps becomes a source of uncertainty<sup>[67]</sup>. There is also a great deal of technical, spatial and temporal variability associated with agronomic practices, such as fertiliser inputs, cultivation intensities and yields, as well as with biofuel conversion processes. LCA results are highly sensitive to variations in crop yields, use of nitrogen fertiliser and energy sources for biofuel conversion processes. For energy crops, recognised sources of uncertainty are emissions of N<sub>2</sub>O and SOC during crop production<sup>[98,151,155,156]</sup>.

A further issue is that LCA relies on multiple and multi-scale models drawn from different scientific and engineering disciplines. One of the challenges associated with this is that these are changing rapidly as new scientific knowledge becomes available but updating these emerging insights in LCA is often lagging. For example, recent evidence suggests that 'black carbon' (a constituent of particulate matter PM<sub>2.5</sub>) could increase the carbon footprint of some biofuels significantly<sup>[157]</sup> as it is on average 900 times more potent than CO<sub>2</sub>, but so far this effect has largely been excluded from LCA studies. Another challenge is ensuring that the data and models from different disciplines that are used in LCA preserve reasonable levels of transparency, rigour and robustness to avoid misuse and misinterpretation<sup>[67]</sup>.

Proliferation of different LCA tools presents another problem and source of uncertainty. Even small inconsistencies in assumptions, data and models among these tools can lead to very different results with the same input data. For instance, the difference in the carbon footprint of biofuels can vary by 20% to 35% between the BioGrace and the Roundtable on Sustainable Biofuels tools<sup>[158]</sup>. This means that, by choosing a more favourable tool, operators could enhance the performance of their biofuel without any changes to the production process. Acknowledging this and ensuring consistency in underlying assumptions, data and models is key for effective use of LCA in policy<sup>[67]</sup>.

Although the ISO 14040 standard mentions some aspects related to uncertainty analysis as part of the Interpretation phase, no concrete guidance is provided. One of the ways to deal with the uncertainties is to achieve consensus on models, data and methodological choices among the scientific community. Furthermore, the goal and scope of the study, inventory data and methodological choices need to be communicated clearly as this is currently not always the case.



## WHEN APPLYING LCA FOR POLICY AND CORPORATE DECISION-MAKING, THERE IS A REAL CHALLENGE IN DEFINING MEANINGFUL SCENARIOS FOR HOW THE WORLD WOULD DEVELOP BOTH WITH THE BIOFUELS POLICY OR PRODUCTION IN PLACE AND IN COUNTERFACTUAL SCENARIOS WHERE THESE ARE ABSENT.

In terms of improving the availability of data, the LCA practitioners consulted during this study reported that there was much room for improvement in existing LCA databases and a need to develop better, open access databases with common assumptions. Many data in common usage were reportedly out-of-date and finding new data is often difficult and time consuming.

Methodologies defined for regulatory purposes can also be selected arbitrarily. For example, stakeholders consulted in this study highlighted the RED for excluding avoided emissions from diverting MSW from landfill and, more generally, not adequately taking into account what would otherwise happen if biofuel production did not take place (the counterfactual scenario).

While many studies on biofuels have examined multiple scenarios and conducted sensitivity analysis, only a few have conducted comprehensive uncertainty analyses<sup>[98,153,159]</sup>, demonstrating that the variability in results can be large. Thus, LCA studies of biofuels should include uncertainty and sensitivity analyses to quantify the effect of varying key model parameters and presenting results as ranges with confidence intervals or the probability distribution<sup>[137]</sup>. Such analysis would make the reliability of the findings easier to evaluate and would give more confidence in any policy or decision-making based on these studies.

When applying LCA for policy and corporate decision-making, there is also a real challenge in defining meaningful scenarios for how the world would develop both with the biofuels policy or production in place and in counterfactual scenarios where these are absent. This is true for individual feedstocks all the way up to the economic and energy system models incorporated into CLCA studies. Projections of future economic growth, fossil fuel prices, energy generation costs, population and future climates often used (implicitly or explicitly) in CLCA are all uncertain.

Models for estimating DLUC and ILUC are another source of uncertainty in LCA<sup>[98,99]</sup>. In the case of ILUC, projections of up to 20 years into the future are made with common assumptions including that:

- All land is privately owned and managed to maximise profit, while in reality the land assumed to be converted can be public property<sup>[160,161]</sup> and farmers in the neighbouring agricultural frontiers often lack secure land titles<sup>xvi [163,164]</sup>.

- Elasticity factors and mathematical functions in the ILUC models are driven by relative global commodity prices and levels of crop substitutions. These determine the levels of LUC simulated while, in reality, this is driven by complex interactions among many local factors, including governance, policies, poverty and land speculation or clearing to stake land claims<sup>[163-165]</sup>.
- Land is either fully utilised or in a stable, natural state. This assumption simulates biofuels displacing a current productive use or leading to land conversion. In reality, less than one quarter of global, non-forest, arable land is cultivated and there is scope to improve management and productivity on previously cleared land<sup>[164]</sup>.
- In the absence of management, models often assume natural forest regrowth whereas, in reality, underutilised arable lands can suffer persistent disturbance<sup>[165,166]</sup>.

Given such assumptions, it is important to stress that ILUC models estimate how much indirect change might be induced under prescribed scenarios and thus only apply for the assumed conditions. By including some mechanisms that are assumed to cause deforestation, such as increases in crop prices, while omitting other mechanisms, such as local policies and governance, model assumptions drive the simulated results and must be interpreted with caution<sup>[164]</sup>.

There is ongoing effort internationally to improve the understanding and transparency of ILUC models. For instance, USA EPA estimates ILUC factors using data from at least eight models, including Forestry and Agricultural Sector Organization Model (FASOM)<sup>[65]</sup>. In Europe, the latest of a number of large studies<sup>[117,167]</sup> uses the Global Biosphere Management (GLOBIOM) model and has engaged multiple stakeholders in the development and testing of scenarios and assumptions<sup>[118]</sup>. Another relevant study is the Agricultural Model Intercomparison and Improvement Project (AgMIP), which aims to:

- improve agricultural models based on their intercomparison and evaluation using high-quality global and regional data and document improvements for use in integrated assessments
- utilise multiple models, scenarios, locations, crops/livestock, and participants to explore uncertainty and the effects of data and methodological choices

xvi Under such conditions, land-clearing is often a key step in the process of staking claims for eventual tenure of the land<sup>[162]</sup>.

*Miscanthus* crop

- develop modelling frameworks to facilitate data-sharing<sup>[168]</sup>.

The project also has activities specifically addressing bioenergy crops, including developing new field-scale pilot projects to improve crop models and developing protocols for intercomparison and improvement of models for existing and emerging biomass and bioenergy crops<sup>[169]</sup>.

Some stakeholders consulted in this study also recommended developing scenario storylines with stakeholders for greater transparency and understanding among stakeholders. An example of such an approach is the E4Tech study<sup>[170]</sup> which used a methodology based on descriptive, cause-and-effect logic to develop a framework for describing and deriving the ILUC

impacts from biofuels. An expert advisory group and stakeholder feedback were used to inform and validate the methodology and assumptions. E4Tech claims that its approach is more transparent and participative compared to the economic equilibrium modelling typically used in ILUC studies. Many stakeholders consulted as part of this study also cautioned against being too attracted to economic models and the quantified outputs they provide since these can hide underlying opinions and assumptions. However, while involving stakeholders can help test and clarify methods, scenarios and assumptions, uncertainty will remain and stakeholders may not necessarily reach agreement.





Harvesting sugar beet

# 7.

## Overview of environmental sustainability of biofuels

This section discusses the life cycle environmental impacts of biofuels as reported in the LCA studies reviewed. Given that reduction of GHG emissions is the main environmental driver for the use of biofuels, the carbon footprint is discussed first, followed by energy and water use and some other environmental impacts covered in the LCA studies. Most LCA studies on biofuels found in the literature are attributional.

### 7.1. Carbon footprint of biofuels

GHG emissions and savings in comparison to fossil fuels are the centre of attention in most LCA studies on biofuels. Regarding GHG savings, the studies present contradictory results from favourable to unfavourable, even for the same type of feedstock. This is a result of the differences in the LCA aspects discussed in section 6... The carbon footprints of biofuels reported in the reviewed LCA studies are summarised in Figure 5 to Figure 9 and discussed in sections 7.1.1 and 7.1.2. For further details on the carbon footprints of biofuels, see Appendix 4. Note that in LCA, the carbon footprint is also referred to as global warming potential.

#### 7.1.1. First generation biofuels

Figure 5 and Figure 6 show the carbon footprints for first generation biofuels relative to fossil fuels. As can be seen in Figure 5, the estimated carbon footprints of bioethanol from different feedstocks vary considerably, ranging from 4 to 138 g CO<sub>2</sub> eq./MJ. If the average values are considered and no LUC is involved, the carbon footprint of bioethanol is lower than that of petrol for all the feedstocks (25-73g CO<sub>2</sub> eq./MJ vs 83.8g CO<sub>2</sub> eq./MJ specified in the RED and RTFO). However, even without LUC, only bioethanol from sugar cane can meet the RED requirement of 50% reduction in GHG emissions relative to petrol (although the requirement rises to 60% from 1 January 2018 for new plants commencing operations after 1 January 2017). The average reductions in emissions from the other three feedstocks - corn, wheat and sugar beet - are not sufficient to meet this requirement. With LUC, bioethanol cannot meet the 50% requirement regardless of the type of feedstock<sup>[98,111,171,172]</sup>.

The main reasons that bioethanol from sugar cane can meet the 50% requirement (without LUC) are relatively lower inputs of agro-chemicals and higher yields of sugar cane crops as well as the credits for electricity produced in a biorefinery as a co-product. However, in Brazil, the largest sugar cane producer globally, the increasing demand for bioethanol from sugar cane has led to a continuous expansion of land used for sugar cane production<sup>[104,173]</sup>.

Legend for Figure 5-Figure 10

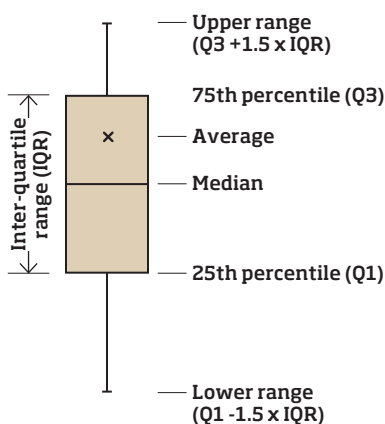



**Figure 5**  
Carbon footprint of first generation bioethanol

[Based on data from [98,99,111,156,171,172,174,178-201]. For the data used to plot this graph, see Figure A1 in Appendix 4. "Petrol (reference)" is the average carbon intensity of petrol and diesel supplied in the EU (83.8 g CO<sub>2</sub> eq./MJ) as specified in the EU RED and RTFO. A new EU directive [202], still under consideration, proposes a new average value of 94.1 g CO<sub>2</sub> eq./MJ for both fossil fuels. The guidance for 2016/17 states that RTFO will be amended accordingly [20]. The GHG reduction requirement rises to 60% from 1 January 2018 for new plants commencing operation after 1 January 2017. "A" refers to the number of LCA articles found in the literature and "n" refers to the number of analyses (sample size). NB: Most papers analysed several cases.]

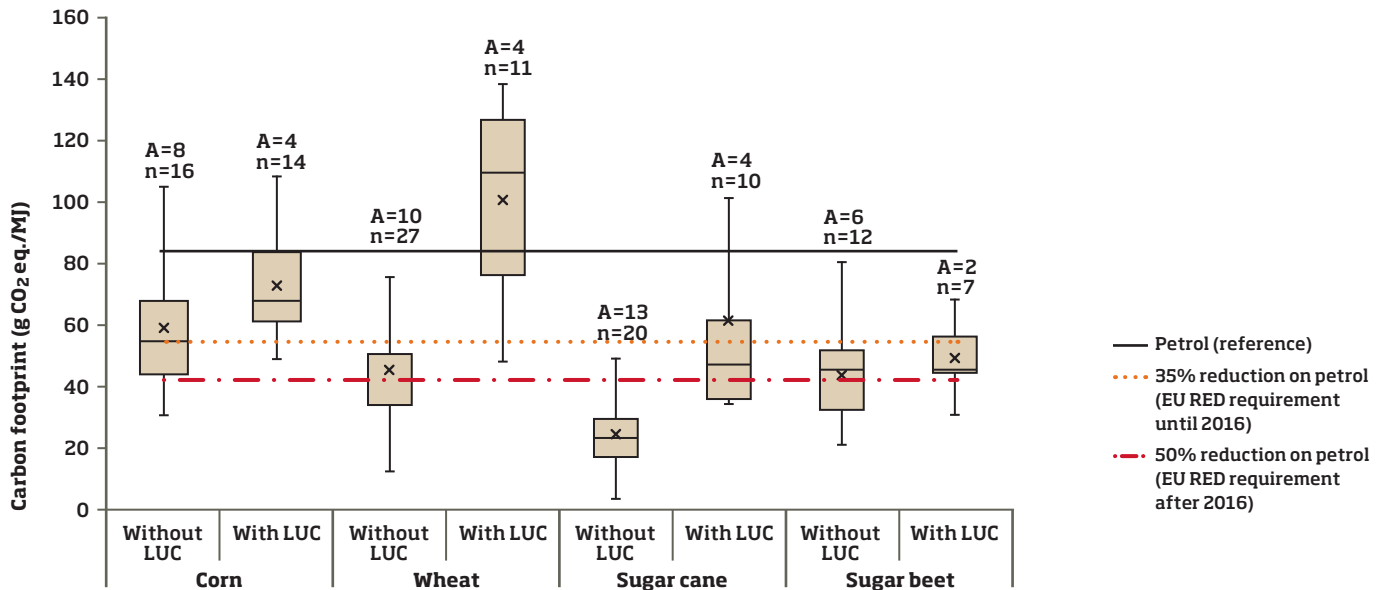

**Figure 6**  
Carbon footprint of first generation biodiesel

[Based on data from [25,99,156,172,175,177,184,190,197,201,203-230]. For the data used to plot this graph, see Figure A2 in Appendix 4. "Diesel (reference)" is the average carbon intensity of petrol and diesel supplied in the EU (83.8 g CO<sub>2</sub> eq./MJ) as specified in the EU RED and RTFO. A new EU directive [202], still under consideration, proposes a new average value of 94.1 g CO<sub>2</sub> eq./MJ for both fossil fuels. The guidance for 2016/17 states that RTFO will be amended accordingly [20]. The GHG reduction requirement rises to 60% from 1 January 2018 for new plants commencing operation after 1 January 2017. "A" refers to the number of LCA articles found in the literature and "n" refers to the number of analyses (sample size). NB: Most papers analysed several cases.]

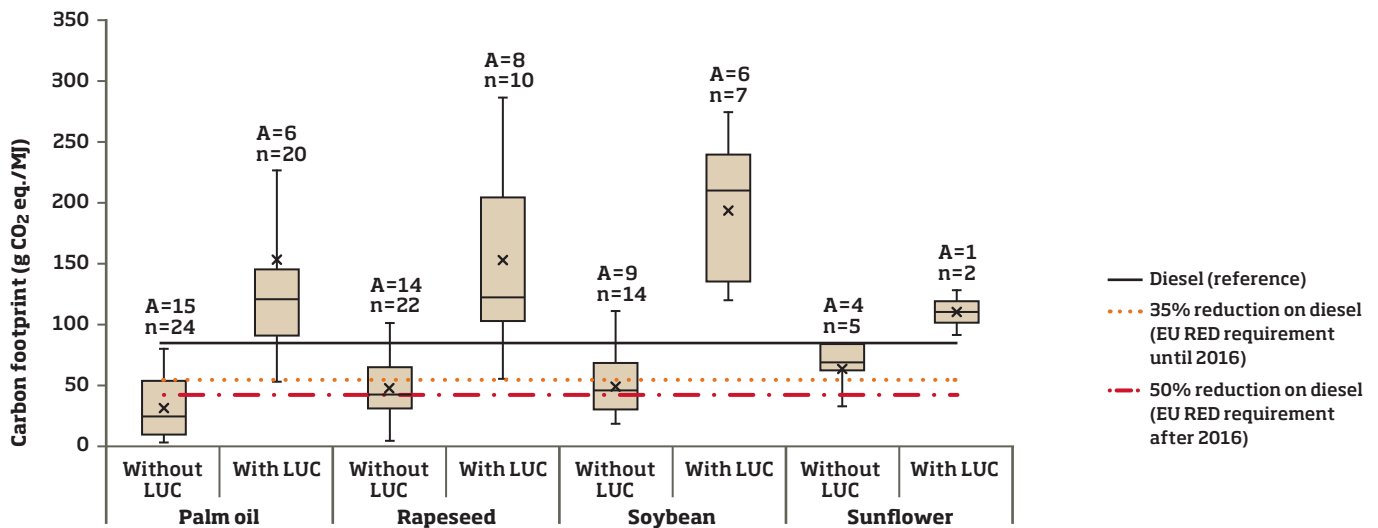

If this involves deforestation of tropical rainforest, the carbon footprint of bioethanol from sugar cane can be up to 60% higher than that of petrol [174] (see Figure A1 in Appendix 4). Pre-harvest burning (to help manual harvest) and associated changes in SOC<sup>xvii</sup> could also significantly affect the GHG balance of sugar-cane ethanol [173]. These effects are often ignored in LCA studies.

However, our stakeholder consultation with Brazilian experts suggested that the practice of pre-harvest burning is being phased out successfully.

The GHG emissions for first generation biodiesel also show a large variation across the LCA studies reviewed, with the carbon footprint

xvii Field burning is often carried out prior to a sugar cane harvest to make the process easier and require less labour. The burning of biomass means that far less crop residues are left on the land to be incorporated into the soil, impacting upon SOC.



Forest residues

ranging between 4 and 505 g CO<sub>2</sub> eq./MJ (see Figure A2 in Appendix 4). However, as shown in Figure 6, the average carbon footprint of biodiesel from all the feedstocks considered is lower than that of fossil diesel if no LUC is involved. Nevertheless, only biodiesel from palm oil meets the RED requirement for 50% reduction of the carbon footprint relative to diesel (average value). Rapeseed and soybean also come close to fulfilling this requirement but sunflower biodiesel cannot meet even the 35% reduction.

The results that include LUC indicate that biodiesel from all the feedstocks has higher average carbon footprint than diesel. Soybean is the worst option, because expansion of soybean cultivation in Central and South America is driving both direct and indirect LUC<sup>[175,176]</sup>. Similarly, cultivation of palm trees in Malaysia and Indonesia is associated with deforestation and drainage of peat lands. As a consequence, biodiesel from palm oil on peat and forest lands can have three to 40 times higher GHG emissions than diesel<sup>[177]</sup>. The findings of a recent study assessing the LUC impact of biofuels consumed in Europe<sup>[118]</sup> also suggest that the carbon footprint of palm oil and soybean diesel is very high, almost three and two times higher than that of diesel, respectively. The same study also estimates the carbon footprint of biodiesel from rapeseed and sunflower to be 20% to 40% higher than from conventional diesel.

The significant variability in the results related to LUC is due to several reasons. For example, some authors considered only ILUC<sup>[98,111,171,172]</sup> or DLUC<sup>[99,174,178,179]</sup>, while others included

both<sup>[180,181]</sup>. Furthermore, some studies applied partial equilibrium models and counterfactual scenarios to estimate ILUC emissions<sup>[98,111,172]</sup> whereas others used ILUC factors recommended by the US EPA<sup>[171]</sup>. For DLUC, several authors focused only on SOC changes<sup>[99,180]</sup>, but others also considered changes in the carbon stock related to the removal of biomass both above and below the ground<sup>[174,179,181]</sup>.

### 7.1.2. Second generation biofuels

Figure 7 and Figure 8 indicate that the average carbon footprints of second generation biofuels are considerably lower than those of conventional fossil fuels. However, there are large variations among different studies and feedstocks, with the values ranging from -115 to 105 g CO<sub>2</sub> eq./MJ for bioethanol and -88 to 80 g CO<sub>2</sub> eq./MJ for biodiesel. These variations reflect the diversity of feedstocks and production routes, technology assumptions and methodological differences. Furthermore, some studies also considered emissions from ILUC<sup>[111]</sup> and SOC sequestration<sup>[181,231]</sup> associated with the production of SRC and perennial grasses as well as the reductions in SOC with removal of agricultural residues used as biofuel feedstocks<sup>[181,232]</sup>. The uncertainty regarding technologies plays a particularly important role in the assessment of advanced biofuels as these are yet to be fully commercialised. Therefore, the quality of the available data is not as robust as in the case of the well-established first generation biofuels.



**Figure 7**  
Carbon footprint of second generation bioethanol

[Based on data from <sup>[61,62,96,97,111,154,171,174,178,181,195,198,231,232,239-265]</sup>. For the data used to plot this graph, see [Figure A3](#) in Appendix 4. The negative values are due to the credits for co-products, such as heat and chemicals. "Petrol (reference)" is the average carbon intensity of petrol and diesel supplied in the EU (83.8 g CO<sub>2</sub> eq./MJ) as specified in the EU RED and RTFO. A new EU directive <sup>[202]</sup>, still under consideration, proposes a new average value of 94.1 g CO<sub>2</sub> eq./MJ for both fossil fuels. The guidance for 2016/17 states that RTFO will be amended accordingly <sup>[20]</sup>. The GHG reduction requirement rises to 60% from 1 January 2018 for new plants commencing operation after 1 January 2017. "A" refers to the number of LCA articles found in the literature and "n" refers to the number of analyses (sample size). NB: Most papers analysed several cases.]

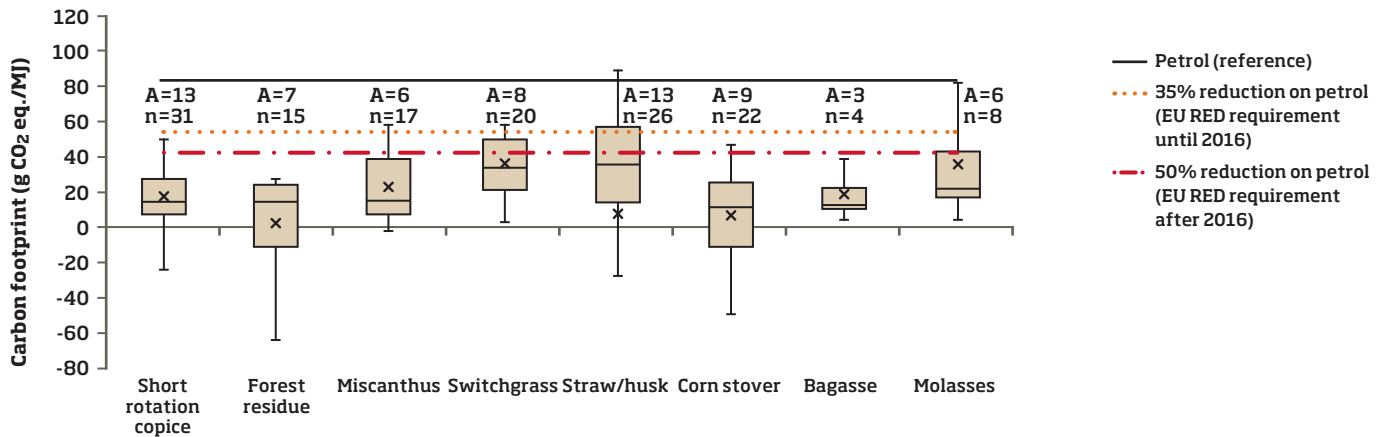

In general, lignocellulosic bioethanol from agricultural and forest residues has a lower carbon footprint than bioethanol from energy crops (see [Figure 7](#) and [Figure A3](#) in Appendix 4). This is because of N<sub>2</sub>O emissions during the cultivation of energy crops, related to the use of fertilisers, which are avoided in the case of residues.

The lower GHG emissions from lignocellulosic bioethanol compared to petrol are mainly a result of the assumption that the residual lignin is used to co-generate heat and power, with some of the latter exported to the grid. The biofuel production system is thus credited for avoiding the GHG emissions from the equivalent amount of grid electricity. For some feedstocks (SRC, forest residue, straw and corn stover), the credits for electricity generation and other co-products are higher than the direct emissions from the biofuel production process. These studies report negative carbon footprints, indicating the avoidance of GHG emissions. Some studies reported negative GHG emissions even with LUC included, notably for ethanol from SRC and perennial grasses <sup>[111,181]</sup>. This is mainly because of the increase in the carbon stock on the land that was converted to produce these crops <sup>[118]</sup> which leads to negative overall GHG emissions. On the other hand, harvesting of agricultural and forest residues can result in reduction of the carbon stock in the land <sup>[233-235]</sup>, so increasing GHG emissions <sup>[234,235]</sup>; however, most of the reviewed studies did not account for these changes.

Despite the negative values for GHG emissions for some second generation biofuels, a UK study <sup>[97]</sup> found that their potential to reduce the carbon footprint of transport fuels at the national level is small at the current blending levels of 5% (E5). The overall estimated CO<sub>2</sub> eq. saving of the E5 blend over petrol ranges between 2.6% and 3.2% per MJ of fuel. If 5% of bioethanol was added to all the petrol used annually in the UK, it would be equivalent to an average total reduction in GHG emissions of 0.35% per year <sup>[97]</sup>. Thus, these findings suggest that much higher blends would be needed for more significant reductions in GHG emissions from transport.

While LCA studies of second generation bioethanol cover a wide range of feedstocks, the studies of biodiesel are more limited, focusing largely on three feedstocks: *Jatropha*, *Camelina* and used cooking oil/tallow. As can be seen in [Figure 8](#) and [Figure A4](#) in Appendix 4, the average carbon footprints of *Jatropha* and

used cooling oil/tallow are very similar (26 and 27 g CO<sub>2</sub> eq./MJ), followed closely by *Camelina* (33 g CO<sub>2</sub> eq./MJ). However, they vary widely across the three feedstocks because of variations in the yield in different regions covered, differences in processes and assumptions, especially with respect to co-product allocation. For example, the yield of *Jatropha* oil seeds varied in different studies by a factor of 30, from 0.4 to 12 t/ha.yr <sup>[236]</sup>. The influence of allocation is also significant: using system expansion according to the US EPA methodology results in the carbon footprint of *Jatropha* biodiesel of -88 g CO<sub>2</sub> eq./MJ, while energy allocation as per the RED approach yields GHG emissions in the range of 15-20 g CO<sub>2</sub> eq./MJ <sup>[237]</sup>.

Most of the studies of biodiesel from used cooking oil (UCO) report carbon footprints 60% to 90% lower than conventional diesel. However, as shown in [Figure 8](#), some studies also estimate that the GHG savings from this type of biodiesel are not sufficient to meet the 50% reduction target. This is due to some specific assumptions. For example, Intarapong et al. <sup>[209]</sup> considered pyrolysis for conversion of UCO to biodiesel, which is more energy intensive than transesterification. Similarly, another study <sup>[184]</sup> assumed only a 5% biodiesel production yield which is very low compared to more than 90% considered in other studies. Furthermore, a consequential LCA study <sup>[238]</sup> that considered indirect impacts, such as changes in the production of palm oil, soybean and production of animal feed, suggests that ILUC and other indirect market impacts could have a significant influence on the carbon footprint of UCO biodiesel, which would be only 25% lower than that of diesel.

### 7.1.3. Third generation biofuels

Over 20 LCA studies have considered the carbon footprint of third generation, algal biodiesel. However, they have all used very different approaches, process designs, system boundaries, methodologies and assumptions for feedstocks, nutrients and co-product management. As a result of the variation in these choices, the carbon footprints differ widely between the studies, ranging from -2400 to 2880 g CO<sub>2</sub> eq./MJ (see [Figure 9](#) and [Figure A5](#) in Appendix 4). These results would suggest that microalgae diesel can both reduce and increase GHG emissions significantly relative to biodiesel, depending on the assumptions. However, the studies that report the high savings of GHG in comparison to diesel are based



**Figure 8**  
Carbon footprint of second generation biodiesel

[Based on data from [184,203,209,227,237,238,270-283]. For the data used to plot this graph, see Figure A4 in Appendix 4. The negative values are due to the credits for co-products. "Diesel (reference)" is the average carbon intensity of petrol and diesel supplied in the EU (83.8 g CO<sub>2</sub> eq./MJ) as specified in the EU RED and RTFO. A new EU directive [202], still under consideration, proposes a new average value of 94.1 g CO<sub>2</sub> eq./MJ for both fossil fuels. The guidance for 2016/17 states that RTFO will be amended accordingly [20]. The GHG reduction requirement rises to 60% from 1 January 2018 for new plants commencing operation after 1 January 2017. "A" refers to the number of LCA articles found in the literature and "n" refers to the number of analyses (sample size). NB: Most papers analysed several cases.]

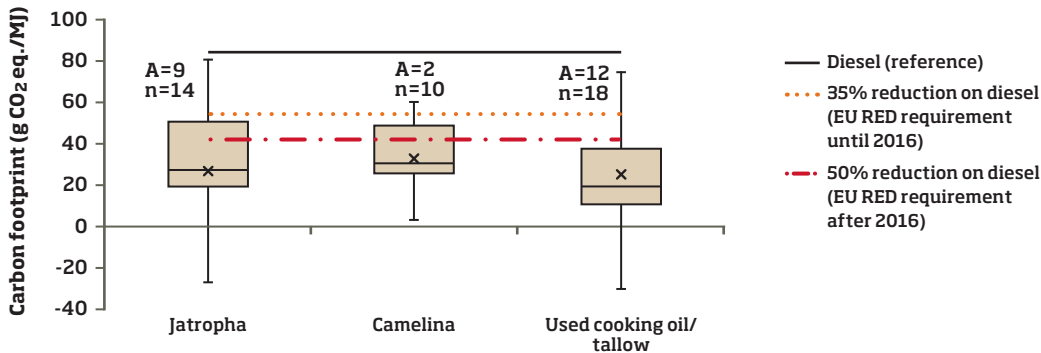

**Figure 9**  
Carbon footprint of microalgae biodiesel

[Based on data from [45,159,194,227,248,264,268,269,273,284-293]. For the data used to plot this graph, see Figure A5 in Appendix 4. The negative values are due to the credits for co-products and avoided processes, such as wastewater treatment. The GHG reduction requirement rises to 60% from 1 January 2018 for new plants commencing operation after 1 January 2017. "A" refers to the number of LCA articles found in the literature and "n" refers to the number of analyses (sample size). NB: Most papers analysed several cases.]

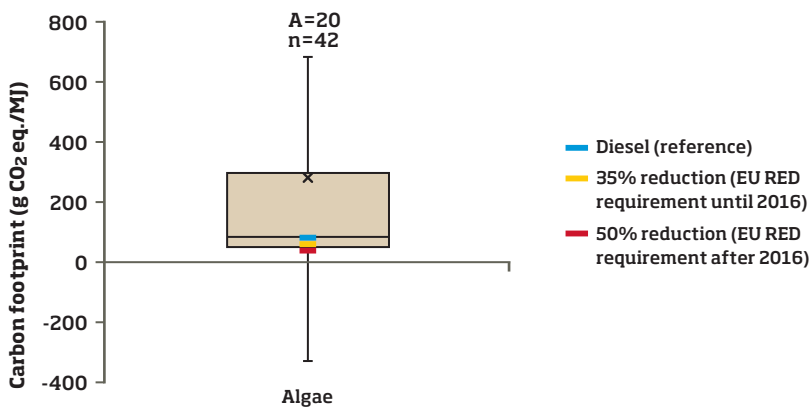

on the best-case assumptions that may not be feasible for large-scale implementation; for example, the use of CO<sub>2</sub> from cement plants as a feedstock [266], cane sugar as a nutrient/feedstock [267] and recycling of nutrients from anaerobic digestion plants [268] or wastewater [269]. Considering the average values across all the studies, the carbon footprint of microalgae diesel is around 3.5 times higher than that of diesel. Therefore, at present state of development, this type of biofuel does not represent a feasible alternative to fossil diesel.

## 7.2. Energy use

Several indicators are used in LCA studies to quantify energy use in the life cycle of biofuels, including fossil energy consumption, primary, secondary or cumulative energy demand and net energy ratio [294]. Given that energy security and independence from fossil energy are key motivators for biofuel production (in addition to climate change mitigation), most studies focus on fossil energy consumption. This is expressed in terms of MJ of fossil energy consumed per MJ of biofuel produced as discussed below.

As indicated in Figure 10 and Figure A6 in Appendix 4, most estimates put the fossil energy demand for first and second

generation biofuels at below 0.5 MJ/MJ. However, there is a wide variation across different types of biofuels, ranging from 0.04 to 0.86 MJ/MJ for first generation and -0.57 to 0.87 MJ/MJ for second generation biofuels, where negative values are due to energy credits from co-products, such as electricity and heat. These variations result from several factors, including differences in feedstock productivity, agricultural practices, conversion technologies and allocation methods. The results are also affected by the assumption on the type of energy (biomass or fossil) used in the conversion process.

The range of estimated values for fossil fuel consumption in the life cycle of algal biodiesel is even wider, ranging from 0.15 to 33.4 MJ/MJ (Figure 10 and Figure A6). Like the carbon footprint results, the reasons for this variation are technological uncertainties and the diversity of potential feedstocks and production systems. However, most studies agree that algal biofuels are not energetically viable because of high energy requirements for pumping, dewatering, lipid extraction and thermal drying [248,284,295,296]. In general, algae cultivation in raceway ponds has lower energy demand than photobioreactors, with some studies suggesting that the former can have energy demand of less than 1 MJ/MJ [296].

**Figure 10**  
Fossil energy use in the life cycle of biofuels

[Based on data from [45,61,62,96,97,159,171,174,175,181,182,184,187-189,193-195,203,205,211,217,219,220,226,228,229,232,238-240,243,245,246,250,251,254,259,260,262,264,265,269-273,275,276,280,281,284-289,297-301]. For the data used to plot this graph, see Figure A6 in Appendix 4. The value for third generation biodiesel should be multiplied by 10 to obtain the actual value. "A" refers to the number of LCA articles found in the literature and "n" refers to the number of analyses (sample size). NB: Most papers analysed several cases.]

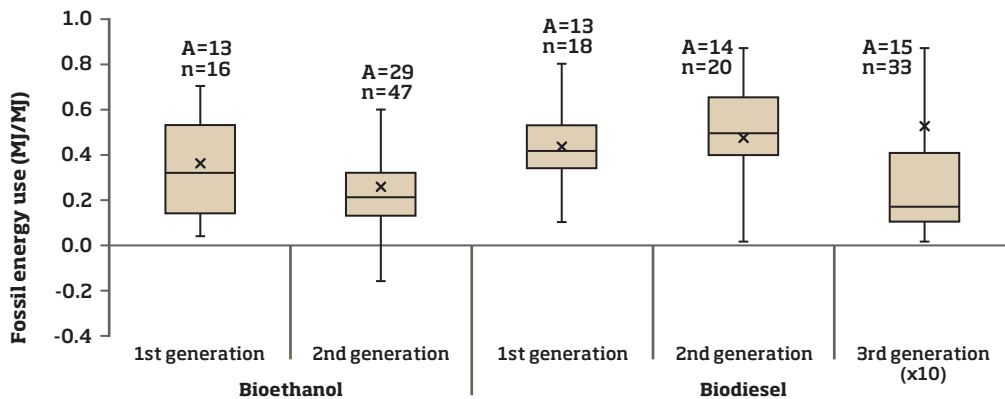

**Figure 11**  
Blue water consumption for biofuels consumed in Europe (based on data from [306]) [Data labels represent the average values.]

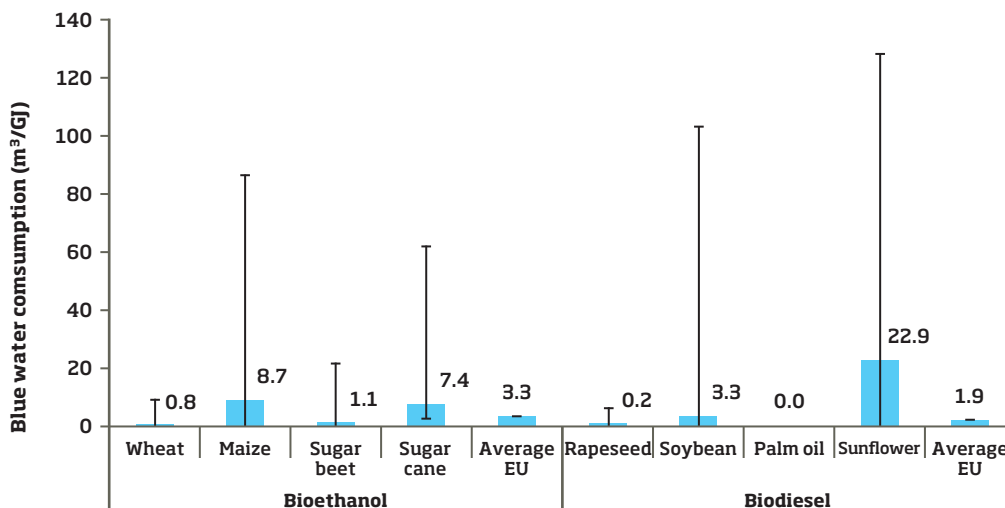

### 7.3. Water use

Water use in the production of bio-feedstocks can be high, particularly for first generation biofuels [11,302]. This is of concern where requirements for irrigation water for certain feedstocks might compete with water used for other purposes, such as food production. With increased agricultural biomass production for biofuels, the total global water consumption could increase significantly by 2050 [303] and, in areas that are already water stressed, additional water demand has a potential to increase substantially the overall environmental impacts of biofuels.

Water use is usually not included in LCA studies of biofuels, but there are numerous studies that have specifically focused on this aspect of biofuels production. Most of these studies provide a volumetric usage of water, such as the amount of green (rain) and blue (surface) water. This is not sufficient to assess local environmental impacts of water consumption as these are highly dependent on the level of water availability in the local area and the specific characteristics of the hydrological cycle, even if the quantity used is the same for a particular product [304]. Furthermore, consideration of green water results in very large total water

use for most agricultural crops. Since the local hydrological cycle may in reality be little affected by the use of green water in agriculture, inclusion of green water could be misleading and could overestimate the actual impact of water use for biofuels [305].

The results of a recent study [306] that assessed the water footprint of first generation biofuels consumed in Europe suggests that blue water consumption of biofuels is very diverse, depending on the underlying crop and country (see Figure 11). Bioethanol from sugar beet and wheat has lower water consumption because many countries produce crops using little or no irrigation. In contrast, the production of bioethanol from corn in Portugal consumes 86 m<sup>3</sup>/GJ. Furthermore, while no irrigation is needed to cultivate crops for biodiesel in the UK, Poland and Germany, in Spain, an average 90 m<sup>3</sup> of irrigation water is consumed to produce 1 GJ of crop-based biodiesel [306].

As indicated in Figure 11, the average blue water consumption of bioethanol and biodiesel consumed in Europe is 3.3 m<sup>3</sup>/GJ and 1.9 m<sup>3</sup>/GJ, respectively, which is 40 and 60 times higher compared to their respective fossil alternatives. If regional water stress is taken into account, as opposed to just the volume of water consumed,



Sawmill residue

biofuels have water footprints a factor of 55 to 246 higher than fossil fuel <sup>[306]</sup>. This is a result of a large share of water consumption in the production of biofuels occurring in relatively water-stressed countries.

The blue water consumption of algae-based biofuels can be higher or lower than first generation biofuels, depending on the geographic location, production systems and conversion routes <sup>[307]</sup>. For example, the blue water consumption for biofuels produced in a closed photo-reactor in the Netherlands is estimated at 8 m<sup>3</sup>/GJ, while it can be as high as 193 m<sup>3</sup>/GJ if algae are cultivated in open pond systems in Hawaii <sup>[307]</sup>. There is also a difference between dry and wet conversion with the blue water consumption being higher for the latter.

## 7.4. Biodiversity

The relationship between biofuels and biodiversity is complex. Biofuels have the potential to contribute to loss of biodiversity through habitat loss and degradation, excessive nutrient load and other forms of pollution, over-exploitation and unsustainable use of land, as well as the cultivation of invasive alien species used as feedstocks <sup>[308]</sup>. The impact of biofuel production on biodiversity depends on the feedstock used and scale of production, management practices and LUC.

Intensive cultivation and use of agro-chemicals in the feedstock production for first generation biofuels can create direct threats on local biodiversity <sup>[309]</sup>. LUC resulting from increased biofuel production exacerbates the risk of losing biodiversity through the direct loss of wildlife habitats, such as tropical rainforests <sup>[11]</sup>.

Compared to first generation biofuels, second generation biofuels are considered to have fewer negative, or even positive, impacts on

biodiversity <sup>[310]</sup>. With plant-based lignocellulosic feedstocks, this is because of their long growth cycle, low requirement for fertilisers and pesticides and less human intervention during the growth period. For example, large-scale short rotation coppice willow can provide benefits for some bird species, butterflies and flowering plants <sup>[311]</sup>. Furthermore, if degraded land is used for cultivation of feedstocks, the diversity of species might be enhanced. Similarly, perennial grasslands used for biomass production may enhance avian diversity, including migratory species. However, large energy crop monocultures can be detrimental to local biodiversity, particularly through habitat loss and the expansion of invasive species <sup>[11]</sup>. Eucalyptus, switchgrass and some *Miscanthus* species exhibit some features of invasiveness <sup>[312]</sup>.

For forested areas, the most significant threat to biodiversity is deforestation. However, deforestation could also be reduced if there is a strong market for forestry products, increasing investment in forests, thus protecting and enabling them to compete with agriculture and urban and suburban development <sup>[133,313,314]</sup>. Production of biofuels from forest and sawmill residues may contribute in this way. However, conversion of natural forests to plantations, while not leading to deforestation, might contribute to habitat loss and species decline <sup>[133]</sup>. This is because natural forests generally hold a greater range of habitats and species than intensively managed plantations that have comparably low amounts of snags (standing, dead or dying trees) or coarse woody debris on the forest floor. These constitute an important niche habitat for bacteria, fungi, invertebrates, birds and mammals <sup>[315]</sup>. However, forest conversion is more likely a potential outcome of using primary forestry products and the use of forest and sawmill residues for biofuels is not likely to contribute to this. Furthermore, it should be noted that:



**Table 5**  
Acidification and eutrophication of biofuels compared to fossil fuels

Biofuel type	Feedstock	Acidification <sup>a</sup>	Eutrophication <sup>a</sup>	LCA study
First generation bioethanol	Corn	1.4 - 3	4.4 - 20	[317]
	Wheat	3	5	[187]
	Sugar beet	1.4 - 1.8	6 - 15	[200]
	Sugar cane	2	2.8	[196]
First generation biodiesel	Rapeseed	1.3-1.7	3.1-5	[217,221]
	Soybean	1.3-1.7	4-5	[175]
	Palm oil	1.3	14	[204]
Second generation bioethanol	Short rotation coppice	0.45	1.2	[246]
	Switchgrass	1.1	3.2	[255]
	Straw	1.6 - 3	2 - 3.6	[232]
Second generation biodiesel	Used cooking oil	0.2	0.63	[318]
	Jatropha	1	1	[319]
Third generation biodiesel	Algae	2.6 - 3	2.1 - 3.2	[266]

<sup>a</sup> The values represent the ratio of impacts from biofuels over fossil fuels and are dimensionless.

- the conversion of natural forests to plantation for biomass production is regulated against under the Renewables Obligation Order (ROO)<sup>[80]</sup>
- for managed forests, best management practices exist that seek to ensure that a sufficient amount of residue is left behind; for example, the Forest Europe Sustainable Forest Management Criteria<sup>[81]</sup>, compliance with which is also a key criterion for biomass produced for electricity generation under the ROO<sup>[80]</sup>.

Excessive removal of agricultural residue from fields would also be a concern as it may increase weed growth, which could lead to the increased use of herbicides and thus affect local biodiversity.

For algal biofuels, the impact on biodiversity is uncertain. The large-scale cultivation of algae can bring significant risk to coastal biodiversity through invasion of algal species of coastal shallow ecosystems, such as mud flats, salt marshes, mangroves, sea grass bed and coral reefs<sup>[309]</sup>.

Although the loss of biodiversity is identified as one of the current key environmental concerns, it is only seldom included as an impact category in LCA studies of bioenergy systems<sup>[316]</sup>. Preserving biodiversity or avoiding biodiversity loss from biofuels is one of the criteria in sustainability certification schemes. However, biodiversity loss is difficult to measure and there are no standard ways of identifying and measuring systems that promote biodiversity. In the absence of these, the ISO 13065 standard on the *Sustainability of Bioenergy* provides some guidance on the procedures applied to identify potential impacts of biofuels on biodiversity<sup>[76]</sup>.

## 7.5. Other environmental impacts

Besides the carbon footprint, other typical environmental impact categories considered in biofuel LCA studies include acidification, eutrophication, photochemical smog, human toxicity and ecotoxicity. However, the number of studies that have assessed a wider set of impact categories is still limited: of the 250 studies reviewed, only 60 such studies were found in the literature.

Because the LCA studies reviewed have used different methods to estimate the other environmental impacts, it is difficult to compare them and provide a meaningful range of impacts for different biofuels. Furthermore, the studies differ in scope, with some considering the cradle to gate and others cradle to grave system

boundary. Results of the latter studies also depend on assumptions regarding the type of vehicle. Nonetheless, several studies suggest that reduction in GHG emissions from biofuels compared to fossil fuels happens at the expense of other impacts, such as acidification and eutrophication<sup>[175,187,196,200,204,217,221,232,246,255,266,317-319]</sup>.

Table 5 compares these two impacts for different feedstocks in comparison with fossil fuels. As can be seen, first generation bioethanol has up to three times higher acidification and around three to 20 times higher eutrophication impacts. Similarly, first generation biodiesel has 30% to 70% higher acidification and at three to 14 times greater eutrophication than fossil diesel. This is mainly due to the use of fertilisers and associated emissions to air and water that cause acidification and eutrophication.

Lignocellulosic bioethanol from short rotation coppice performs better for acidification, but bioethanol from switchgrass and straw is worse than petrol for both impact categories. However, biodiesel from UCO has lower acidification and eutrophication than fossil diesel.

These two impacts are also higher for algal biodiesel than for the fossil alternative<sup>[266]</sup>. However, absence of full-scale plant data, large variability in production parameters and various assumptions lead to high uncertainty in the LCA estimates for algal biofuels<sup>[159]</sup>.

The available analyses of the voluntary certification schemes<sup>[78,79,320,321]</sup> for biofuels show that the degree to which other environmental impacts are covered by schemes varies. In relation to ISCC, the scheme currently used to certify 89% of biofuels supplied in the UK<sup>[21]</sup>, the strengths highlighted include comprehensive requirements on water management, integrated pest management, riparian vegetation and buffer zones, as well as a precise requirement for soil management. Areas suggested for improvement include the fact that environmental management systems are not explicitly required by ISCC, that the scheme has limited criteria concerning biodiversity and conservation, and that certain criteria, such as biodiversity assessments, are voluntary add-ons. These observations are based on analysis performed in 2013<sup>[78,79]</sup>. The most up-to-date comparative information appears to be provided by the International Trade Centre<sup>[322]</sup>. This suggests that environmental and social<sup>xviii</sup> management systems are now required by ISCC. Requirements on biodiversity are still limited to the mandatory criteria provided for by the RED, while other schemes, such as the RSB, require a biodiversity assessment and have a stronger set of requirements<sup>[324]</sup>.

<sup>xviii</sup> Participatory social impact assessment is required, engaging all relevant stakeholders, including local communities and indigenous people<sup>[323]</sup>.



Harvesting rapeseed crop

# 8.

## Overview of socio-economic sustainability of biofuels

### 8.1. Social impacts

Some of the critical issues surrounding the social sustainability of biofuels include food and energy security, rural development, provision of employment and labour related issues, land rights and human health issues<sup>[236,325-327]</sup>. However, although the sustainability of biofuels has been a much-debated topic in the past few years, there is still a lack of concrete evidence in the literature reviewed, regarding both their positive and negative social impacts<sup>[326]</sup>. Meanwhile, some stakeholders have highlighted negative impacts, especially impacts on developing countries (eg.<sup>[328]</sup>).

#### 8.1.1. Food security, energy security and rural development

Food security and food prices are discussed extensively in academic and other literature (eg.<sup>[109,329-334]</sup>). The key concern is the effect that the production of biofuels, particularly first generation, can have on food commodity prices through the diversion of food crops, such as corn and soybean, towards the production of biofuels. A related issue is feedstock production displacing land previously used for the cultivation of food crops. While there is a general agreement in the literature that the expansion of first generation biofuels will have an impact on agricultural commodity prices, there is little agreement on the magnitude and the relationship this has with food security<sup>[14,331,333]</sup>.

While some studies<sup>[333]</sup> claim that biofuels production has played an important role in increasing regional and global food prices, particularly during the 2007–2008 global food crisis, others project that, as long as biofuels account for a small fraction of the global transportation fuel demand (up to 10%), their impact on food supply and prices should be small<sup>[14,335]</sup>. However, the latter estimates are sensitive to the modelling approach and assumptions used, particularly those on the future volume of biofuels produced.

A review of the literature listed above highlights at least two crucial reasons why the relationship between first generation biofuels and food security is not necessarily one of direct competition:

- biofuel markets have been proposed as one mechanism that can absorb the surplus production of food-crops in normal years and provide a cushion in years of unexpected supply disruptions

## BIOENERGY PROJECTS PROVIDE OPPORTUNITIES FOR RURAL DEVELOPMENT AND DIVERSIFICATION OF FARMERS' MARKETS AND INCOMES, AND CAN THEREFORE LEAD TO INVESTMENT IN AGRICULTURAL PRODUCTIVITY AND RESILIENCE.

- bioenergy projects provide opportunities for rural development and diversification of farmers' markets and incomes, and can therefore lead to investment in agricultural productivity and resilience.

Many international organisations concerned with food security support policies or market mechanisms that allow the diversion of food crops from biofuels production to dampen volatility of food commodity prices<sup>[332,336]</sup>. This dynamic switching strategy has been demonstrated in Brazil, across their biofuels and sugar industries and has been credited in the US for stabilising commodity prices in times of drought by creating an ethanol 'supply cushion'<sup>[337]</sup>. Some therefore argue that, provided farmers and the agro-industry are free to respond, diversified markets for products can spread risk and reduce price volatility compared with narrower markets<sup>[337]</sup>. Adding bioenergy markets to existing uses of local produce can thereby increase price stability<sup>[338]</sup>.

Stakeholders consulted in the study reinforced this argument. They highlighted that by raising and diversifying farm incomes the additional demand for agricultural produce from biofuels provides assurance for farmers, who in turn have more confidence to plant food crops and invest in technologies and practices that drive higher yields. Developments in agricultural technology, plant-breeding and agricultural practices suggest that there are significant gains to be made in this area if investment can be encouraged.

Given the overlapping feedstocks, investments in the infrastructure and technology required for food production, processing, storage and distribution also overlap with biofuels production. Investments in Brazilian bioethanol industries have supported spin-off benefits for neighbouring productive sectors and local economies in rural areas where biomass and labour are abundant, but infrastructure was previously limited<sup>[338]</sup>. One of the most pervasive recommendations for improving food security is to invest in rural agricultural technology and infrastructure, driving up productivity and efficiencies<sup>[339,340]</sup>. There is an argument that the development of bioenergy (including liquid biofuels) can help drive such investment (provided the right flexibility through either policy or market mechanisms); yet most analyses of bioenergy development have been carried out independently of the development of food systems<sup>[341]</sup>; this suggests that further research on these potential benefits is required.

In their review of the topic, Ecofys<sup>[331]</sup> note some additional factors in determining the relationship between biofuels, primary agricultural commodity prices and food security:

- Prices of primary global agricultural commodities (from which biofuels are produced) are not directly correlated to food prices (this is in contrast to some other literature<sup>[14,333]</sup>). Local food markets are often disconnected from global markets and commodity costs are often only a small component of final food production costs.
- Protein rich co-products from ethanol and biodiesel production can avoid production and the associated land use elsewhere.
- Agricultural commodity prices are strongly linked to the oil price. The production of biofuels could reduce oil prices and as such limit future commodity price increases.
- Systemic factors, like reduced reserves, food waste, speculation, transportation issues, storage costs and problems and hoarding play a much larger role in local food prices.

The use of non-food energy crops for biofuel production does not hold the same concerns related to food production (but may also lack the potential benefits discussed above). Nevertheless, there may still be conflict if feedstocks are grown on land suitable for food production. However, feedstock production on set-aside, marginal land and sustainable use of agricultural residues, forest and sawmill residues and wood wastes can prevent these negative effects<sup>[320,326]</sup>. There are, however, concerns over the availability and use of such land, considering the need for high feedstock yields to ensure economic viability. Furthermore, the set-aside land could also be used for food production, leading to competition with biofuels. There is also an ongoing debate on how marginal land is defined in different locations and over time<sup>[342]</sup>.

The assumption of no effects on food prices, land use or other aspects from using residues and waste products holds true only when feedstocks would genuinely otherwise be disposed of. For this reason, it is also important to hold under review any emergent alternative uses for feedstocks currently considered a waste. For example, tallow has alternative uses in animal feed, food and pet food (as well as for oleo-chemicals and soap production) and studies have identified indirect displacement effects where alternative users are forced to seek substitutes; for this reason, the UK only



## ANALYSIS CONDUCTED BY ECOFYS IN 2013 CONCLUDED THAT THE UK BIOFUEL INDUSTRY SUPPORTS 3500 JOBS ACROSS PRODUCTION, SUPPLY AND DISTRIBUTION, BUT NOT INCLUDING FEEDSTOCK COLLECTION ACTIVITIES. THEY FOUND THAT THE NINE LARGEST COMMERCIAL-SCALE BIOFUEL PRODUCERS DIRECTLY EMPLOYED 517 PEOPLE BUT THAT ADDITIONAL JOBS IN, FOR EXAMPLE, FARMING, TRANSPORT AND DISTRIBUTION, WERE SUPPORTED BY THE INDUSTRY.

offers double-counting to Category 1 tallow (used for purposes of energy generation only) and is monitoring effects on the price and availability of other categories<sup>[343]</sup>. As other feedstocks defined as wastes are utilised for biofuel production, they should be subject to similar ongoing scrutiny.

The use of domestically produced biofuels can potentially improve national energy security and reduce risks related to exposure to fossil-fuel markets. However, the role of biofuels in this respect has been so far limited because of its relatively small share in transport fuels. Moreover, due to an expected high reliance on imported biofuels in the future and the susceptibility of feedstock supply to weather conditions, biofuels are unlikely to contribute significantly to the long-term energy security of the European Union<sup>[344]</sup>. This may also apply to second generation biofuels in the UK as the level of achievable supply of UK-sourced feedstocks remains open to question.

### 8.1.2. Employment, labour-related issues and land rights

Analysis conducted by Ecofys<sup>[26]</sup> in 2013 concluded that the UK biofuel industry supports 3500 jobs across production, supply and distribution, but not including feedstock collection activities. They found that the nine largest commercial-scale biofuel producers directly employed 517 people but that additional jobs in, for example, farming, transport and distribution, were supported by the industry. An evaluation by the Renewable Energy Association, based on the levels of investment planned at the time (2013) suggests that the employment figure could rise from 3500 to over 6000 by 2020<sup>[345]</sup>.

Ecofys<sup>[26]</sup> also considered job opportunities related to collection of one particular feedstock – UCO. It found that these vary widely depending upon the labour intensiveness of collection, location of the UCO (urban or rural areas) and its source (food manufacturers, restaurants or households) but that there could be several thousand jobs in the UK related to collection of UCO alone.

It is not possible to indicate where in the EU waste and residue feedstocks might be most effectively mobilised. However, the NNFFCC<sup>[346]</sup> predict that if all of the resource was utilised, between 56,000 and 133,000 additional permanent jobs in EU agricultural and forestry sectors might be created, along with 4000 and 13,000 additional permanent jobs in plant operation and 87,000 to 162,000 temporary jobs in plant construction phase. This would represent a net value of between €0.2 and €5.2 billion to the EU's

rural agricultural economy and between €0.7 and €2.3 billion to the EU's rural forest economy<sup>[346]</sup>. It should be noted that, in reality, competition will be high from the heat and power sector, and utilisation is unlikely to take off in all regions. Furthermore, reaching this scale would require a sharp increase in investment<sup>[52]</sup>.

In the same way that it can be argued that first generation biofuels can diversify markets for agriculture, the development of second generation biofuels might similarly bolster other sectors. For example, forest and sawmill residues and wood wastes for second generation biofuels are gaining attention in Norway, Sweden and Finland owing to a scale of resources and current employment in the forestry sector, which is currently facing declining markets<sup>[347]</sup>. In Norway, approximately 24% of the total land area is covered by productive forests, with forestry providing employment for 4000 people, the sawn-wood industries 16,000 and the pulp and paper sector 6500 people<sup>[348]</sup>. Yet, European paper demand declined by about 20% in the period from 2007 to 2012; in the US, demand for office paper fell by 40% and newsprint by 60% in the period 2001 to 2011<sup>[349]</sup>. Use of forest and sawmill residues and wood wastes as feedstocks for second generation biofuels might utilise the existing harvesting and transport infrastructure while diversifying the market for an existing industry with significant existing human capital associated with it<sup>[347]</sup>.

As with many other international supply chains, when importing products, labour-related issues, such as child and forced labour, health and safety and low wages, are a concern. Target-based policies, such as those contained in the RED, were initially criticised for contributing to human rights violations by incentivising producers to scale up production quickly and in the easiest way possible, often moving into countries with less rigorous regulatory environments<sup>[350]</sup>. While voluntary certification schemes have become more established since these policies were first introduced, more recent analysis maintains that concerns still apply to feedstock production for biofuels in many countries<sup>[351]</sup>. Furthermore, while the RED refers to the need to avoid such issues, this is not mandatory. Instead, it mandates biennial reports on the social sustainability impacts of biofuels in the EU and in developing countries, and the impact of EU biofuel policy on the availability of affordable foodstuffs. The ECA considers these reports to contain only limited information and insufficient data to draw clear conclusions<sup>[5]</sup>. Furthermore, biofuel feedstock expansion is, in some countries, associated with unfair practices in land acquisition and displacement of customary livelihoods resulting from large-scale land transfer to investors<sup>[326,352]</sup>, raising the issue of land acquisition



Tailpipe exhaust emissions

and land rights. This is a concern particularly in countries where land ownership is not secure. The establishment of large-scale biofuels feedstock production can also cause smallholders, tenants and herders to lose access to productive land<sup>[353]</sup>.

### 8.1.3. Air quality and human health issues

Production and use of biofuel generate emissions of various air pollutants, including particulate matter (PM), carbon monoxide (CO), nitrogen oxides (NO<sub>x</sub>), hydrocarbons and volatile organic compounds (VOCs). Unburned hydrocarbons, VOCs and NO<sub>x</sub> are precursors for the formation of smog and ground-level ozone. These pollutants are associated with increased morbidity and mortality from cardiovascular and respiratory diseases and certain cancers<sup>[327,354]</sup>. Air quality modelling studies show that life cycle emissions of some pollutants may be higher for biofuels when compared to fossil fuels, largely resulting from the emissions associated with feedstock production and biofuel processing<sup>[327,355]</sup>. For example, in the case of sugar cane ethanol in Brazil, burning of straw in fields is the common practice in certain areas and is the predominant source of PM<sup>[327,355]</sup>. Studies on health impacts of sugar cane ethanol in Brazil suggest that there is strong evidence that burning straw in sugar cane fields causes substantial respiratory diseases, such as asthma and pneumonia, in sugar cane field workers and local populations<sup>[327,355-358]</sup>. However, as mentioned in section 7.1.1, our consultation with Brazilian experts suggested that the practice of pre-harvest burning is being phased out.

Vehicular exhaust emissions of bioethanol blends vary with blend strength. Consistent testing of vehicular emissions is also a significant challenge since they are affected by many different parameters, including the type of engine and how it is run (the operational drive cycle), vehicle age and maintenance, the quality of the base fuel and exhaust after treatment<sup>[359]</sup>. However, in general, lower bioethanol blends (E5 to E15) have lower CO and PM emissions compared to petrol<sup>[359,360]</sup>. Beer et al.<sup>[360]</sup> suggest that lower PM emissions from low-ethanol blends used in spark-ignition vehicles have slight health benefits over petrol. However, they lead to significantly higher emissions of acetaldehyde, which is one of the precursor VOCs involved in ground-level ozone formation. Similarly, higher ethanol blends (E85) lead to comparable, or slightly lower, levels of PM, NO<sub>x</sub> and CO emissions than petrol, but five to 10 times higher acetaldehyde emissions<sup>[359,361,362]</sup>.

Compared to fossil diesel, biodiesel has generally lower exhaust emissions of PM, CO, hydrocarbons and VOCs, but higher NO<sub>x</sub>

emissions<sup>[363,364]</sup>. These differences are small for 5% to 20% biodiesel blends and would lead to negligible or non-measurable impacts on air quality<sup>[363]</sup>, but increase with higher blends<sup>[359]</sup>. On the other hand, Larcombe et al.<sup>[365]</sup> argue that, despite having lower PM emissions, biodiesel exhaust emissions could potentially be more harmful to human health because of higher proportion of ultra-fine particles (<100 nm diameter) compared to diesel exhaust. This is due to the fact that smaller particles remain suspended in the air for longer, are more easily inhaled and are able to penetrate more deeply into the lungs. However, other assessments on the potential human health implications of biodiesel suggest that the use of biodiesel fuel blends compared to fossil diesel results in minimal changes in health impacts<sup>[363,364]</sup>. Thus, the topic of human health impacts from biofuels remains open to debate, requiring further research and evidence.

Besides air pollution, production of liquid biofuels could affect human health directly through water and soil pollution and occupational hazards<sup>[327]</sup>. However, these effects are scarcely discussed in the literature and should be explored further to understand whether there are risks that need to be addressed.

### 8.1.4. Further considerations

Ultimately, as with other sustainability considerations, social impacts of biofuel supply chains depend on the biophysical and socio-economic conditions of the production region and the characteristics of the supply chains, such as types of energy crop, conversion technologies, logistics, etc. Despite the concerns, in existing literature social aspects tend to appear in the form of a checklist of generic social criteria rather than appraisal of real or potential social impacts of biofuels. Furthermore, as mentioned previously, within the RED, sustainability criteria for biofuels cover social aspects in a limited way and their further development thus relies mainly on voluntary certification schemes.

One of the reasons for the social sustainability of biofuels not being assessed more widely and systematically is the lack of an internationally agreed methodology on how these issues could be quantified and evaluated. Many approaches for assessing social sustainability exist in the literature, but few are specific to biofuels, with a notable exception of the RTFO methodology<sup>[366]</sup>. It is also possible to assess the social sustainability of biofuels using a life cycle approach and applying the social LCA (S-LCA) methodology<sup>[367]</sup>. However, this is a complex method with over 190 social indicators, raising concerns over practicality of

# THERE ARE TWO GENERAL AREAS WHERE POTENTIAL FOR FRAUDULENT ACTIVITY EXISTS: WHERE AN OPERATOR COULD CLASSIFY AS WASTE OR RESIDUE SOMETHING THAT IS NOT (OR WAS ADULTERATED), OR WHERE AN OPERATOR MAY ATTEMPT TO GET THE SAME DOUBLE-COUNTED PRODUCT CERTIFIED TWICE BY DIFFERENT VOLUNTARY SCHEMES.

implementation. Instead, some stakeholders consulted in this study argued that a semi-quantitative risk approach would provide a sound and more practicable basis for such assessments<sup>[368]</sup>.

Some also highlighted that there are high risks of negative social impacts of both fossil and biofuels and considering social criteria only for biofuels can be seen as an unfair advantage for fossil fuels, since additional investments and other costs are involved in meeting those criteria<sup>[351]</sup>.

## 8.2. Economic impacts

Economic indicators used to evaluate the commercial viability of biofuel projects include capital and operating costs, price of feedstocks, return on investments, fixed and variable costs, life cycle costs and biofuel and fossil fuel prices<sup>[369]</sup>. Other indicators, such as contribution of biofuels to gross domestic product (GDP), changes in fossil energy prices, changes in food prices relative to biofuel production and employment levels, are used at a national level to monitor the contribution of biofuels to the economy. Some of these indicators are discussed below.

### 8.2.1. Competitiveness with fossil fuels

The global biorefinery products market has been valued at £262 billion in 2014 and is expected to grow by 14% per annum to 2020<sup>[56]</sup>. However, biofuels are not currently competitive with fossil fuel equivalents, although this depends upon the prevailing price of crude oil. Specifically, in Europe, ethanol from grain and sugar beet and first generation biodiesel are not competitive on price with petroleum fuels on an equivalent energy-content basis<sup>[370]</sup>. In 2013, the wholesale price of bioethanol in Europe was €27.7/GJ (€0.59/litre), more than double the price of petrol (€13.1/GJ or €0.43/litre). A similar differential applied to the wholesale prices of biodiesel compared to fossil diesel: €25.7/GJ (€0.85/litre) vs €12.9/GJ (€0.47/litre)<sup>[344]</sup>. By 2020, the wholesale price of bioethanol in Europe is estimated to be €14.3/GJ higher than petrol and €11.7/GJ for biodiesel<sup>[344]</sup>. Similarly, in the US, ethanol remains more expensive than gasoline on an energy equivalent basis, but the price gap between the two has decreased in recent years<sup>[14]</sup>. Brazilian ethanol from sugar cane is more competitive than US ethanol but, at low oil prices, it is still more expensive than petrol in Brazil.

Given this lack of price competitiveness, biofuels markets tend to be highly dependent on policy for their creation. In the UK, the market

is reliant on the blending obligation in place under the RTFO. Biofuel producers consulted as part of this study reported that they would not be able to produce and supply even a single litre of biofuels beyond the mandated quantity since it would not be economically viable. Therefore, any increase in the amount of biofuels supplied would need to be driven by an increase in the blending obligation or some other similarly strong policy incentive.

Although for legitimate sustainability concerns, the obligation has not increased above 4.75% and investors have been badly hit as expected increases in the obligation have not been forthcoming. Further investment in the sector will not occur unless investors have confidence that policies will drive expansion of what is currently a stagnant market.

The evidence reviewed indicates that the UK should be able to meet an increase in the blending obligation in line with current targets set out in the RED because:

- existing first generation biofuel plants in the UK are currently operating below capacity
- producers, supported by the available surveys on resource availability, have reported that they can expand production from existing waste feedstocks, such as UCO, tallow and MSW
- expansion in the market would provide producers of fuels from waste lignocellulosic feedstocks, such as agricultural residues, forest and sawmill residues and wood wastes, with the market necessary to bring these fuels online.

### 8.2.2. Costs of producing biofuels

Biofuel production costs can vary widely by feedstock, conversion process, scale of production and region. However, in general, for first generation biofuels, the capital costs account for a relatively small proportion of total production cost. Annualised capital costs are estimated at 4% for biodiesel plants and 10% for bioethanol plants<sup>[344]</sup>. On the other hand, the cost of feedstock is a major factor in the viability of biofuel production, generally accounting for 60% to 90% of the total operating costs of first generation biofuels<sup>[14]</sup>.

Compared with first generation biofuels, the capital costs of second generation biofuels account for a higher share of overall costs, while the feedstock costs are significantly lower. Feedstocks for cellulosic biofuels are expected to range between 30% to 45% of total production costs in the long term<sup>[371]</sup>. Therefore, second generation





Cooking oil to be recycled into biofuel

biofuels will likely be less sensitive to variations in feedstock prices. However, high capital costs is the significant barrier for their deployment<sup>[372]</sup>. With potential improvements in conversion efficiency and capital cost reduction, the production costs for future second generation biofuels could become competitive, provided oil price is above US\$100 per barrel; however, if it falls below US\$80 per barrel, second generation biofuels are very unlikely to be able to compete directly with gasoline and diesel over the next 30 years<sup>[8]</sup>.

Besides large uncertainties over technical feasibility and environmental benefits, there are significant questions over the economic viability of third generation biofuels as costs associated with the production from microalgae are very high<sup>[292,297]</sup>. Depending on the techno-economic studies and the underlying technological options, the prices for crude biodiesel from microalgae have been estimated between 3 and 30 US\$ per litre<sup>[372]</sup>. Literature also suggests that without considerable improvement in current production technologies<sup>[269]</sup> and identification of better means for utilisation of co-products<sup>[286]</sup>, algal biodiesel cannot provide a sustainable alternative to fossil diesel. However, the costs could fall in the future as technology improves and production expands.

### 8.2.3. Cost of waste feedstocks and potential for fraud

One concern particular to second generation biofuels is the weak verification of the origin of wastes and residues used for their production and the potential for fraudulent activities. As noted previously, a recent audit by the ECA found that the European Commission recognised schemes that did not have appropriate verification procedures to ensure that the origin of biofuels

produced from waste was indeed waste and did not assess whether voluntary schemes verify the origin of waste used as feedstocks.

There are two general areas where potential for fraudulent activity exists: where an operator could classify as waste or residue something that is not (or was adulterated), or where an operator may attempt to get the same double-counted product certified twice by different voluntary schemes<sup>[5]</sup>. While low prices for UCO and tallow significantly reduce the total production cost of biodiesel<sup>[370]</sup>, the double-counting mechanism within the RED has led to situations where UCO biodiesel is traded at a higher price than biodiesel from vegetable oil<sup>[373]</sup>. This carries the risk that virgin oil is adulterated in order to be traded as UCO for biofuel production<sup>[374]</sup>. Given concerns over the verification of wastes or residues, the possibility that virgin oils or fraudulently denatured virgin oils are being used to produce biofuels cannot be ruled out. Measures to monitor and prevent fraud have been discussed by EU member states. However, discussions were deferred as it was felt that only the Commission had the legitimacy to lead on the issue<sup>[5]</sup>.

Concerns over fraud were echoed in our stakeholder consultation. This was not just in relation to UCO but also other wastes and residues for which the production of second generation biofuels creates a market (or might do so in the future). Even where fraud is controlled, stakeholders still expressed concerns regarding potential reinforcing effects that incentivise the creation of 'wastes'; for example, discarding misshapen potatoes when their best use may still be for use as food or feed.



# 9.

## Summary of findings and recommendations for improvements

The primary aim of this study was to assess the potential of liquid biofuels to contribute towards reducing GHG emissions from transport while satisfying other relevant sustainability criteria. In relation to this, the following should be considered:

- If the UK is to meet its climate change mitigation targets, it must pursue all available technological options for decarbonisation. As liquid fuels are expected to continue to play a key role in the foreseeable future in road transport, shipping and aviation, all efforts should be made to further the sustainable production of biofuels.
- However, biofuels should not be considered in isolation and must be integrated carefully within the wider and rapidly changing UK and global energy systems. The competing factors, such as hydrogen, energy storage, etc., should be considered alongside the drive to develop biofuel markets.
- Liquid biofuels are dependent on markets created by government policy. It was clear from evidence gathered during the study that, without obligations or subsidies for the use of biofuels, they would not be able to compete on the open market, particularly while the price of oil remains low.
- Currently, in the UK, biofuels policy is driven by EU Directives in terms of both the amount used and sustainability criteria. Following the result of the EU referendum in June 2016, the UK will need to decide upon its national policies and their relationship to EU biofuels directives and regulations. Until the UK actually leaves the EU, it will continue to follow these regulations. Hence, this study has been carried out in this context. It should also be noted that supply chains for both biofuel feedstocks and biofuels are global. Should the UK change, the sustainability standards applicable in the UK following its exit from the EU, it is likely that producers will continue to adhere to the standards applicable to their most dominant markets.

This section provides a summary of the findings of the study and recommendations for future improvements in key aspects addressed in the study. These have been used to guide policy recommendations set out in section 10.

## SECOND GENERATION BIOFUELS HAVE A GREATER POTENTIAL THAN FIRST GENERATION TO REDUCE GHG EMISSIONS, ASSUMING NO LAND USE CHANGE. HOWEVER, THE DEVELOPMENT OF SECOND GENERATION BIOFUELS WILL TAKE TIME AND IS LIKELY TO DEPEND ON THE CONTINUED SUPPORT OF FIRST GENERATION FUELS TO GIVE THE INDUSTRY THE CONFIDENCE TO INVEST.

### 9.1. Improving the evidence base

All liquid biofuels must meet various sustainability criteria, in the EU and UK regulated by the RED<sup>[15]</sup> and RTFO<sup>[18]</sup>, respectively. One of the criteria is the requirement for biofuels to have at least 50% lower carbon footprint than their fossil fuel alternatives, rising to 60% lower for biofuel plants commencing operation after 1 January 2018. LCA is used as a tool to estimate the carbon footprint of biofuels. However, as demonstrated in this study, the estimates in LCA vary widely among the studies owing to a wide range of methodological choices in LCA and various uncertainties. Thus, it is important to understand both the utility and the limitations of LCA, as summarised below.

#### 9.1.1. Life cycle assessment

##### Summary of findings

1. LCA is a complex tool that lies at the interface between science, engineering and policy. Despite this complexity, it is often perceived as a tool that can give a definitive answer to multifaceted questions. As the findings in this report demonstrate clearly, there are no definitive answers - the outcomes of LCA studies are highly situational and dependent on many factors, including goal of the study, assumptions, data, models, methodology and tools used. It is important to recognise this and interpret the results accordingly. Furthermore, some mechanisms to communicate complexity to policy makers as well as to the public are needed.
2. Two types of LCA are used for appraisal of the carbon footprint and other environmental impacts of biofuels: attributional (ALCA) and consequential (CLCA). The former is generally applied to specific biofuel supply chains, attributing the impacts to different activities within that supply chain. CLCA evaluates potential indirect consequences of biofuels by considering various 'what if' scenarios that could arise due to biofuels. ALCA is well established and can help drive greater efficiency in supply chains, while CLCA is still under development and is more suited for guiding policy decisions. Most of the studies so far have followed the attributional approach.
3. An important aspect to keep in mind when considering LCA studies is that each will have a specific goal and scope. This could include assessment of the carbon footprint and other environmental impacts of a particular biofuel, comparison to conventional fuels or optimisation of a supply chain. The goal and scope of the study will in turn drive the choice of key methodological aspects, such as definition of system boundary, functional unit, allocation methods and data collection. As a result, no two LCA studies are exactly equivalent and great care must be taken when comparing results.
4. For the above reasons, the carbon footprints of biofuels estimated in the reviewed LCA studies range widely. Despite this, the existing evidence base is instructive. Firstly, it shows that first generation biofuels can - on average - meet the required GHG emissions savings if no LUC is involved and should continue to play a role as transport fuels. Secondly, in general, second generation biofuels have a greater potential than first generation to reduce GHG emissions, assuming no LUC. However, the development of second generation biofuels will take time and is likely to depend on the continued support of first generation fuels to give the industry the confidence to invest. It is also clear from the evidence gathered that, even under optimistic conditions, third generation biofuels from algae are unlikely to make a contribution to the transport sector; they are unproven and expensive to produce and, as such, the algal feedstock will continue to be restricted to high-value markets, such as cosmetics and dietary supplements.
5. In both ALCA and CLCA of biofuels, a number of key uncertainties remain. These include methodological, data and model uncertainties, with most significant uncertainties related to:
  - models for estimating direct and indirect land-use change
  - extent and duration of changes in soil and vegetation carbon stocks
  - soil nitrous oxide emissions.
6. There is debate on what role CLCA should play beyond informing national and EU policy on the environmental sustainability of biofuels and whether it should be integrated into the overall assessment and sustainability certification of biofuels. Stakeholder engagement initiatives have failed to reach a consensus view on this<sup>[9]</sup> and this was reflected in differing views expressed during stakeholder consultation for this study. While all stakeholders recognised the limitations of ALCA, some argued that environmental assessment of biofuels should be based exclusively on the direct impacts from the biofuel supply chains



# IMPROVEMENTS FOR CONSEQUENTIAL LIFE CYCLE ASSESSMENT (CLCA) INVOLVE BOTH METHODOLOGICAL AND PRACTICAL ASPECTS. FURTHER WORK IS REQUIRED TOWARDS THE STANDARDISATION OF CLCA METHODOLOGY. THERE IS A NEED TO IMPROVE DEVELOPMENT OF COUNTERFACTUAL ('WHAT IF') SCENARIOS AND THE INDIRECT LAND-USE CHANGE (ILUC) MODELS.

and that the ISO 14040/44 methodology is adequate for these purposes. The argument for this is that there are simply too many uncertainties in quantification of indirect effects and biofuel producers can only be expected to assume responsibility for their own actions and the sustainability of their supply chain; they cannot address global trends in LUC and/or food security in an unrelated location elsewhere in the world. This is also recognised by the new ISO 13065 standard on *Sustainability Criteria for Bioenergy*. Instead, global food security and ILUC are macro-economic issues that should guide the development of biofuels policy and cannot be devolved to individual producers.

## Recommendations for improvements

While being originally a static tool, LCA is increasingly being stretched to answer dynamic questions. To increase its utility as an evidence-based tool for evaluating the environmental sustainability of biofuels, both ALCA and CLCA need to be improved, as follows:

1. The main improvements required for ALCA are related to its application in practice, with the need for studies to follow the ISO 14040 and 14044 standards<sup>[71,72]</sup> more rigorously. Among other requirements, these standards require clear definition of goal, scope, functional unit and allocation methods. However, in many of the reviewed studies these were often omitted or unclear, preventing accurate interpretation of the results and any cross-comparisons with other studies. Thus, a clear statement in LCA studies of the goal, scope and methods used is required following the guidance in the ISO standards, if the findings are to be useful and comparable to other studies.
2. Improvements for CLCA involve both methodological and practical aspects. For the former, further work is required towards the standardisation of CLCA methodology. As part of that, there is a need to improve development of counterfactual ('what if') scenarios and the ILUC models. Involvement of multiple stakeholders can help to build consensus on the definition of the scenarios and to improve the transparency of ILUC models, their assumptions and the associated uncertainty. Examples of stakeholder involvement to achieve these goals include the GLOBIOM<sup>[118]</sup> and E4Tech<sup>[170]</sup> studies. However, ILUC models and scenarios will always contain a significant degree of uncertainty. Nevertheless, they can still be used to provide a measure of risk associated with biofuels expansion.
3. In addition to improving the CLCA methodology, much work is required in its application in practice. Specifically, there is a

need to validate ILUC models with empirical evidence; empirical methods to test alternative hypotheses also require attention. These will take some time to be developed and implemented but in the meantime CLCA can still play an important role at a policy level to help improve the methodology and practical applications, including its use for:

- analysing and evaluating scenarios containing alternative policy options
  - identifying and appraising high-impact policy levers and barriers to further development of biofuels
  - informing discussion between policy-makers, analysts and stakeholders.
4. Further work is needed on the development of models and empirical evidence of changes in soil and plant carbon stocks as well as emissions of nitrous oxide related to the application of fertilisers. Research is also needed on estimations of biogenic carbon, particularly changes in the forest carbon stock that may be affected by an increase in biofuels demand. The assessment of the balance of biogenic carbon emissions from forest bioenergy systems needs to be based on long-term, landscape-level modelling and integrate the characteristics of expected demand, forest structure, climate and forest industry profile.
  5. Common problems in LCA include lack of transparency and data variation and gaps. Yet, the reliability and correct interpretation of LCA results depend crucially on these factors. Therefore, improving transparency, data availability and sharing are key if LCA is to be trusted and useful for policy. This could be achieved through development of open national and global databases, in a similar way that national inventories have been developed for GHG reporting under the Kyoto Protocol.
  6. All LCA studies should include uncertainty and sensitivity analyses to quantify the effect of key parameters and assumptions and identify confidence intervals or probability distribution of the results. Such analysis would make the reliability of the findings easier to evaluate and would give more confidence in any policy or decision making based on these studies.



Biofuels distribution

## 9.2. Robust auditing of sustainability

LCA and wider sustainability assessments are of little use if the results cannot be trusted. Therefore, strong auditing of biofuel supply chains is vital. International standards such as ISO 13065<sup>[76]</sup> are valuable in setting out key guiding principles and criteria and should be kept up-to-date as understanding of the issues involved develops. Certification schemes have a key role to play and are already regarded as having contributed to the sustainability of biofuels.

### Summary of findings

1. Currently there are 19 voluntary certification schemes recognised by the European Commission as meeting the requirements under the RED and can be used to certify biofuels. All schemes implement RED mandatory minimum requirements. However, they vary significantly in intention, geographical coverage, scope, organisation and governance and can apply both stricter and additional criteria beyond the RED. As a consequence, some schemes are compliance-based, covering RED requirements only, while others contain more comprehensive sets of environmental and social criteria.
2. In a recent study, the European Court of Auditors found that the EU certification system is not fully reliable and member states can report as sustainable biofuels whose sustainability has not been verified<sup>[5]</sup>. This finding is of significant concern. However, it was based on an analysis of the Commission's process for scheme recognition and should not be interpreted as if the schemes themselves are not fit for purpose. Indeed, many stakeholders consulted as part of this study argued that biofuel sustainability schemes have had a wide impact, improving sustainability standards across the whole agricultural sector. Nevertheless, closer scrutiny of the schemes is required and the recommendations for improvements are outlined below.

### Recommendations for improvements

1. Measures should be taken to ensure that all certification schemes account for any significant negative socio-economic effects. The European Court of Auditors recommends that the Commission should require voluntary schemes to report any relevant information once a year based on their certification activities<sup>[5]</sup>. Given that some certification schemes currently omit important potential social impacts, this is likely to be insufficient. As some existing schemes do cover socio-economic effects comprehensively, it may be necessary to require the use of these schemes. Alternatively, since producers appear to be predominantly compliance-driven, the broadening and strengthening of the schemes across the board might be achieved by expanding the mandatory criteria in the RED.
2. The weak verification of the origin of wastes and residues used for second generation biofuels and the potential for fraudulent activities is another key concern. In October 2014 the European Commission acknowledged that voluntary schemes were not providing sufficient evidence of the origin of waste and addressed a guidance note to all recognised schemes suggesting they develop specific auditing procedures covering the origin of waste and residues<sup>[373]</sup>. Furthermore, the latest package of policy proposals from the Commission includes the introduction of national databases to ensure traceability of the fuels and to mitigate the risk of fraud. These are welcome measures that need to ensure traceability and verification is strengthened.
3. More generally, the transparency and governance of some schemes needs to be strengthened. The available analysis has found that the transparency of governance is greater for those schemes that are based on 'open' membership. Schemes that include different stakeholder groups in their managing bodies, such as producers, traders, environmentalists and





Bioethanol plant

researchers, have more balanced decision-making processes, more comprehensive development of the schemes' standards and wider supervision of their implementation.

4. It is also necessary to use a means to detect and resolve alleged infringements of schemes' rules or to verify that complaints are registered and appropriately acted upon.
5. Requiring stronger adherence to the ISEAL Alliance standard, which covers some of the key issues highlighted above, such as scheme governance, could be an effective way of strengthening biofuels certification.

### 9.3. Developing a risk-based approach

#### Summary of findings

1. Any policy on sustainability of biofuels should ensure that risks from their production and consumption are minimised along the supply chains. Thus, developing a risk-based approach to identifying sustainable biofuels is appropriate. The aim of a risk-based approach is to promote low-risk feedstocks and biofuels

while strongly disincentivising high-risk alternatives. For example, feedstocks that result in either deforestation or drainage of peat lands are considered high risk and should be avoided.

2. To develop a risk-based approach, it would be necessary to gain empirical evidence for the emission trends for a particular feedstock in a particular location or region. Existing evidence reviewed in this study provides a foundation for achieving this and there is already a degree of geographical granularity in the information available. For example, as part of determining what feedstocks are eligible for use of RED default values<sup>ixx</sup>, the so-called NUTS 2 report<sup>[375]</sup> presents total cultivation emissions for each biofuel feedstock by UK region. Although the report does not include an analysis of GHG emissions associated with ILUC, the general conclusion is that significant portions of UK arable crops represent low-risk feedstocks for first generation biofuels in terms of carbon emissions. Scrutiny of similar analysis, required by the European Commission across member states, provides a solid foundation for the identification of low-risk biofuels feedstocks.

<sup>ixx</sup> Annex V of the EU RED contains carbon defaults for the estimation of GHG emissions for a number of biofuel feedstocks. These defaults are made up of three components, or disaggregated defaults: for cultivation, processing and transport. For feedstocks grown in the EU, the use of default values to report GHG emissions is only permitted if the emissions arising from cultivation in the region where the crop was grown have been shown to be typically less than, or equal to, the disaggregated default for cultivation values. For areas where estimated emissions exceed these values, actual values for cultivation must be used in GHG emissions calculations. Article 19(2) of the EU RED seeks to identify those areas of the EU where typical GHG emissions from the cultivation of raw materials can be expected to be less than or equal to the disaggregated default for cultivation used in the default values in EU RED; each member state had to identify these areas and report to the Commission by 31 March 2010.



## THERE ARE MANY LAND-USING SECTORS THAT ARE CURRENTLY NOT SUBJECT TO THE SAME LEVELS OF SUSTAINABILITY GOVERNANCE AS BIOFUELS BUT THAT HAVE SIMILAR SUSTAINABILITY CONCERNS.

3. In addition to this, key findings from ILUC studies to date support the following:

- a cap on first generation biofuels would reduce overall LUC emissions owing to increased share of second generation biofuels with low or negative emissions
- greater utilisation of marginal or abandoned land in the EU for biofuel production could reduce LUC emissions; this is a particularly good policy option if the land is degraded and soil-carbon stocks are restored through use
- effective measures to prevent deforestation and peat land drainage could reduce the LUC emissions associated with first generation biofuels.

### Recommendations for improvements

1. Further development of risk-based approaches to biofuels according to feedstocks type and geographical source would assist in developing a more granular set of incentives that better manage the risks presented by some of the higher-risk feedstocks. As already discussed, this needs to be combined with a strengthening of sustainability demonstration at a local level through auditing feedstock production.
2. Important steps have already been made to develop precisely the kind of risk-based approach that we advocate. Specifically, the DfT are proposing changes to the RTFO, including<sup>[376]</sup>:
  - set a maximum level for the supply of crop based biofuels to mitigate the risk of an increase in their supply and associated ILUC impacts (a much lower maximum level than the 7% proposed for the RED)
  - introduce a sub-target for particular advanced, or 'development', fuels derived from specified wastes/residues (in the terminology of this report, second and third generation biofuels)
  - define wastes to meet the definition used in the RED and ensure that wastes eligible for additional reward are genuine wastes (to be achieved by incorporating the waste hierarchy concept set out in the Waste Framework Directive into the RTFO)
  - maintain double rewards under the RTFO, to incentivise the production of fuels made from wastes that meet the new definition and the hierarchy.

Based on the body of evidence reviewed and presented through stakeholder consultation, this study finds all of these steps to be constructive in the development of an appropriate, risk-based approach to biofuels policy.

## 9.4. Integrated management of ecosystem services

### Summary of findings

1. Biofuels are part of much wider systems of land use in the UK and elsewhere. This means that a key part of policy development should be to consider biofuels as part of integrated management of ecosystem services at the landscape and water catchment levels.
2. There are many land-using sectors that are currently not subject to the same levels of sustainability governance as biofuels but that have similar sustainability concerns. A significant number of stakeholders consulted voiced concerns over piecemeal approaches to ILUC through biofuels policy rather than through wider policies for land-based industries; in effect that we should not "seek to change the world through biofuels policy".

### Recommendations for improvements

1. Work is needed to strengthen sustainability governance across all land-based supply chains for the following reasons:
  - both fossil and biofuels have the potential for negative social impacts
  - controlling ILUC impacts depends on wider agricultural and forestry policy
  - social impacts depend on social policies at a national level (eg. labour laws)
  - bioenergy sustainability criteria can help set high level standards at project level in agriculture and forestry and mitigate residual risk
  - relative to many other land-uses, biofuels sustainability reporting and governance can be seen as relatively strong and the introduction of firmer criteria or governance within solely the biofuels sector is unlikely to curb some of the key sustainability issues

## APPLYING A SYSTEMS APPROACH TO SUSTAINABILITY GOVERNANCE ACROSS ALL LAND-BASED SECTORS WOULD NOT ONLY HELP TO IMPROVE ECOSYSTEM SERVICES BUT WOULD ALSO ENSURE THAT BIOFUELS ARE NOT BEING TREATED UNFAIRLY RELATIVE TO OTHER SECTORS OR THAT PROGRESS MADE IN THIS SECTOR IS NOT UNDONE BY EXPANSION OR UNSUSTAINABLE PRACTICES IN OTHERS.

- many stakeholders who engaged with this study reported the need for, as a minimum, stronger sustainability reporting requirements across other land-based sectors, which would also benefit from the experience from the biofuels sector (eg. LCA methods, voluntary schemes and standards, etc.)
  - applying a systems approach to sustainability governance across all land-based sectors would not only help to improve the ecosystem services but would also ensure that biofuels are not being treated unfairly relative to other sectors or that progress made in this sector is not undone by expansion or unsustainable practices in others.
2. Given the highly situational nature of any land-based production, including the production of feedstocks for biofuels, it is important that a systems view is taken at a landscape level. If integrated into an overall land-management plan, there are very encouraging opportunities to develop biofuels in such a way as to bring significant benefits at the landscape and catchment level. Analysis and, ultimately, policies based on ecosystem services and natural capital at a landscape level are needed to make the best overall use of land. This would in turn optimise ecosystem services, such as carbon storage, biodiversity, reductions of agricultural run-off and increases in water quality and flood risk management. Complete value chains rather than single bioenergy products should be analysed together to understand the interactions across sectors and land uses with the goal of identifying opportunities where collective benefits can be realised (also referred to as the triple bottom line of economic, environmental and social benefits) <sup>[338]</sup>.
  3. The need to adopt such approaches in relation to land-use planning and management is increasingly recognised in both research and policy communities. DEFRA and its Natural Capital

Committee have been working towards understanding the benefits of land-management based on ecosystem services and natural capital <sup>[377-386]</sup>, developing such approaches and embedding them into policy. This includes developing methods for the valuation of environmental benefits based on economic valuation <sup>[387,388]</sup> as well as non-monetary and participatory methods <sup>[389]</sup>. There have been significant undertakings to assess the state of ecosystems and to characterise ecosystem services both nationally <sup>[380,382]</sup> and in specific areas <sup>[390-392]</sup>. However, while such work provides key concepts and frameworks for thinking about the services that result from the natural environment, there is a need for further research to identify and characterise the ecosystem services that might result specifically from the integration of biofuel crops into the landscape and the considerations that need to be taken into account for the realisation of benefits. Stakeholders consulted during this study identified some potential benefits, such as energy crops helping to manage and reduce nitrate run-off into water bodies or benefits for biodiversity under appropriate plantation and management practices. Some evidence is starting to emerge that substantiates the case for these benefits and how they can be realised<sup>xx</sup>; however, this area requires further research.

4. At the time of writing, a 25-year plan for the environment is under development by DEFRA and the Natural Capital Committee <sup>[394]</sup> and should be an important strategic step toward embedding land-management based on ecosystem services and natural capital. Working across the departments with interests in both land-use planning and biofuels – BEIS, DCLG, DEFRA and the DfT – to ensure that biofuel production is integrated into well-coordinated land-use planning should be an important feature of future policy development.

xx For example, Haughton et al. <sup>[393]</sup> demonstrate that non-food, perennial biomass crops, such as willows and Miscanthus, enhance farmland biodiversity at the landscape level.

# 10.

## Policy recommendations

### Immediate actions

The following priority steps by government are needed in the short term:

- Incentivise the development of second generation biofuels, in the first instance those derived from wastes and agricultural, forest and sawmill residues, followed by dedicated energy crops. The proposed sub-targets for these fuels and the continuation of the double-counting mechanism, both proposed in the 2017 revision of the RTFO, are reasonable steps to take.
- Set a cap for the supply of all crop-based biofuels to reduce the risk of indirect land-use change.
- Where possible, incentivise the use of marginal land (eg. land unsuitable for food production or degraded through deforestation) for the production of biofuels, particularly if soil-carbon stocks can be restored through use.
- Provide and maintain a clear and consistent categorisation of wastes and residues that will avoid unintended market distortions within the UK and internationally.
- Disincentivise high-risk feedstocks that have the potential to drive unsustainable land-use change, primarily deforestation and peat land drainage.
- Increase the level of biofuels required under the RTFO to drive the development of the sector and increase competitiveness of biofuels as well as help towards meeting climate change mitigation targets.

Some of the above recommendations are already being considered by government and we strongly encourage their implementation.

### Next five years

Within the next five years, the following steps by government are needed:

- Work to develop an integrated approach towards land-use planning that integrates and optimises ecosystem services.
- Integrate consideration of biofuels in rural land-use planning and agricultural incentive schemes.
- Continue to play a role in the development and use of consequential LCA (CLCA) to drive methodological improvements, including the models used, data, assumptions and their verification. Consensus building and standardisation of CLCA should be the goal.
- Work towards applying CLCA across the full breadth of land-uses and alternative products with which biofuels are compared, including fossil fuels, to understand better the dynamics of land use by different sectors as well as to ensure a fair treatment of biofuels.
- Until a more comprehensive understanding of land-use systems is available, adopt risk-based approach to biofuels policy. Key components of this should be:
  - further CLCA studies aimed at informing biofuels policies
  - continued regional assessments of biofuels production
  - robust local audit and certification systems
  - inclusion of social and economic impacts.
- Strengthen the assessment by which existing certification schemes are recognised by the European Commission and ensure that robust certification of biofuel supply chains is maintained when the UK leaves the EU.
- Consider other sustainability issues beyond the carbon footprint, including competitiveness of biofuels with fossil fuels, food, energy and water security, employment provision, rural development and human health impacts. The latter is particularly important in view of the current debate on emissions and health impacts from diesel vehicles.
- Consider introducing different incentive bands for second generation biofuels. This would provide differentials in the incentives structure for biofuels that are in earlier stage of development and require a greater incentive than the proven options (eg. first generation fuels).
- Take a more active role in public engagement and debate. Key areas of debate that need to be drawn out include food security, the relationship between investment in agriculture and investment in biofuels, as well as the need to develop biofuels for key transport sectors that lack other low-carbon options (road freight, shipping and aviation).







# References

1. DfT, *Biofuel statistics: Year 8 (2015 to 2016), report 6*. 2017, Department for Transport. [www.gov.uk/government/statistics/biofuel-statistics-year-8-2015-to-2016-report-6](http://www.gov.uk/government/statistics/biofuel-statistics-year-8-2015-to-2016-report-6)
2. Royal Academy of Engineering, *A critical time for UK energy policy: what must be done now to deliver the UK's future energy system. A report for the Council for Science and Technology*. 2015. [www.raeng.org.uk/publications/reports/a-critical-time-for-uk-energy-policy](http://www.raeng.org.uk/publications/reports/a-critical-time-for-uk-energy-policy)
3. HM Government, *Climate Change Act 2008*. 2008, The Stationary Office Limited, chapter 27. [www.opsi.gov.uk/acts/acts2008/pdf/ukpga\\_20080027\\_en.pdf](http://www.opsi.gov.uk/acts/acts2008/pdf/ukpga_20080027_en.pdf): UK
4. European Commission, *Directive (EU) 2015/1513 of the European Parliament and of the Council amending Directive 98/70/EC relating to the quality of petrol and diesel fuels and amending Directive 2009/28/EC on the promotion of the use of energy from renewable sources*. 2015, European Commission: Brussels.
5. European Court of Auditors, *Special Report No. 18: The EU system for the certification of sustainable biofuels*. 2016. [www.eca.europa.eu/Lists/ECADocuments/SR16\\_18/SR\\_BIOFUELS\\_EN.pdf](http://www.eca.europa.eu/Lists/ECADocuments/SR16_18/SR_BIOFUELS_EN.pdf)
6. NNFFC and the Low Carbon Vehicles Partnership (LowCVP), *Pathways to UK Biofuels: A guide to existing and future transport biofuels*. 2010. [www.lowcvp.org.uk/resource-library/reports-and-studies.htm?pg=5](http://www.lowcvp.org.uk/resource-library/reports-and-studies.htm?pg=5)
7. Deutsche Erneuerbare Energieagentur (DENA), *Biomass to Liquid - BTL Implementation Report (Executive Summary)*. 2006: Berlin.
8. International Renewable Energy Agency (IRENA), *Innovation Outlook: Advanced Liquid Biofuels*. 2016, International Renewable Energy Agency: Abu Dhabi.
9. Low Carbon Vehicle Partnership, *Transport Energy Taskforce: Options for transport energy policy to 2030*. 2015. [www.lowcvp.org.uk/projects/transport-energy-task-force.htm](http://www.lowcvp.org.uk/projects/transport-energy-task-force.htm)
10. Michael, K., N. Steffi, and D. Peter, *The Past, Present, and Future of Biofuels - Biobutanol as Promising Alternative*, in *Biofuel Production-Recent Developments and Prospects*, M.A. dos Santos, Editor. 2011, InTech. p. 451-486.
11. Food and Agriculture Organization (FAO), *Biofuels and the sustainability challenge: A global assessment of sustainability issues, trends and policies for biofuels and related feedstocks*. 2013: Rome.
12. Renewable Energy Policy Network for the 21st Century (REN21), *Renewables 2016 - Global Status Report*. 2016. [www.ren21.net/status-of-renewables/global-status-report/](http://www.ren21.net/status-of-renewables/global-status-report/)
13. Boucher, P., *The role of controversy, regulation and engineering in UK biofuel development*. *Energy Policy*, 2012. **42**: p. 148-154.
14. Timilsina, G.R., *Biofuels in the long-run global energy supply mix for transportation*. *Philosophical Transactions of the Royal Society A: Mathematical, Physical and Engineering Sciences*, 2014. **372** (2006).
15. European Commission, *Directive 2009/28/EC of the European Parliament and of the Council of 23 April 2009 on the Promotion of the Use of Energy from Renewable Sources. 2009*, European Commission: Brussels.
16. European Commission, *Eurostat*. 2016. <http://ec.europa.eu/eurostat>.
17. European Commission, *Proposal for a directive of the European Parliament and of the Council on the promotion of the use of energy from renewable sources (recast)*. 2016, European Commission. [http://ec.europa.eu/energy/sites/ener/files/documents/1\\_en\\_act\\_part1\\_v7\\_1.pdf](http://ec.europa.eu/energy/sites/ener/files/documents/1_en_act_part1_v7_1.pdf)
18. DfT, *Explanatory Memorandum to the Renewable Transport Fuel Obligations (Amendment) order 2009*. 2009, Department for Transport.
19. European Commission, *Directive 2003/30/EC of the European Parliament and of the Council of 8 May 2003 on the promotion of the use of biofuels or other renewable fuels for transport*. 2003, European Commission: Brussels.
20. DfT, *RTFO Guidance Part Two: Carbon and Sustainability Guidance RTFO Year 9 15 April 2016 to 14 April 2017*. 2016, Department for Transport.
21. DfT, *Renewable Transport Fuel Obligation statistics: period 8 2015/16, report 6*. 2017, Department for Transport. [www.gov.uk/government/uploads/system/uploads/attachment\\_data/file/588515/rtfo-year-8-report-6.pdf](http://www.gov.uk/government/uploads/system/uploads/attachment_data/file/588515/rtfo-year-8-report-6.pdf)
22. DEFRA, *Crops Grown for Bioenergy in England and the UK: 2015*. 2016. [www.gov.uk/government/uploads/system/uploads/attachment\\_data/file/578845/nonfood-statsnotice2015i-19dec16.pdf](http://www.gov.uk/government/uploads/system/uploads/attachment_data/file/578845/nonfood-statsnotice2015i-19dec16.pdf)
23. NNFFC, *Domestic Energy Crops; Potential and Constraints Review*. 2012. [www.gov.uk/government/uploads/system/uploads/attachment\\_data/file/48342/5138-domestic-energy-crops-potential-and-constraints-r.PDF](http://www.gov.uk/government/uploads/system/uploads/attachment_data/file/48342/5138-domestic-energy-crops-potential-and-constraints-r.PDF)
24. BioGrace, *The BioGrace GHG calculation tool, version 4d*. 2015. [www.biograce.net/home](http://www.biograce.net/home)
25. Malca, J., A. Coelho, and F. Freire, *Environmental life-cycle assessment of rapeseed-based biodiesel: Alternative cultivation systems and locations*. *Applied Energy*, 2014. **114**: p. 837-844.

26. Ecofys, *UK biofuels industry overview -Input to DRAFT PIR* – 2013, Ecofys.  
[www.gov.uk/government/uploads/system/uploads/attachment\\_data/file/266090/ecofys-uk-biofuel-industry-overview-v1.5.pdf](http://www.gov.uk/government/uploads/system/uploads/attachment_data/file/266090/ecofys-uk-biofuel-industry-overview-v1.5.pdf)
27. Committee on Climate Change, *Scope of carbon budgets: Statutory advice on inclusion of international aviation and shipping*. 2012. [www.theccc.org.uk/archive/aws/IA&S/CCC\\_IAS\\_Core\\_ScopeOfBudgets\\_April2012.pdf](http://www.theccc.org.uk/archive/aws/IA&S/CCC_IAS_Core_ScopeOfBudgets_April2012.pdf)
28. Committee on Climate Change, *Building a low-carbon economy - the UK's contribution to tackling climate change*. 2008. <http://archive.theccc.org.uk/archive/pdf/TSO-ClimateChange.pdf>
29. Ricardo, *Technology Roadmap for Low Carbon HGV*. 2010.  
[www.lowcvp.org.uk/initiatives/transportroadmap/VehicleTechnology.htm](http://www.lowcvp.org.uk/initiatives/transportroadmap/VehicleTechnology.htm)
30. AEA, *Assessment of the existing UK infrastructure capacity and vehicle fleet capability for the use of biofuels*. 2011, Final Draft Report to the Department for Transport.
31. ASTM International, *Standard Specification for Diesel Fuel Oil, Biodiesel Blend (B6 to B20)*.  
[www.astm.org/Standards/D7467.htm](http://www.astm.org/Standards/D7467.htm)
32. Jääskeläinen, H., *Biodiesel Standards and Properties. DieselNet Technology Guide*. 2009.  
[www.dieselnet.com/tech/fuel\\_biodiesel\\_std.php](http://www.dieselnet.com/tech/fuel_biodiesel_std.php)
33. Jääskeläinen, H., *Compatibility with Petroleum Diesel Engines. DieselNet Technology Guide*. 2010.  
[www.dieselnet.com/tech/fuel\\_biodiesel\\_comp.php](http://www.dieselnet.com/tech/fuel_biodiesel_comp.php)
34. Jääskeläinen, H., *Low Temperature Operability of Biodiesel. DieselNet Technology Guide*. 2009.  
[www.dieselnet.com/tech/fuel\\_biodiesel\\_lowtemp.php](http://www.dieselnet.com/tech/fuel_biodiesel_lowtemp.php)
35. Smith, H., J. Winfield, and L. Thompson, *The market for biodiesel production from used cooking oils and fats, oils and greases in London*. 2013, LRS Consultancy.  
[www.london.gov.uk/sites/default/files/the\\_market\\_for\\_biodiesel\\_production\\_from\\_ucos\\_and\\_fogs\\_in\\_london\\_-\\_september\\_2013.pdf](http://www.london.gov.uk/sites/default/files/the_market_for_biodiesel_production_from_ucos_and_fogs_in_london_-_september_2013.pdf)
36. IEA, *Technology Roadmap: Biofuels for Transport*. 2011, International Energy Agency: Paris.
37. Searle, S. and C. Malins, *A reassessment of global bioenergy potential in 2050*. GCB Bioenergy, 2015. 7(2): p. 328-336.
38. IEA, *Medium-Term Renewable Energy Market Report 2015*. 2015, OECD/IEA: Paris.
39. Franco, V., F.-P. Sanchez, J. German, and M. P., *Real-World Exhaust Emissions from Modern Diesel Cars*. 2014, The International Council on Clean Transportation.
40. Laybourn-Langton, L., H. Quilter-Pinner, and H. Ho, *Lethal and Illegal: Solving London's Air Pollution Crisis*. 2016, Institute for Public Policy Research.
41. Howard, R., *Up in the air: How to solve London's air quality challenge*. 2015, Policy Exchange.
42. Bosch, *Bosch gasoline direct injection reduced fuel consumption by up to 15 percent, enhances driving enjoyment and is becoming standard worldwide*. 2014.  
[www.bosch-press.de/pressportal/de/en/bosch-gasoline-direct-injection-reduces-fuel-consumption-by-up-to-15-percent-enhances-driving-enjoyment-and-is-becoming-standard-worldwide-42558.html](http://www.bosch-press.de/pressportal/de/en/bosch-gasoline-direct-injection-reduces-fuel-consumption-by-up-to-15-percent-enhances-driving-enjoyment-and-is-becoming-standard-worldwide-42558.html)
43. IEA Energy Technology Systems Analysis Program (IEA-ETSAP), *Ethanol Internal Combustion Engines, Technology Brief T06*. 2010. [https://iea-etsap.org/E-TechDS/PDF/T06\\_Ethanol%20ICES\\_final\\_18Jun10\\_GS\\_OK\\_NH.pdf](https://iea-etsap.org/E-TechDS/PDF/T06_Ethanol%20ICES_final_18Jun10_GS_OK_NH.pdf)
44. Patterson, J., *Preparing for a Life Cycle CO<sub>2</sub> Measure: A report to inform the debate by identifying and establishing the viability of assessing a vehicle's life cycle CO<sub>2</sub>e footprint*. 2011.  
[www.lowcvp.org.uk/resource-library/reports-and-studies.htm?pg=4](http://www.lowcvp.org.uk/resource-library/reports-and-studies.htm?pg=4)
45. Passell, H., H. Dhaliwal, M. Reno, B. Wu, et al., *Algae biodiesel life cycle assessment using current commercial data*. Journal of Environmental Management, 2013. 129: p. 103-111.
46. Hariskos, I. and C. Posten, *Biorefinery of microalgae - opportunities and constraints for different production scenarios*. Biotechnology Journal, 2014. 9(6): p. 739-752.
47. Borowitzka, M.A., *High-value products from microalgae—their development and commercialisation*. Journal of Applied Phycology, 2013. 25(3): p. 743-756.
48. DfT, *Advanced Biofuels Demonstration Competition: grant award*. 2015, DfT.  
[www.gov.uk/government/speeches/advanced-biofuels-demonstration-competition-grant-award](http://www.gov.uk/government/speeches/advanced-biofuels-demonstration-competition-grant-award)
49. Department for Transport, Office for Low Emission Vehicles, and Department for Business, Energy and Industrial Strategy. *Government pledges £290 million boost for low emission vehicles*. 2016.  
[www.gov.uk/government/news/government-pledges-290-million-boost-for-low-emission-vehicles](http://www.gov.uk/government/news/government-pledges-290-million-boost-for-low-emission-vehicles)



50. Department of Energy & Climate Change (DECC), *UK Bioenergy Strategy*. 2012, Department of Energy & Climate Change: London.
51. Ricardo-AEA Ltd, *Biomass Feedstock Availability, Final report for BIES*. 2017. [www.gov.uk/government/uploads/system/uploads/attachment\\_data/file/597387/Biomass\\_feedstock\\_availability\\_final\\_report\\_for\\_publication.pdf](http://www.gov.uk/government/uploads/system/uploads/attachment_data/file/597387/Biomass_feedstock_availability_final_report_for_publication.pdf)
52. Malins, C., S. Searle, A. Baral, D. Turley, et al., *Wasted: Europe's untapped resource: An assessment of advanced biofuels from wastes and residues*. 2014. <https://europeanclimate.org/wp-content/uploads/2014/02/WASTED-final.pdf>
53. Pavlenko, N., S.E. Takriti, C. Malins, and S. Searle, *Beyond the biofrontier: balancing competing uses for the biomass resource*. 2016, International Council on Clean Transportation.
54. Thornley, P., *Biofuels Review*. 2012, Manchester Tyndall Centre for Climate Change Research.
55. NNFFC, *Lignocellulosic feedstock in the UK: A report for the Lignocellulosic Biorefinery Network*. 2014. <http://lb-net.net/wp-content/uploads/2015/04/LBNet-Lignocellulosic-feedstock-in-the-UK.pdf>
56. E4tech, *An assessment of the potential for the establishment of lignocellulosic biorefineries in the UK*. 2016. [www.e4tech.com/wp-content/uploads/2016/10/LBNet-Feasibility-Study\\_Final-Report\\_Updated\\_ES.pdf](http://www.e4tech.com/wp-content/uploads/2016/10/LBNet-Feasibility-Study_Final-Report_Updated_ES.pdf)
57. INEOS, *INEOS Bio Produces Cellulosic Ethanol at Commercial Scale*. 2013. [www.ineos.com/news/ineos-group/ineos-bio-produces-cellulosic-ethanol-at-commercial-scale/](http://www.ineos.com/news/ineos-group/ineos-bio-produces-cellulosic-ethanol-at-commercial-scale/)
58. BEIS, *Energy: Chapter 1, Digest of United Kingdom Energy Statistics (DUKES): Aggregate energy balances*, 2015. [www.gov.uk/government/statistics/energy-chapter-1-digest-of-united-kingdom-energy-statistics-dukes](http://www.gov.uk/government/statistics/energy-chapter-1-digest-of-united-kingdom-energy-statistics-dukes)
59. Azapagic, A. and H. Stichnothe, *Assessing Sustainability of Biofuels, in Sustainable Development in Practice: Case Studies for Engineers and Scientists*, A. Azapagic and S. Perdan, Editors. 2011, John Wiley & Sons: Chichester.
60. Roy, P. and A. Dutta, *Life cycle assessment of ethanol derived from sawdust*. *Bioresource Technology*, 2013. **150**: p. 407-411.
61. Stephenson, A.L., P. Dupree, S.A. Scott, and J.S. Dennis, *The environmental and economic sustainability of potential bioethanol from willow in the UK*. *Bioresource Technology*, 2010. **101**(24): p. 9612-9623.
62. Daystar, J., T. Treasure, R. Gonzalez, C. Reeb, et al., *The NREL Biochemical and Thermochemical Ethanol Conversion Processes: Financial and Environmental Analysis Comparison*. *Bioresources*, 2015. **10**(3): p. 5096-5116.
63. Sanchez, S.T., J. Woods, M. Akhurst, M. Brander, et al., *Accounting for indirect land-use change in the life cycle assessment of biofuel supply chains*. *Journal of the Royal Society Interface*, 2012. **9**(71): p. 1105-1119.
64. Plevin, R.J., M.A. Delucchi, and F. Creutzig, *Using Attributional Life Cycle Assessment to Estimate Climate-Change Mitigation Benefits Misleads Policy Makers*. *Journal of Industrial Ecology*, 2014. **18**(1): p. 73-83.
65. EPA, *Renewable Fuel Standard Program (RFS2) Regulatory Impact Analysis (EPA-420-R-10-006)*. 2010, U.S. Environmental Protection Agency, Office of Transportation and Air Quality, Assessment and Standards Division: [www.epa.gov/otaq/fuels/renewablefuels/regulations.htm](http://www.epa.gov/otaq/fuels/renewablefuels/regulations.htm)
66. Kim, S., B.E. Dale, R. Heijungs, A. Azapagic, et al., *Indirect land use change and biofuels: Mathematical analysis reveals a fundamental flaw in the regulatory approach*. *Biomass and Bioenergy*, 2014. **71**: p. 408-412.
67. McManus, M.C., C.M. Taylor, A. Mohr, C. Whittaker, et al., *Challenge clusters facing LCA in environmental decision-making—what we can learn from biofuels*. *The International Journal of Life Cycle Assessment*, 2015. **20**(10): p. 1399-1414.
68. Zamagni, A., J. Guinée, R. Heijungs, P. Masoni, et al., *Lights and shadows in consequential LCA*. *The International Journal of Life Cycle Assessment*, 2012. **17**(7): p. 904-918.
69. Brander, M., R. Tipper, C. Hutchison, and G. Davis, *Consequential and Attributional Approaches to LCA: a Guide to Policy Makers with Specific Reference to Greenhouse Gas LCA of Biofuels*. 2009, Ecometrica.
70. Searchinger, T., R. Heimlich, R.A. Houghton, F. Dong, et al., *Use of U.S. Croplands for Biofuels Increases Greenhouse Gases Through Emissions from Land-Use Change*. *Science*, 2008. **319**(5867): p. 1238-1240.
71. ISO, *ISO 14040:2006 Environmental management – Life cycle assessment – Principles and framework*. 2006, BSI: London.
72. ISO, *ISO14044:2006 Environmental management – Life cycle assessment – Requirements and guidelines*. 2006, BSI: London.
73. BSI, *Publicly Available Specification 2050:2011—Specification for the Assessment of the Life Cycle Greenhouse Gas Emissions of Goods and Services*. 2011, British Standards Institute: London.

74. World Resource Institute and World Business Council for Sustainable Development, *Product Life Cycle Accounting and Reporting Standard - Greenhouse Gas Protocol*. 2011, World Resource Institute and World Business Council for Sustainable Development: US.
75. ISO, *ISO 14067 - Greenhouse Gases - Carbon Footprint of Products - Requirements and Guidelines for Quantification and Communication*. 2013, International Organization for Standardization: Geneva.
76. ISO, *ISO 13065:2015- Sustainability criteria for bioenergy*. 2015, International Organization for Standardization: Geneva.
77. German, L. and G. Schoneveld, *A review of social sustainability considerations among EU-approved voluntary schemes for biofuels, with implications for rural livelihoods*. *Energy Policy*, 2012. **51**: p. 765-778.
78. IUCN, National Committee of the Netherlands, *Betting on best quality: A comparison of the quality and level of assurance of sustainability standards for biomass, soy and palm oil*. 2013. [https://cmsdata.iucn.org/downloads/betting\\_on\\_best\\_quality.pdf](https://cmsdata.iucn.org/downloads/betting_on_best_quality.pdf)
79. WWF, *Searching for Sustainability: Comparative Analysis of Certification Schemes for Biomass used for the Production of Biofuels*. 2013. [http://awsassets.panda.org/downloads/wwf\\_searching\\_for\\_sustainability\\_2013\\_2.pdf](http://awsassets.panda.org/downloads/wwf_searching_for_sustainability_2013_2.pdf)
80. DECC, *Renewables Obligation Order 2009 as amended by the Renewables Obligation (Amendment) Order 2014*. 2014, Department of Energy & Climate Change. [www.gov.uk/government/publications/renewables-obligation-order-2009-as-amended-by-the-renewables-obligation-amendment-order-2014-2](http://www.gov.uk/government/publications/renewables-obligation-order-2009-as-amended-by-the-renewables-obligation-amendment-order-2014-2)
81. Forest Europe, *Sustainable Forest Management (SFM) Criteria & Indicators*. 2016. <http://foresteurope.org/sfm-criteria-indicators2/>
82. European Commission, *Commission Notice of 12.2.2016 Guidance Document for the EU Timber Regulation*. 2016, European Commission. [http://ec.europa.eu/environment/forests/timber\\_regulation.htm](http://ec.europa.eu/environment/forests/timber_regulation.htm)
83. PEFC, *Promoting Sustainable Forest Management*. 2016, Programme for the Endorsement of Forest Certification. [www.pefc.co.uk/](http://www.pefc.co.uk/)
84. FSC, *The Forest Stewardship Council (FSC)* 2016. [www.fsc-uk.org/en-uk/about-fsc](http://www.fsc-uk.org/en-uk/about-fsc)
85. The Sustainable Biomass Partnership (SBP), *SBP Framework Standard 1: Feedstock Compliance Standard*. 2015, The Sustainable Biomass Partnership Limited. [www.sustainablebiomasspartnership.org/docs/2015-03/sbp-standard-1-feedstock-compliance-standard-v1-0.pdf](http://www.sustainablebiomasspartnership.org/docs/2015-03/sbp-standard-1-feedstock-compliance-standard-v1-0.pdf)
86. ISEAL, [www.isealalliance.org/about-us](http://www.isealalliance.org/about-us)
87. ISEAL, *ISEAL members*. [www.isealalliance.org/our-members](http://www.isealalliance.org/our-members)
88. NRDC, *Biofuel Sustainability Performance Guidelines*. 2014, Natural Resources Defense Council. [www.nrdc.org/sites/default/files/biofuels-sustainability-certification-report.pdf](http://www.nrdc.org/sites/default/files/biofuels-sustainability-certification-report.pdf)
89. McManus, M.C. and C.M. Taylor, *The changing nature of life cycle assessment*. *Biomass and Bioenergy*, 2015. **82**: p. 13-26.
90. Singh, A., D. Pant, N.E. Korres, A.-S. Nizami, et al., *Key issues in life cycle assessment of ethanol production from lignocellulosic biomass: Challenges and perspectives*. *Bioresource Technology*, 2010. **101**(13): p. 5003-5012.
91. Wiloso, E.I., R. Heijungs, and G.R. de Snoo, *LCA of second generation bioethanol: A review and some issues to be resolved for good LCA practice*. *Renewable & Sustainable Energy Reviews*, 2012. **16**(7): p. 5295-5308.
92. Prasara-A, J. and T. Grant, *Comparative life cycle assessment of uses of rice husk for energy purposes*. *International Journal of Life Cycle Assessment*, 2011. **16**(6): p. 493-502.
93. Moghaddam, E.A., S. Ahlgren, C. Hultberg, and A. Nordberg, *Energy balance and global warming potential of biogas-based fuels from a life cycle perspective*. *Fuel Processing Technology*, 2015. **132**: p. 74-82.
94. Garba, N.A., L.J. Duckers, and W.J. Hall, *Climate change impacts on life cycle greenhouse gas (GHG) emissions savings of biomethanol from corn and soybean*. *International Journal of Life Cycle Assessment*, 2014. **19**(4): p. 806-813.
95. Lim, S. and K.T. Lee, *Parallel production of biodiesel and bioethanol in palm-oil-based biorefineries: life cycle assessment on the energy and greenhouse gases emissions*. *Biofuels Bioproducts & Biorefining-Biofpr*, 2011. **5**(2): p. 132-150.
96. Cherubini, F. and G. Jungmeier, *LCA of a biorefinery concept producing bioethanol, bioenergy, and chemicals from switchgrass*. *The International Journal of Life Cycle Assessment*, 2010. **15**(1): p. 53-66.

97. Jeswani, H.K., T. Falano, and A. Azapagic, *Life cycle environmental sustainability of lignocellulosic ethanol produced in integrated thermo-chemical biorefineries*. *Biofuels Bioproducts & Biorefining-Biofpr*, 2015. **9**(6): p. 661-676.
98. Yan, X. and A.M. Boies, *Quantifying the uncertainties in life cycle greenhouse gas emissions for UK wheat ethanol*. *Environmental Research Letters*, 2013. **8**(1).
99. Kim, S. and B.E. Dale, *Regional variations in greenhouse gas emissions of biobased products in the United States—corn-based ethanol and soybean oil*. *The International Journal of Life Cycle Assessment*, 2009. **14**(6): p. 540-546.
100. Luo, L., E. van der Voet, G. Huppes, and H.A. Udo de Haes, *Allocation issues in LCA methodology: a case study of corn stover-based fuel ethanol*. *The International Journal of Life Cycle Assessment*, 2009. **14**(6): p. 529-539.
101. IPCC, *Climate Change 2013: The Physical Science Basis. Contribution of Working Group I to the Fifth Assessment Report of the Intergovernmental Panel on Climate Change*. 2013, Intergovernmental Panel on Climate Change: Cambridge.
102. Harris, Z.M., R. Spake, and G. Taylor, *Land use change to bioenergy: A meta-analysis of soil carbon and GHG emissions*. *Biomass & Bioenergy*, 2015. **82**: p. 27-39.
103. Fargione, J., J. Hill, D. Tilman, S. Polasky, et al., *Land Clearing and the Biofuel Carbon Debt*. *Science*, 2008. **319**(5867): p. 1235-1238.
104. Mello, F.F.C., C.E.P. Cerri, C.A. Davies, N.M. Holbrook, et al., *Payback time for soil carbon and sugar-cane ethanol*. *Nature Clim. Change*, 2014. **4**(7): p. 605-609.
105. Lamers, P. and M. Junginger, *The 'debt' is in the detail: A synthesis of recent temporal forest carbon analyses on woody biomass for energy*. *Biofuels, Bioproducts and Biorefining*, 2013. **7**(4): p. 373-385.
106. Borjesson, P. and L.M. Tufvesson, *Agricultural crop-based biofuels - resource efficiency and environmental performance including direct land use changes*. *Journal of Cleaner Production*, 2011. **19**(2-3): p. 108-120.
107. Pawelzik, P., M. Carus, J. Hotchkiss, R. Narayan, et al., *Critical aspects in the life cycle assessment (LCA) of bio-based materials - Reviewing methodologies and deriving recommendations*. *Resources Conservation and Recycling*, 2013. **73**: p. 211-228.
108. Farrell, A.E., R.J. Plevin, B.T. Turner, A.D. Jones, et al., *Ethanol Can Contribute to Energy and Environmental Goals*. *Science*, 2006. **311**(5760): p. 506-508.
109. Renewable Fuels Agency, *The Gallagher Review of the indirect effects of biofuels production*. 2008. <http://webarchive.nationalarchives.gov.uk/20110407094507/renewablefuelsagency.gov.uk/reportsandpublications/reviewoftheindirecteffectsofbiofuels>
110. Humpenoeder, F., R. Schaldach, Y. Cikovani, and L. Schebek, *Effects of land-use change on the carbon balance of 1st generation biofuels: An analysis for the European Union combining spatial modeling and LCA*. *Biomass & Bioenergy*, 2013. **56**: p. 166-178.
111. Tonini, D., L. Hamelin, M. Alvarado-Morales, and T.F. Astrup, *GHG emission factors for bioelectricity, biomethane, and bioethanol quantified for 24 biomass substrates with consequential life-cycle assessment*. *Bioresource Technology*, 2016. **208**: p. 123-133.
112. IPCC, *Revised 1996 IPCC Guidelines for national greenhouse gas inventories: workbook-module 24 agriculture*. J. Houghton and e. al., Editors. 1996.
113. European Commission, *Commission decision of 10 June 2010 on guidelines for the calculation of land carbon stocks for the purpose of Annex V to Directive 2009/28/EC*. 2010. [www.ebb-eu.org/sustain/EC%20Decision%20land%20carbon%20stocks%20June%202010.pdf](http://www.ebb-eu.org/sustain/EC%20Decision%20land%20carbon%20stocks%20June%202010.pdf)
114. Plevin, R.J., M. O'Hare, A.D. Jones, M.S. Torn, et al., *Greenhouse Gas Emissions from Biofuels' Indirect Land Use Change Are Uncertain but May Be Much Greater than Previously Estimated*. *Environmental Science & Technology*, 2010. **44**(21): p. 8015-8021.
115. Yang, Y. and S. Suh, *Marginal yield, technological advances, and emissions timing in corn ethanol's carbon payback time*. *International Journal of Life Cycle Assessment*, 2015. **20**(2): p. 226-232.
116. Ahlgren, S. and L. Di Lucia, *Indirect land use changes of biofuel production - a review of modelling efforts and policy developments in the European Union*. *Biotechnology for Biofuels*, 2014. **7**(1): p. 35.
117. Laborde, D., *Assessing the Land Use Change Consequences of European Biofuel Policies', Final report*. 2011, International Food Policy Research Institute, ATLISS Consortium. [http://trade.ec.europa.eu/doclib/docs/2011/october/tradoc\\_148289.pdf](http://trade.ec.europa.eu/doclib/docs/2011/october/tradoc_148289.pdf)
118. Ecofys, *The land use change impact of biofuels consumed in the EU Quantification of area and greenhouse gas impacts*. 2015, Ecofys, IIASA and E4tech.



119. Lywood, W., *Issues of concern with models for calculating GHG emissions from indirect land use change, revision 1*. 2010, Ensus: Yarm, UK.
120. Agricultural Industries Confederation (AIC), National Farmers Union (NFU), Renewable Energy Association (REA), and the Seed Crushers and Oil Processors Association (SCOPA), *The effects on the UK biofuel industry of the EU proposals on Indirect Land Use Change (COM 2012) 595 final of 17 October 2012, and UK Biofuels Industry counter-proposals*. 2013. [www.r-e-a.net/resources/pdf/104/FINALREANFUSCOPAAICIndustry\\_positionILUC18Feb13.pdf](http://www.r-e-a.net/resources/pdf/104/FINALREANFUSCOPAAICIndustry_positionILUC18Feb13.pdf)
121. Linares, P. and I.J. Pérez-Arriaga, *A sustainable framework for biofuels in Europe*. *Energy Policy*, 2013. **52**: p. 166-169.
122. International Council on Clean Transportation (ICCT), *Comprehensive carbon accounting for identification of sustainable biomass feedstocks*. 2014, International Council on Clean Transportation: Washington.
123. Berndes, G., B. Abt, A. Asikainen, A. Cowie, et al., *Forest biomass, carbon neutrality and climate change mitigation*. 2016. [www.efi.int/files/attachments/publications/efi\\_fstp\\_3\\_2016.pdf](http://www.efi.int/files/attachments/publications/efi_fstp_3_2016.pdf)
124. Levasseur, A., M. Brandao, P. Lesage, M. Margni, et al., *Valuing temporary carbon storage*. *Nature Clim. Change*, 2012. **2**(1): p. 6-8.
125. Cherubini, F., G.P. Peters, T. Berntsen, A.H. Strømman, et al., *CO<sub>2</sub> emissions from biomass combustion for bioenergy: Atmospheric decay and contribution to global warming*. *GCB Bioenergy*, 2011. **3**: p. 413-426.
126. Matthews, R., L. Sokka, S. Soimakallio, N. Mortimer, et al., *Review of literature on biogenic carbon and life cycle assessment of forest bioenergy*. 2014, Forest Research. [https://ec.europa.eu/energy/sites/ener/files/2014\\_biomass\\_forest\\_research\\_report\\_.pdf](https://ec.europa.eu/energy/sites/ener/files/2014_biomass_forest_research_report_.pdf)
127. European Forest Institute, *The European Forest Information SCENario Model (EFISCEN)*. [www.efi.int/portal/virtual\\_library/databases/efiscen/](http://www.efi.int/portal/virtual_library/databases/efiscen/)
128. International Institute for Applied Systems Analysis, *The Global Forest Model (G4M)*. [www.iiasa.ac.at/web/home/research/modelsData/G4M.en.html](http://www.iiasa.ac.at/web/home/research/modelsData/G4M.en.html)
129. Forest Research, *The CARBINE carbon accounting model*. [www.forestry.gov.uk/fr/infd-633dxb](http://www.forestry.gov.uk/fr/infd-633dxb)
130. Kull, S.J., G.J. Rampley, S. Morken, J. Metsaranta, et al., *Operational-scale carbon budget model of the Canadian forest sector (CBM-CFS3)*. 2016: <http://cfs.nrcan.gc.ca/publications?id=36556>
131. Brack, D., *Biomass for Power and Heat: Impacts on the Global Climate*. 2017. [www.chathamhouse.org/publication/woody-biomass-power-and-heat-impacts-global-climate](http://www.chathamhouse.org/publication/woody-biomass-power-and-heat-impacts-global-climate)
132. IEA Bioenergy, *IEA Bioenergy Response to Chatham House report "Woody Biomass for Power and Heat: Impacts on the Global Climate"*. 2017: [www.ieabioenergy.com/publications/iea-bioenergy-response/](http://www.ieabioenergy.com/publications/iea-bioenergy-response/)
133. Strange Olesen, A., S.L. Bager, B. Kittler, W. Price, et al., *Environmental implications of increased reliance of the EU on biomass from the South East US*. 2015. [www.aebiom.org/wp.../DG-ENVI-study-imports-from-US-Final-report-July-2016.pdf](http://www.aebiom.org/wp.../DG-ENVI-study-imports-from-US-Final-report-July-2016.pdf)
134. Qin, Z., J.B. Dunn, H. Kwon, S. Mueller, et al., *Soil carbon sequestration and land use change associated with biofuel production: empirical evidence*. *Global Change Biology Bioenergy*, 2016. **8**(1): p. 66-80.
135. Smith, P., *Soils and climate change*. *Current Opinion in Environmental Sustainability*, 2012. **4**(5): p. 539-544.
136. Cherubini, F. and S. Ulgiati, *Crop residues as raw materials for biorefinery systems - A LCA case study*. *Applied Energy*, 2010. **87**(1): p. 47-57.
137. Koponen, K., S. Soimakallio, E. Tsupari, R. Thun, et al., *GHG emission performance of various liquid transportation biofuels in Finland in accordance with the EU sustainability criteria*. *Applied Energy*, 2013. **102**: p. 440-448.
138. Qin, Z., J.B. Dunn, H. Kwon, S. Mueller, et al., *Influence of spatially dependent, modeled soil carbon emission factors on life-cycle greenhouse gas emissions of corn and cellulosic ethanol*. *GCB Bioenergy*, 2016. **8**(6): p. 1136-1149.
139. Schmer, M.R., V.L. Jin, and B.J. Wienhold, *Sub-surface soil carbon changes affects biofuel greenhouse gas emissions*. *Biomass & Bioenergy*, 2015. **81**: p. 31-34.
140. Goglio, P., W.N. Smith, B.B. Grant, R.L. Desjardins, et al., *Accounting for soil carbon changes in agricultural life cycle assessment (LCA): a review*. *Journal of Cleaner Production*, 2015. **104**: p. 23-39.
141. Rowe, R.L., A.M. Keith, D. Elias, M. Dondini, et al., *Initial soil C and land-use history determine soil C sequestration under perennial bioenergy crops*. *GCB Bioenergy*, 2016. **8**(6): p. 1046-1060.
142. Richards, M., M. Pogson, M. Dondini, E.O. Jones, et al., *High-resolution spatial modelling of greenhouse gas emissions from land-use change to energy crops in the United Kingdom*. *GCB Bioenergy*, 2017. **9**(3): p. 627-644.

143. Brandão, M., L. Milà i Canals, and R. Clift, *Soil organic carbon changes in the cultivation of energy crops: Implications for GHG balances and soil quality for use in LCA*. Biomass and Bioenergy, 2011. **35**(6): p. 2323–2336.
144. Pourhashem, G., P.R. Adler, and S. Spatari, *Time effects of climate change mitigation strategies for second generation biofuels and co-products with temporary carbon storage*. Journal of Cleaner Production, 2016. **112**: p. 2642–2653.
145. Liska, A.J., H. Yang, M. Milner, S. Goddard, et al., *Biofuels from crop residue can reduce soil carbon and increase CO<sub>2</sub> emissions*. Nature Clim. Change, 2014. **4**(5): p. 398–401.
146. Whittaker, C., A.L. Borrion, L. Newnes, and M. McManus, *The renewable energy directive and cereal residues*. Applied Energy, 2014. **122**: p. 207–215.
147. Blanco-Canqui, H., *Crop Residue Removal for Bioenergy Reduces Soil Carbon Pools: How Can We Offset Carbon Losses?* Bioenergy Research, 2013. **6**(1): p. 358–371.
148. Cherubini, F. and A.H. Stromman, *Life cycle assessment of bioenergy systems: State of the art and future challenges*. Bioresource Technology, 2011. **102**(2): p. 437–451.
149. Menten, F., B. Cheze, L. Patouillard, and F. Bouvart, *A review of LCA greenhouse gas emissions results for advanced biofuels: The use of meta-regression analysis*. Renewable & Sustainable Energy Reviews, 2013. **26**: p. 108–134.
150. Crutzen, P.J., A.R. Mosier, K.A. Smith, and W. Winiwarter, *N<sub>2</sub>O release from agro-biofuel production negates global warming reduction by replacing fossil fuels*. Atmos. Chem. Phys., 2008. **8**: p. 289–395.
151. Liska, A.J., *Eight Principles of Uncertainty for Life Cycle Assessment of Biofuel Systems*. Adam Liska Papers, 2015. **26**.
152. Sylvester-Bradley, R., R. Thorman, D. Kindred, S. Wynn, et al., *Minimising nitrous oxide intensities of arable crop products (MIN-NO), 2015*. AHDB. <https://cereals.ahdb.org.uk/media/759084/pr548.pdf>
153. Whitaker, J., K.E. Ludley, R. Rowe, G. Taylor, et al., *Sources of variability in greenhouse gas and energy balances for biofuel production: a systematic review*. GCB Bioenergy, 2010. **2**(3): p. 99–112.
154. Moller, F., E. Slento, and P. Frederiksen, *Integrated well-to-wheel assessment of biofuels combining energy and emission LCA and welfare economic Cost Benefit Analysis*. Biomass & Bioenergy, 2014. **60**: p. 41–49.
155. Pfister, S. and L. Scherer, *Uncertainty analysis of the environmental sustainability of biofuels*. Energy Sustainability and Society, 2015. **5**(1).
156. Gallejones, P., G. Pardo, A. Aizpurua, and A. del Prado, *Life cycle assessment of first-generation biofuels using a nitrogen crop model*. Science of the Total Environment, 2015. **505**: p. 1191–1201.
157. Cai, H. and M.Q. Wang, *Consideration of Black Carbon and Primary Organic Carbon Emissions in Life-Cycle Analysis of Greenhouse Gas Emissions of Vehicle Systems and Fuels*. Environmental Science & Technology, 2014. **48**(20): p. 12445–12453.
158. Hennecke, A.M., M. Faist, J. Reinhardt, V. Junquera, et al., *Biofuel greenhouse gas calculations under the European Renewable Energy Directive - A comparison of the BioGrace tool vs. the tool of the Roundtable on Sustainable Biofuels*. Applied Energy, 2013. **102**: p. 55–62.
159. Sills, D.L., V. Paramita, M.J. Franke, M.C. Johnson, et al., *Quantitative Uncertainty Analysis of Life Cycle Assessment for Algal Biofuel Production*. Environmental Science & Technology, 2013. **47**(2): p. 687–694.
160. Agrawal, A., A. Chhatre, and R. Hardin, *Changing Governance of the World's Forests*. Science, 2008. **320**(5882): p. 1460–1462.
161. FAO, *Global Forest Resources Assessment: Main report: Forestry Paper 163*. 2010, Food and Agriculture Organization. [www.fao.org/docrep/013/i1757e/i1757e.pdf](http://www.fao.org/docrep/013/i1757e/i1757e.pdf)
162. Kline, K.L., V.H. Dale, R. Lee, and P.N. Leiby, *In Defense of Biofuels, Done Right*. Issues in Science & Technology, 2009: p. 75–84.
163. Barbier, E.B., *The economic determinants of land degradation in developing countries*. Philosophical Transactions of the Royal Society B: Biological Sciences, 1997. **352**(1356): p. 891–899.
164. Kline, K.L., G.A. Oladosu, V.H. Dale, and A.C. McBride, *Scientific analysis is essential to assess biofuel policy effects: In response to the paper by Kim and Dale on "Indirect land-use change for biofuels: Testing predictions and improving analytical methodologies"*. Biomass and Bioenergy, 2011. **35**(10): p. 4488–4491.
165. Kline, K.L. and V.H. Dale, *Biofuels, causes of land-use change, and the role of fire in greenhouse gas emissions*. Science, 2008: p. Medium: X; Size: 199–201.
166. Giglio, L., J.T. Randerson, G.R. van der Werf, P.S. Kasibhatla, et al., *Assessing variability and long-term trends in burned area by merging multiple satellite fire products*. Biogeosciences, 2010. **7**(3): p. 1171–1186.

167. Darlington, T. and D. Kahlbaum, *Land Use Change Greenhouse Gas Emissions of European Biofuel Policies Utilizing the GTAP Model*. 2013.  
www.ebb-eu.org/studiesreports/GTAP%20Report%20ILUC%20Aug%2030%202013%20Final.pdf
168. The Agricultural Model Intercomparison and Improvement Project, *About*. 2014. www.agmip.org/about/
169. The Agricultural Model Intercomparison and Improvement Project, *Bioenergy-Crop Model Initiative*. 2014.  
www.agmip.org/research/research-initiatives/bioenergy-crop-model-initiative/
170. E4Tech, *A causal descriptive approach to modelling the GHG emissions associated with the indirect land use impacts of biofuels*. 2010.  
www.e4tech.com/wp-content/uploads/2015/06/Modelling\_ILUC\_of\_biofuel\_2010.pdf
171. Zhang, Y. and A. Kendall, *Life Cycle Performance of Cellulosic Ethanol and Corn Ethanol from a Retrofitted Dry Mill Corn Ethanol Plant*. Bioenergy Research, 2016: p. 1-16.
172. Styles, D., J. Gibbons, A.P. Williams, J. Dauber, et al., *Consequential life cycle assessment of biogas, biofuel and biomass energy options within an arable crop rotation*. Global Change Biology Bioenergy, 2015. **7**(6): p. 1305-1320.
173. Lisboa, C.C., K. Butterbach-Bahl, M. Mauder, and R. Kiese, *Bioethanol production from sugarcane and emissions of greenhouse gases - known and unknowns*. Global Change Biology Bioenergy, 2011. **3**(4): p. 277-292.
174. García, C.A., A. Fuentes, A. Hennecke, E. Riegelhaupt, et al., *Life-cycle greenhouse gas emissions and energy balances of sugarcane ethanol production in Mexico*. Applied Energy, 2011. **88**(6): p. 2088-2097.
175. Panichelli, L., A. Dauriat, and E. Gnansounou, *Life cycle assessment of soybean-based biodiesel in Argentina for export*. International Journal of Life Cycle Assessment, 2009. **14**(2): p. 144-159.
176. Esteves, V.P.P., E.M.M. Esteves, D.J. Bungenstab, D.G.d.S.W. Loebmann, et al., *Land use change (LUC) analysis and life cycle assessment (LCA) of Brazilian soybean biodiesel*. Clean Technologies and Environmental Policy, 2016. **18**(6): p. 1655-1673.
177. Hassan, M.N.A., P. Jaramillo, and W.M. Griffin, *Life cycle GHG emissions from Malaysian oil palm bioenergy development: The impact on transportation sector's energy security*. Energy Policy, 2011. **39**(5): p. 2615-2625.
178. Muñoz, I., K. Flury, N. Jungbluth, G. Rigarlford, et al., *Life cycle assessment of bio-based ethanol produced from different agricultural feedstocks*. The International Journal of Life Cycle Assessment, 2014. **19**(1): p. 109-119.
179. Walter, A., P. Dolzan, O. Quilodrán, J.G. de Oliveira, et al., *Sustainability assessment of bio-ethanol production in Brazil considering land use change, GHG emissions and socio-economic aspects*. Energy Policy, 2011. **39**(10): p. 5703-5716.
180. Dunn, J.B., S. Mueller, H.-y. Kwon, and M.Q. Wang, *Land-use change and greenhouse gas emissions from corn and cellulosic ethanol*. Biotechnology for Biofuels, 2013. **6**(1): p. 51.
181. Wang, M., J. Han, J.B. Dunn, H. Cai, et al., *Well-to-wheels energy use and greenhouse gas emissions of ethanol from corn, sugarcane and cellulosic biomass for US use*. Environ Res Lett, 2012. **7**.
182. Michael, W., H. Jeongwoo, B.D. Jennifer, C. Hao, et al., *Well-to-wheels energy use and greenhouse gas emissions of ethanol from corn, sugarcane and cellulosic biomass for US use*. Environmental Research Letters, 2012. **7**(4): p. 045905.
183. Canter, C.E., J.B. Dunn, J. Han, Z. Wang, et al., *Policy Implications of Allocation Methods in the Life Cycle Analysis of Integrated Corn and Corn Stover Ethanol Production*. Bioenergy Research, 2016. **9**(1): p. 77-87.
184. Ou, X., X. Zhang, S. Chang, and Q. Guo, *Energy consumption and GHG emissions of six biofuel pathways by LCA in (the) People's Republic of China*. Applied Energy, 2009. **86**: p. S197-S208.
185. Liska, A.J., H.S. Yang, V.R. Bremer, T.J. Klopfenstein, et al., *Improvements in Life Cycle Energy Efficiency and Greenhouse Gas Emissions of Corn-Ethanol*. Journal of Industrial Ecology, 2009. **13**(1): p. 58-74.
186. Kauffman, N., D. Hayes, and R. Brown, *A life cycle assessment of advanced biofuel production from a hectare of corn*. Fuel, 2011. **90**(11): p. 3306-3314.
187. Belboom, S., B. Bodson, and A. Léonard, *Does the production of Belgian bioethanol fit with European requirements on GHG emissions? Case of wheat*. Biomass and Bioenergy, 2015. **74**: p. 58-65.
188. Martinez-Hernandez, E., M.H. Ibrahim, M. Leach, P. Sinclair, et al., *Environmental sustainability analysis of UK whole-wheat bioethanol and CHP systems*. Biomass and Bioenergy, 2013. **50**: p. 52-64.
189. Buchspies, B. and M. Kaltschmitt, *Life cycle assessment of bioethanol from wheat and sugar beet discussing environmental impacts of multiple concepts of co-product processing in the context of the European Renewable Energy Directive*. Biofuels, 2016. **7**(2): p. 141-153.



190. Elsgaard, L., J.E. Olesen, J.E. Hermansen, I.T. Kristensen, et al., *Regional greenhouse gas emissions from cultivation of winter wheat and winter rapeseed for biofuels in Denmark*. Acta Agriculturae Scandinavica Section B-Soil and Plant Science, 2013. **63**(3): p. 219–230.
191. Weinberg, J. and M. Kaltschmitt, *Greenhouse gas emissions from first generation ethanol derived from wheat and sugar beet in Germany – Analysis and comparison of advanced by-product utilization pathways*. Applied Energy, 2013. **102**: p. 131–139.
192. Wang, L., R. Quiceno, C. Price, R. Malpas, et al., *Economic and GHG emissions analyses for sugarcane ethanol in Brazil: Looking forward*. Renewable and Sustainable Energy Reviews, 2014. **40**: p. 571–582.
193. Souza, S.P. and J.E.A. Seabra, *Integrated production of sugarcane ethanol and soybean biodiesel: Environmental and economic implications of fossil diesel displacement*. Energy Conversion and Management, 2014. **87**: p. 1170–1179.
194. Souza, S.P., A.R. Gopal, and J.E.A. Seabra, *Life cycle assessment of biofuels from an integrated Brazilian algae-sugarcane biorefinery*. Energy, 2015. **81**: p. 373–381.
195. Tsiropoulos, I., A.P.C. Faaij, J.E.A. Seabra, L. Lundquist, et al., *Life cycle assessment of sugarcane ethanol production in India in comparison to Brazil*. International Journal of Life Cycle Assessment, 2014. **19**(5): p. 1049–1067.
196. Cavalett, O., M.F. Chagas, J.E.A. Seabra, and A. Bonomi, *Comparative LCA of ethanol versus gasoline in Brazil using different LCA methods*. The International Journal of Life Cycle Assessment, 2013. **18**(3): p. 647–658.
197. Tomaschek, J., E.D. Oezdemir, U. Fahl, and L. Eltrop, *Greenhouse gas emissions and abatement costs of biofuel production in South Africa*. Global Change Biology Bioenergy, 2012. **4**(6): p. 799–810.
198. Mandade, P., B.R. Bakshi, and G.D. Yadav, *Ethanol from Indian agro-industrial lignocellulosic biomass—a life cycle evaluation of energy, greenhouse gases, land and water*. The International Journal of Life Cycle Assessment, 2015. **20**(12): p. 1649–1658.
199. Seabra, J.E.A., I.C. Macedo, H.L. Chum, C.E. Faroni, et al., *Life cycle assessment of Brazilian sugarcane products: GHG emissions and energy use*. Biofuels, Bioproducts and Biorefining, 2011. **5**(5): p. 519–532.
200. Bessou, C., S. Lehuger, B. Gabrielle, and B. Mary, *Using a crop model to account for the effects of local factors on the LCA of sugar beet ethanol in Picardy region, France*. International Journal of Life Cycle Assessment, 2013. **18**(1): p. 24–36.
201. Halleux, H., S. Lassaux, R. Renzoni, and A. Germain, *Comparative life cycle assessment of two biofuels ethanol from sugar beet and rapeseed methyl ester*. International Journal of Life Cycle Assessment, 2008. **13**(3): p. 184–190.
202. European Commission, *Council Directive (EU) 2015/652 of 20 April 2015 laying down calculation methods and reporting requirements pursuant to Directive 98/70/EC of the European Parliament and of the Council relating to the quality of petrol and diesel fuels*. 2015, European Commission: Brussels.
203. Arvidsson, R., S. Persson, M. Froling, and M. Svanstrom, *Life cycle assessment of hydrotreated vegetable oil from rape, oil palm and Jatropha*. Journal of Cleaner Production, 2011. **19**(2–3): p. 129–137.
204. Arpornpong, N., D.A. Sabatini, S. Khaodhiar, and A. Charoensaeng, *Life cycle assessment of palm oil microemulsion-based biofuel*. International Journal of Life Cycle Assessment, 2015. **20**(7): p. 913–926.
205. Pleanjai, S. and S.H. Gheewala, *Full chain energy analysis of biodiesel production from palm oil in Thailand*. Applied Energy, 2009. **86**, Supplement 1: p. S209–S214.
206. Reijnders, L. and M.A.J. Huijbregts, *Biogenic greenhouse gas emissions linked to the life cycles of biodiesel derived from European rapeseed and Brazilian soybeans*. Journal of Cleaner Production, 2008. **16**(18): p. 1943–1948.
207. Castanheira, É.G. and F. Freire, *Environmental life cycle assessment of biodiesel produced with palm oil from Colombia*. The International Journal of Life Cycle Assessment, 2016: p. 1–14.
208. Reinhard, J. and R. Zah, *Global environmental consequences of increased biodiesel consumption in Switzerland: consequential life cycle assessment*. Journal of Cleaner Production, 2009. **17**, Supplement 1: p. S46–S56.
209. Intarapong, P., S. Papong, and P. Malakul, *Comparative life cycle assessment of diesel production from crude palm oil and waste cooking oil via pyrolysis*. International Journal of Energy Research, 2016. **40**(5): p. 702–713.
210. Abdul-Manan, A.F.N., *Lifecycle GHG emissions of palm biodiesel: Unintended market effects negate direct benefits of the Malaysian Economic Transformation Plan (ETP)*. Energy Policy, 2017. **104**: p. 56–65.
211. de Souza, S.P., S. Pacca, M.T. de Ávila, and J.L.B. Borges, *Greenhouse gas emissions and energy balance of palm oil biofuel*. Renewable Energy, 2010. **35**(11): p. 2552–2561.
212. Harsono, S.S., A. Prochnow, P. Grundmann, A. Hansen, et al., *Energy balances and greenhouse gas emissions of palm oil biodiesel in Indonesia*. GCB Bioenergy, 2012. **4**(2): p. 213–228.

213. Pehnelt, G. and C. Vietze, *Recalculating GHG emissions saving of palm oil biodiesel*. Environment, Development and Sustainability, 2013. **15**(2): p. 429-479.
214. Hansen, S., *Feasibility Study of Performing an Life Cycle Assessment on Crude Palm Oil Production in Malaysia (9 pp)*. The International Journal of Life Cycle Assessment, 2007. **12**(1): p. 50-58.
215. Ukaew, S., E. Beck, D.W. Archer, and D.R. Shonnard, *Estimation of soil carbon change from rotation cropping of rapeseed with wheat in the hydrotreated renewable jet life cycle*. The International Journal of Life Cycle Assessment, 2015. **20**(5): p. 608-622.
216. Yee, K.F., K.T. Tan, A.Z. Abdullah, and K.T. Lee, *Life cycle assessment of palm biodiesel: Revealing facts and benefits for sustainability*. Applied Energy, 2009. **86**, Supplement 1: p. S189-S196.
217. Gonzalez-Garcia, S., D. Garcia-Rey, and A. Hospido, *Environmental life cycle assessment for rapeseed-derived biodiesel*. International Journal of Life Cycle Assessment, 2013. **18**(1): p. 61-76.
218. Herrmann, I.T., A. Jørgensen, S. Bruun, and M.Z. Hauschild, *Potential for optimized production and use of rapeseed biodiesel. Based on a comprehensive real-time LCA case study in Denmark with multiple pathways*. The International Journal of Life Cycle Assessment, 2013. **18**(2): p. 418-430.
219. Kalnes, T.N., K.P. Koers, T. Marker, and D.R. Shonnard, *A Techno-economic and Environmental Life Cycle Comparison of Green Diesel to Biodiesel and Syndiesel*. Environmental Progress & Sustainable Energy, 2009. **28**(1): p. 111-120.
220. Stephenson, A.L., H. von Blottnitz, A.C. Brent, J.S. Dennis, et al., *Global Warming Potential and Fossil-Energy Requirements of Biodiesel Production Scenarios in South Africa*. Energy & Fuels, 2010. **24**(4): p. 2489-2499.
221. Iriarte, A., J. Rieradevall, and X. Gabarrell, *Transition towards a more environmentally sustainable biodiesel in South America: The case of Chile*. Applied Energy, 2012. **91**(1): p. 263-273.
222. Harding, K.G., J.S. Dennis, H. von Blottnitz, and S.T.L. Harrison, *A life-cycle comparison between inorganic and biological catalysis for the production of biodiesel*. Journal of Cleaner Production, 2008. **16**(13): p. 1368-1378.
223. Fernández-Tirado, F., C. Parra-López, and M. Romero-Gámez, *Life cycle assessment of biodiesel in Spain: Comparing the environmental sustainability of Spanish production versus Argentinean imports*. Energy for Sustainable Development, 2016. **33**: p. 36-52.
224. Tonini, D. and T. Astrup, *LCA of biomass-based energy systems: A case study for Denmark*. Applied Energy, 2012. **99**: p. 234-246.
225. Sieverding, H.L., L.M. Bailey, T.J. Hengen, D.E. Clay, et al., *Meta-Analysis of Soybean-based Biodiesel*. Journal of Environmental Quality, 2015. **44**(4): p. 1038-1048.
226. Garrain, D., I. Herrera, Y. Lechon, and C. Lago, *Well-to-Tank environmental analysis of a renewable diesel fuel from vegetable oil through co-processing in a hydrotreatment unit*. Biomass & Bioenergy, 2014. **63**: p. 239-249.
227. Hou, J., P. Zhang, X. Yuan, and Y. Zheng, *Life cycle assessment of biodiesel from soybean, jatropha and microalgae in China conditions*. Renewable & Sustainable Energy Reviews, 2011. **15**(9): p. 5081-5091.
228. Iriarte, A. and P. Villalobos, *Greenhouse gas emissions and energy balance of sunflower biodiesel: Identification of its key factors in the supply chain*. Resources Conservation and Recycling, 2013. **73**: p. 46-52.
229. Spinelli, D., S. Jez, R. Pogni, and R. Basosi, *Environmental and life cycle analysis of a biodiesel production line from sunflower in the Province of Siena (Italy)*. Energy Policy, 2013. **59**: p. 492-506.
230. Acquaye, A.A., T. Wiedmann, K. Feng, R.H. Crawford, et al., *Identification of 'Carbon Hot-Spots' and Quantification of GHG Intensities in the Biodiesel Supply Chain Using Hybrid LCA and Structural Path Analysis*. Environmental Science & Technology, 2011. **45**(6): p. 2471-2478.
231. Guo, M., J. Littlewood, J. Joyce, and R. Murphy, *The environmental profile of bioethanol produced from current and potential future poplar feedstocks in the EU*. Green Chemistry, 2014. **16**(11): p. 4680-4695.
232. Wang, L., J. Littlewood, and R.J. Murphy, *Environmental sustainability of bioethanol production from wheat straw in the UK*. Renewable & Sustainable Energy Reviews, 2013. **28**: p. 715-725.
233. Repo, A., H. Böttcher, G. Kindermann, and J. Liski, *Sustainability of forest bioenergy in Europe: land-use-related carbon dioxide emissions of forest harvest residues*. GCB Bioenergy, 2015. **7**(4): p. 877-887.
234. Warren Raffa, D., A. Bogdanski, and P. Tittonell, *How does crop residue removal affect soil organic carbon and yield? A hierarchical analysis of management and environmental factors*. Biomass and Bioenergy, 2015. **81**: p. 345-355.
235. Zhao, G., B.A. Bryan, D. King, Z. Luo, et al., *Sustainable limits to crop residue harvest for bioenergy: maintaining soil carbon in Australia's agricultural lands*. GCB Bioenergy, 2015. **7**(3): p. 479-487.
236. van Eijck, J., H. Romijn, A. Balkema, and A. Faaij, *Global experience with jatropha cultivation for bioenergy: An assessment of socio-economic and environmental aspects*. Renewable & Sustainable Energy Reviews, 2014. **32**: p. 869-889.

237. Shonnard, D.R., B. Klemetsrud, J. Sacramento-Rivero, F. Navarro-Pineda, et al., *A Review of Environmental Life Cycle Assessments of Liquid Transportation Biofuels in the Pan American Region*. Environmental Management, 2015. **56**(6): p. 1356-1376.
238. Escobar, N., J. Ribal, G. Clemente, and N. Sanjuan, *Consequential LCA of two alternative systems for biodiesel consumption in Spain, considering uncertainty*. Journal of Cleaner Production, 2014. **79**: p. 61-73.
239. Peters, J.F., D. Iribarren, and J. Dufour, *Simulation and life cycle assessment of biofuel production via fast pyrolysis and hydrouprgrading*. Fuel, 2015. **139**: p. 441-456.
240. Budsberg, E., J. Crawford, R. Gustafson, R. Bura, et al., *Ethanologens vs. acetogens: Environmental impacts of two ethanol fermentation pathways*. Biomass & Bioenergy, 2015. **83**: p. 23-31.
241. Brynolf, S., E. Fridell, and K. Andersson, *Environmental assessment of marine fuels: liquefied natural gas, liquefied biogas, methanol and bio-methanol*. Journal of Cleaner Production, 2014. **74**: p. 86-95.
242. Guo, M., C. Li, G. Facciotto, S. Bergante, et al., *Bioethanol from poplar clone Imola: an environmentally viable alternative to fossil fuel?* Biotechnology for Biofuels, 2015. **8**.
243. Falano, T., H.K. Jeswani, and A. Azapagic, *Assessing the environmental sustainability of ethanol from integrated biorefineries*. Biotechnology Journal, 2014. **9**(6): p. 753-765.
244. Reyes Valle, C., A.L. Villanueva Perales, F. Vidal-Barrero, and P. Ollero, *Integrated economic and life cycle assessment of thermochemical production of bioethanol to reduce production cost by exploiting excess of greenhouse gas savings*. Applied Energy, 2015. **148**: p. 466-475.
245. Iribarren, D., J.F. Peters, and J. Dufour, *Life cycle assessment of transportation fuels from biomass pyrolysis*. Fuel, 2012. **97**: p. 812-821.
246. González-García, S., D. Iribarren, A. Susmozas, J. Dufour, et al., *Life cycle assessment of two alternative bioenergy systems involving Salix spp. biomass: Bioethanol production and power generation*. Applied Energy, 2012. **95**: p. 111-122.
247. Weinberg, J. and M. Kaltschmitt, *Life cycle assessment of mobility options using wood based fuels - Comparison of selected environmental effects and costs*. Bioresource Technology, 2013. **150**: p. 420-428.
248. Maleche, E., R. Glaser, T. Marker, and D. Shonnard, *A Preliminary Life Cycle Assessment of Biofuels Produced by the IH2 (TM) Process*. Environmental Progress & Sustainable Energy, 2014. **33**(1): p. 322-329.
249. Slade, R., A. Bauen, and N. Shah, *The greenhouse gas emissions performance of cellulosic ethanol supply chains in Europe*. Biotechnology for Biofuels, 2009. **2**: p. 15-15.
250. Daystar, J., C. Reeb, R. Gonzalez, R. Venditti, et al., *Environmental life cycle impacts of cellulosic ethanol in the Southern US produced from loblolly pine, eucalyptus, unmanaged hardwoods, forest residues, and switchgrass using a thermochemical conversion pathway*. Fuel Processing Technology, 2015. **138**: p. 164-174.
251. Zaines, G.G., K. Soratana, C.L. Harden, A.E. Landis, et al., *Biofuels via Fast Pyrolysis of Perennial Grasses: A Life Cycle Evaluation of Energy Consumption and Greenhouse Gas Emissions*. Environmental Science & Technology, 2015. **49**(16): p. 10007-10018.
252. Scown, C.D., W.W. Nazaroff, U. Mishra, B. Strogen, et al., *Lifecycle greenhouse gas implications of US national scenarios for cellulosic ethanol production*. Environ Res Lett, 2012. **7**.
253. Choudhary, S., S. Liang, H. Cai, G.A. Keoleian, et al., *Reference and functional unit can change bioenergy pathway choices*. The International Journal of Life Cycle Assessment, 2014. **19**(4): p. 796-805.
254. Sinistore, J.C., D.J. Reinemann, R.C. Izaurralde, K.R. Cronin, et al., *Life Cycle Assessment of Switchgrass Cellulosic Ethanol Production in the Wisconsin and Michigan Agricultural Contexts*. Bioenergy Research, 2015. **8**(3): p. 897-909.
255. Bai, Y., L. Luo, and E. van der Voet, *Life cycle assessment of switchgrass - derived ethanol as transport fuel*. The International Journal of Life Cycle Assessment, 2010. **15**(5): p. 468-477.
256. Argo, A.M., E.C.D. Tan, D. Inman, M.H. Langholtz, et al., *Investigation of biochemical biorefinery sizing and environmental sustainability impacts for conventional bale system and advanced uniform biomass logistics designs*. Biofuels Bioproducts & Biorefining-Biofpr, 2013. **7**(3): p. 282-302.
257. Patrizi, N., D. Caro, F.M. Pulselli, A.B. Bjerre, et al., *Environmental feasibility of partial substitution of gasoline with ethanol in the Province of Siena (Italy)*. Journal of Cleaner Production, 2013. **47**: p. 388-395.
258. Silalertruksa, T. and S.H. Gheewala, *A comparative LCA of rice straw utilization for fuels and fertilizer in Thailand*. Bioresource Technology, 2013. **150**: p. 412-419.



259. Kumar, D. and G.S. Murthy, *Life cycle assessment of energy and GHG emissions during ethanol production from grass straws using various pretreatment processes*. The International Journal of Life Cycle Assessment, 2012. **17**(4): p. 388-401.
260. Dang, Q., C. Yu, and Z. Luo, *Environmental life cycle assessment of bio-fuel production via fast pyrolysis of corn stover and hydroprocessing*. Fuel, 2014. **131**: p. 36-42.
261. Nguyen, L., K.G. Cafferty, E.M. Searcy, and S. Spatari, *Uncertainties in Life Cycle Greenhouse Gas Emissions from Advanced Biomass Feedstock Logistics Supply Chains in Kansas*. Energies, 2014. **7**(11): p. 7125-7146.
262. Palma-Rojas, S., A. Caldeira-Pires, and J.M. Nogueira, *Environmental and economic hybrid life cycle assessment of bagasse-derived ethanol produced in Brazil*. The International Journal of Life Cycle Assessment, 2017. **22**(3): p. 317-327.
263. Renouf, M.A., R.J. Pagan, and M.K. Wegener, *Life cycle assessment of Australian sugarcane products with a focus on cane processing*. The International Journal of Life Cycle Assessment, 2011. **16**(2): p. 125-137.
264. Cox, K., M. Renouf, A. Dargan, C. Turner, et al., *Environmental life cycle assessment (LCA) of aviation biofuel from microalgae, Pongamia pinnata, and sugarcane molasses*. Biofuels Bioproducts & Biorefining-Biofpr, 2014. **8**(4): p. 579-593.
265. Gonzalez-Garcia, S., M. Teresa Moreira, and G. Feijoo, *Comparative environmental performance of lignocellulosic ethanol from different feedstocks*. Renewable & Sustainable Energy Reviews, 2010. **14**(7): p. 2077-2085.
266. Singh, A. and S.I. Olsen, *Comparison of Algal Biodiesel Production Pathways Using Life Cycle Assessment Tool, in Life Cycle Assessment of Renewable Energy Sources*. A. Singh, D. Pant, and S.I. Olsen, Editors. 2013. p. 145-168.
267. Orfield, N.D., R.B. Levine, G.A. Keoleian, S.A. Miller, et al., *Growing Algae for Biodiesel on Direct Sunlight or Sugars: A Comparative Life Cycle Assessment*. ACS Sustainable Chemistry & Engineering, 2015. **3**(3): p. 386-395.
268. Chowdhury, R. and F. Freire, *Bioenergy production from algae using dairy manure as a nutrient source: Life cycle energy and greenhouse gas emission analysis*. Applied Energy, 2015. **154**: p. 1112-1121.
269. Mu, D., M. Min, B. Krohn, K.A. Mullins, et al., *Life Cycle Environmental Impacts of Wastewater-Based Algal Biofuels*. Environmental Science & Technology, 2014. **48**(19): p. 11696-11704.
270. Eshon, B., J.H.Y. Katima, and E. Kituyi, *Greenhouse gas emissions and energy balances of jatropha biodiesel as an alternative fuel in Tanzania*. Biomass & Bioenergy, 2013. **58**: p. 95-103.
271. Hagman, J., M. Nerentorp, R. Arvidsson, and S. Molander, *Do biofuels require more water than do fossil fuels? Life cycle-based assessment of jatropha oil production in rural Mozambique*. Journal of Cleaner Production, 2013. **53**: p. 176-185.
272. Ndong, R., M. Montrejaud-Vignoles, O. Saint Girons, B. Gabrielle, et al., *Life cycle assessment of biofuels from Jatropha curcas in West Africa: a field study*. GCB Bioenergy, 2009. **1**(3): p. 197-210.
273. Ajayebi, A., E. Gnansounou, and J.K. Raman, *Comparative life cycle assessment of biodiesel from algae and jatropha: A case study of India*. Bioresource Technology, 2013. **150**: p. 429-437.
274. Kumar, S., J. Singh, S.M. Nanoti, and M.O. Garg, *A comprehensive life cycle assessment (LCA) of Jatropha biodiesel production in India*. Bioresource Technology, 2012. **110**: p. 723-729.
275. Li, X. and E. Mupondwa, *Life cycle assessment of camelina oil derived biodiesel and jet fuel in the Canadian Prairies*. Science of the Total Environment, 2014. **481**: p. 17-26.
276. Krohn, B.J. and M. Fripp, *A life cycle assessment of biodiesel derived from the "niche filling" energy crop camelina in the USA*. Applied Energy, 2012. **92**: p. 92-98.
277. Caldeira, C., J. Queirós, A. Noshadravan, and F. Freire, *Incorporating uncertainty in the life cycle assessment of biodiesel from waste cooking oil addressing different collection systems*. Resources, Conservation and Recycling, 2016. **112**: p. 83-92.
278. Talens Peiró, L., L. Lombardi, G. Villalba Méndez, and X. Gabarrell i Durany, *Life cycle assessment (LCA) and exergetic life cycle assessment (ELCA) of the production of biodiesel from used cooking oil (UCO)*. Energy, 2010. **35**(2): p. 889-893.
279. Dufour, J. and D. Iribarren, *Life cycle assessment of biodiesel production from free fatty acid-rich wastes*. Renewable Energy, 2012. **38**(1): p. 155-162.
280. Thamsiroj, T. and J.D. Murphy, *The impact of the life cycle analysis methodology on whether biodiesel produced from residues can meet the EU sustainability criteria for biofuel facilities constructed after 2017*. Renewable Energy, 2011. **36**(1): p. 50-63.
281. Souza, D.d.P., F.M. Mendonca, K.R. Alves Nunes, and R. Valle, *Environmental and Socioeconomic Analysis of Producing Biodiesel from Used Cooking Oil in Rio de Janeiro The Case of the Copacabana District*. Journal of Industrial Ecology, 2012. **16**(4): p. 655-664.

282. Pleanjai, S., S.H. Gheewala, and S. Garivait, *Greenhouse gas emissions from production and use of used cooking oil methyl ester as transport fuel in Thailand*. Journal of Cleaner Production, 2009. **17**(9): p. 873–876.
283. Mortimer, N., A.K.F. Evans, O. Mwabonje, C.L. Whittaker, et al., *Comparison of the Greenhouse Gas Benefits Resulting from Use of Vegetable Oils for Electricity, Heat, Transport and Industrial Purposes*. 2010, NNFFC.
284. Pragma, N. and K.K. Pandey, *Life cycle assessment of green diesel production from microalgae*. Renewable Energy, 2016. **86**: p. 623–632.
285. Medeiros, D.L., E.A. Sales, and A. Kiperstok, *Energy production from microalgae biomass: carbon footprint and energy balance*. Journal of Cleaner Production, 2015. **96**: p. 493–500.
286. Adesanya, V.O., E. Cadena, S.A. Scott, and A.G. Smith, *Life cycle assessment on microalgal biodiesel production using a hybrid cultivation system*. Bioresource Technology, 2014. **163**: p. 343–355.
287. Yuan, J., A. Kendall, and Y. Zhang, *Mass balance and life cycle assessment of biodiesel from microalgae incorporated with nutrient recycling options and technology uncertainties*. Global Change Biology Bioenergy, 2015. **7**(6): p. 1245–1259.
288. Campbell, P.K., T. Beer, and D. Batten, *Life cycle assessment of biodiesel production from microalgae in ponds*. Bioresource Technology, 2011. **102**(1): p. 50–56.
289. Stephenson, A.L., E. Kazamia, J.S. Dennis, C.J. Howe, et al., *Life-Cycle Assessment of Potential Algal Biodiesel Production in the United Kingdom: A Comparison of Raceways and Air-Lift Tubular Bioreactors*. Energy & Fuels, 2010. **24**(7): p. 4062–4077.
290. Sander, K. and G.S. Murthy, *Life cycle analysis of algae biodiesel*. The International Journal of Life Cycle Assessment, 2010. **15**(7): p. 704–714.
291. Holma, A., K. Koponen, R. Antikainen, L. Lardon, et al., *Current limits of life cycle assessment framework in evaluating environmental sustainability - case of two evolving biofuel technologies*. Journal of Cleaner Production, 2013. **54**: p. 215–228.
292. Woertz, I.C., J.R. Benemann, N. Du, S. Unnasch, et al., *Life Cycle GHG Emissions from Microalgal Biodiesel - A CA-GREET Model*. Environmental Science & Technology, 2014. **48**(11): p. 6060–6068.
293. Soratana, K., W.F. Harper, Jr., and A.E. Landis, *Microalgal biodiesel and the Renewable Fuel Standard's greenhouse gas requirement*. Energy Policy, 2012. **46**: p. 498–510.
294. Arvidsson, R., K. Fransson, M. Froling, M. Svanstrom, et al., *Energy use indicators in energy and life cycle assessments of biofuels: review and recommendations*. Journal of Cleaner Production, 2012. **31**: p. 54–61.
295. Zaimes, G.G. and V. Khanna, *Assessing the critical role of ecological goods and services in microalgal biofuel life cycles*. Rsc Advances, 2014. **4**(85): p. 44980–44990.
296. Slade, R. and A. Bauen, *Micro-algae cultivation for biofuels: Cost, energy balance, environmental impacts and future prospects*. Biomass & Bioenergy, 2013. **53**: p. 29–38.
297. Ponnusamy, S., H.K. Reddy, T. Muppaneni, C.M. Downes, et al., *Life cycle assessment of biodiesel production from algal bio-crude oils extracted under subcritical water conditions*. Bioresource Technology, 2014. **170**: p. 454–461.
298. Pardo-Cardenas, Y., I. Herrera-Orozco, A.-D. Gonzalez-Delgado, and V. Kafarov, *Environmental assessment of microalgae biodiesel production in Colombia: comparison of three oil extraction systems*. Ct&F-Ciencia Tecnologia Y Futuro, 2013. **5**(2): p. 85–100.
299. Scacchi, C.C.O., S. Gonzalez-Garcia, S. Caserini, and L. Rigamonti, *Greenhouse gases emissions and energy use of wheat grain-based bioethanol fuel blends*. Science of the Total Environment, 2010. **408**(21): p. 5010–5018.
300. Kamahara, H., U. Hasanudin, A. Widiyanto, R. Tachibana, et al., *Improvement potential for net energy balance of biodiesel derived from palm oil: A case study from Indonesian practice*. Biomass and Bioenergy, 2010. **34**(12): p. 1818–1824.
301. Queiroz, A.G., L. Franca, and M.X. Ponte, *The life cycle assessment of biodiesel from palm oil ("dende") in the Amazon*. Biomass & Bioenergy, 2012. **36**: p. 50–59.
302. Dominguez-Faus, R., S.E. Powers, J.G. Burken, and P.J. Alvarez, *The Water Footprint of Biofuels: A Drink or Drive Issue?* Environmental Science & Technology, 2009. **43**(9): p. 3005–3010.
303. Hammond, G.P. and B. Li, *Environmental and resource burdens associated with world biofuel production out to 2050: footprint components from carbon emissions and land use to waste arisings and water consumption*. GCB Bioenergy, 2016. **8**(5): p. 894–908.
304. Jeswani, H.K. and A. Azapagic, *Water footprint: methodologies and a case study for assessing the impacts of water use*. Journal of Cleaner Production, 2011. **19**(12): p. 1288–1299.

305. Gerbens-Leenes, W., A.Y. Hoekstra, and T.H. van der Meer, *The water footprint of bioenergy*. Proceedings of the National Academy of Sciences, 2009. **106**(25): p. 10219-10223.
306. Berger, M., S. Pfister, V. Bach, and M. Finkbeiner, *Saving the Planet's Climate or Water Resources? The Trade-Off between Carbon and Water Footprints of European Biofuels*. Sustainability, 2015. **7**(6): p. 6665-6683.
307. Gerbens-Leenes, P.W., L. Xu, G.J. de Vries, and A.Y. Hoekstra, *The blue water footprint and land use of biofuels from algae*. Water Resources Research, 2014. **50**(11): p. 8549-8563.
308. Webb, A. and D. Coates, *Biofuels and Biodiversity, in Montreal, Technical Series No. 65, 69 pages*. 2012, Secretariat of the Convention on Biological Diversity.
309. Liu, Y., Y. Xu, F. Zhang, J. Yun, et al., *The impact of biofuel plantation on biodiversity: a review*. Chinese Science Bulletin, 2014. **59**(34): p. 4639-4651.
310. IEA, *Sustainable Production of Second-Generation Biofuels - Potential and perspectives in major economies and developing countries*. 2010, International Energy Agency: Paris.
311. Rowe, R.L., N.R. Street, and G. Taylor, *Identifying potential environmental impacts of large-scale deployment of dedicated bioenergy crops in the UK*. Renewable and Sustainable Energy Reviews, 2009. **13**(1): p. 271-290.
312. The Royal Society, *Sustainable Biofuels: Prospects and Challenges*. 2008, Royal Society: London.
313. Butler, B.J. and D.N. Wear, *Forest Ownership Dynamics of Southern Forests*, in The Southern Forest Futures Project: Technical Report. D.N. Wear and J.G. Greis, Editors. 2013, United States Department of Agriculture. Forest Service, Research and Development, Southern Research Station. [www.treeseearch.fs.fed.us/pubs/44183](http://www.treeseearch.fs.fed.us/pubs/44183). p. 103-122
314. Miner, R.A., R.C. Abt, J.L. Bowyer, M.A. Buford, et al., *Forest Carbon Accounting Considerations in US Bioenergy Policy*. Journal of Forestry, 2014. **112**(6): p. 591-606.
315. Riffell, S., J. Verschuyf, D. Miller, and T.B. Wigley, *Biofuel harvests, coarse woody debris, and biodiversity - A meta-analysis*. Forest Ecology and Management, 2011. **261**(4): p. 878-887.
316. Mortimer, N., *Carbon life cycle assessment of bioenergy for policy analysis, formulation and implementation: a briefing paper*. 2016: North Energy Associates Limited.
317. Yang, Y., J. Bae, J. Kim, and S. Suh, *Replacing Gasoline with Corn Ethanol Results in Significant Environmental Problem-Shifting*. Environmental Science & Technology, 2012. **46**(7): p. 3671-3678.
318. Ripa, M., C. Buonaio, S. Mellino, G. Fiorentino, et al., *Recycling Waste Cooking Oil into Biodiesel: A Life Cycle Assessment*. International Journal of Performability Engineering, 2014. **10**(4): p. 347-356.
319. Kalaivani, K., G. Ravikumar, and N. Balasubramanian, *Environmental Impact Studies of Biodiesel Production From *Jatropha curcas* in India by Life Cycle Assessment*. Environmental Progress & Sustainable Energy, 2014. **33**(4): p. 1340-1349.
320. Scarlat, N. and J.-F. Dallemand, *Recent developments of biofuels/bioenergy sustainability certification: A global overview*. Energy Policy, 2011. **39**(3): p. 1630-1646.
321. Diaz-Chavez, R.A., *Assessing biofuels: Aiming for sustainable development or complying with the market?* Energy Policy, 2011. **39**(10): p. 5763-5769.
322. International Trade Centre, *Standards map*. [www.standardsmap.org/](http://www.standardsmap.org/)
323. International Sustainability and Carbon Certification (ISCC), *ISCC 202: Sustainability Requirements. Version 3.0*. 2016. [www.iscc-system.org/en/certification-process/isccsystemdocuments/iscc-eu/](http://www.iscc-system.org/en/certification-process/isccsystemdocuments/iscc-eu/)
324. Roundtable on Sustainable Biomaterials (RSB), *RSB Principles and Criteria*. 2016. [http://rsb.org/wp-content/uploads/2017/03/RSB-STD-01-001\\_Principles\\_and\\_Criteria.pdf](http://rsb.org/wp-content/uploads/2017/03/RSB-STD-01-001_Principles_and_Criteria.pdf)
325. Raman, S., A. Mohr, R. Helliwell, B. Ribeiro, et al., *Integrating social and value dimensions into sustainability assessment of lignocellulosic biofuels*. Biomass and Bioenergy, 2015. **82**: p. 49-62.
326. Ribeiro, B.E., *Beyond commonplace biofuels: Social aspects of ethanol*. Energy Policy, 2013. **57**: p. 355-362.
327. Scovronick, N. and P. Wilkinson, *Health impacts of liquid biofuel production and use: A review*. Global Environmental Change, 2014. **24**: p. 155-164.
328. Oxfam, *Burning Land, Burning the Climate: The biofuel industry's capture of EU bioenergy policy*, in Oxfam Briefing Paper. 2016. [www.oxfam.org/en/research/burning-land-burning-climate](http://www.oxfam.org/en/research/burning-land-burning-climate)
329. Laborde, D. and S. Msangi, *Chapter 5: Biofuels, Environment and Food: The Story Gets More Complicated*, in 2011 Global Food Policy Report. 2011, International Food Policy Research Institute (IFPRI). [www.ifpri.org/publication/biofuels-environment-and-food-story-gets-more-complicated](http://www.ifpri.org/publication/biofuels-environment-and-food-story-gets-more-complicated)
330. Bastianin, A., M. Galeotti, and M. Manera, *Biofuels and Food Prices: Searching for the Causal Link*. 2013, Fondazione Eni Enrico Mattei.



331. Ecofys, *Biofuels and food security: Risks and opportunities*. 2013. [www.ecofys.com/files/files/ecofys-2013-biofuels-and-food-security.pdf](http://www.ecofys.com/files/files/ecofys-2013-biofuels-and-food-security.pdf)
332. High Level Panel of Experts (HLPE), Committee on World Food Security, *Biofuels and food security. A report by the High Level Panel of Experts on Food Security and Nutrition of the Committee on World Food Security*. 2013, World Food Security, Rome. [www.fao.org/fileadmin/user\\_upload/hlpe/hlpe\\_documents/HLPE\\_Reports/HLPE-Report-5\\_Biofuels\\_and\\_food\\_security.pdf](http://www.fao.org/fileadmin/user_upload/hlpe/hlpe_documents/HLPE_Reports/HLPE-Report-5_Biofuels_and_food_security.pdf)
333. Mitchell, D., *A note on rising food prices in Policy Research Working Paper No. 4682*. 2008, World Bank. Washington, DC.
334. Monteiro, N., I. Altman, and S. Lahiri, *The impact of ethanol production on food prices: The role of interplay between the U.S. and Brazil*. *Energy Policy*, 2012. **41**: p. 193-199.
335. H elaine, S., R. M'barek, and H. Gay, *Impacts of the EU biofuel policy on agricultural markets and land use: Modelling assessment with AGLINK-COSIMO (2012 version)*. 2013, European Commission. <http://ftp.jrc.es/EURdoc/JRC83936.pdf>
336. Locke, A., S. Wiggins, G. Henley, and S. Keats, *Diverting grain from animal feed to biofuels: can it protect the poor from high food prices?* 2013, Overseas Development Institute (ODI). [www.odi.org/sites/odi.org.uk/files/odi-assets/publications-opinion-files/8343.pdf](http://www.odi.org/sites/odi.org.uk/files/odi-assets/publications-opinion-files/8343.pdf)
337. Osseweijer, P., H.K. Watson, F.X. Johnson, M. Batistella, et al., *Bioenergy and Food Security, in Bioenergy and Sustainability: Bridging the Gaps*. G.M. Souza, et al., Editors. 2015. [http://bioenfapesp.org/scopebioenergy/images/chapters/bioen-scope\\_chapter04.pdf](http://bioenfapesp.org/scopebioenergy/images/chapters/bioen-scope_chapter04.pdf). p. 90-136
338. Kline, K.L., S. Msangi, V.H. Dale, J. Woods, et al., *Reconciling food security and bioenergy: priorities for action*. *GCB Bioenergy*, 2017. **9**(3): p. 557-576.
339. Feed The Future, *The U.S. Government's Global Hunger and Food Security Initiative*. [www.feedthefuture.gov/](http://www.feedthefuture.gov/)
340. World Bank, *Global Monitoring Report 2015/2016: Development Goals in an Era of Demographic Change*. 2016. <http://pubdocs.worldbank.org/en/503001444058224597/Global-Monitoring-Report-2015.pdf>
341. Woods, J., L.R. Lynd, M. Laser, M. Batistella, et al., *Land and bioenergy, in Bioenergy and Sustainability: Bridging the Gaps*. G.M. Souza, et al., Editors. 2015. [http://catalogue.unccd.int/667\\_bioen-scope\\_chapter09.pdf](http://catalogue.unccd.int/667_bioen-scope_chapter09.pdf). p. 259-300
342. Richards, B.K., C.R. Stoof, I.J. Cary, and P.B. Woodbury, *Reporting on Marginal Lands for Bioenergy Feedstock Production: a Modest Proposal*. *BioEnergy Research*, 2014. **7**(3): p. 1060-1062.
343. Bailey, R., *The Trouble with Biofuels: Costs and Consequences of Expanding Biofuel Use in the United Kingdom. Energy, Environment and Resources EER PP 2013/01*. 2013, Chatham House. [www.chathamhouse.org/publications/papers/view/190783](http://www.chathamhouse.org/publications/papers/view/190783)
344. Charles, C., I. Gerasimchuk, R. Bridle, T. Moerenhout, et al., *Biofuels—At What Cost? A review of costs and benefits of EU biofuel policies*. 2013, The International Institute for Sustainable Development.
345. Renewable Energy Association (REA), *UK Biofuels Sector - Key Facts & Figures*. 2013, Renewable Energy Association. [www.r-e-a.net/resources/rea-publications](http://www.r-e-a.net/resources/rea-publications)
346. NNFCC, *Use of sustainably-sourced residue and waste streams for advanced biofuels production in the European Union: rural economic impacts and potential for job creation: A Report for the European Climate Foundation*. 2013. [www.nnfcc.co.uk/files/mydocs/14\\_2\\_18%20%20ECF%20Advanced%20Biofuels\\_NNFCC%20published%20v2.pdf](http://www.nnfcc.co.uk/files/mydocs/14_2_18%20%20ECF%20Advanced%20Biofuels_NNFCC%20published%20v2.pdf)
347. Bright, R.M., A.H. Str omman, and T.R. Hawkins, *Environmental Assessment of Wood-Based Biofuel Production and Consumption Scenarios in Norway*. *Journal of Industrial Ecology*, 2010. **14**(3): p. 422-439.
348. Tr omborg, E. and B. Solberg, *Forest sector impacts of the increased use of wood in energy production in Norway*. *Forest Policy and Economics*, 2010. **12**(1): p. 39-47.
349. Sj alie, H.K., K. Bysheim, A.Q. Nyruud, P.O. Fl ete, et al., *Future Development of the Norwegian Forest Industry, Based on Industry Expectations*. *Forest Products Journal*, 2015. **65**(3-4): p. 148-158.
350. Nuffield Council on Bioethics, *Biofuels: ethical issues*. 2011. <http://nuffieldbioethics.org/project/biofuels-0/>
351. Ekener-Petersen, E., J. H oglund, and G. Finnveden, *Screening potential social impacts of fossil fuels and biofuels for vehicles*. *Energy Policy*, 2014. **73**: p. 416-426.
352. German, L., G.C. Schoneveld, and P. Pacheco, *Local social and environmental impacts of biofuels: global comparative assessment and implications for governance*. *Ecology and Society*, 2011. **16**(4): p. 29-32.
353. Creutzig, F., N.H. Ravindranath, G. Berndes, S. Bolwig, et al., *Bioenergy and climate change mitigation: an assessment*. *GCB Bioenergy*, 2015. **7**(5): p. 916-944.

354. Tessum, C.W., J.D. Marshall, and J.D. Hill, *A Spatially and Temporally Explicit Life Cycle Inventory of Air Pollutants from Gasoline and Ethanol in the United States*. Environmental Science & Technology, 2012. **46**(20): p. 11408-11417.
355. Scovronick, N., D. França, M. Alonso, C. Almeida, et al., *Air Quality and Health Impacts of Future Ethanol Production and Use in São Paulo State, Brazil*. International Journal of Environmental Research and Public Health, 2016. **13**(7): p. 695.
356. Le Blond, J.S., S. Woskie, C.J. Horwell, and B.J. Williamson, *Particulate matter produced during commercial sugarcane harvesting and processing: A respiratory health hazard?* Atmospheric Environment, 2017. **149**: p. 34-46.
357. Arbex, M.A., L.A.A. Pereira, R. Carvalho-Oliveira, P.H.d.N. Saldiva, et al., *The effect of air pollution on pneumonia-related emergency department visits in a region of extensive sugar cane plantations: a 30-month time-series study*. Journal of Epidemiology and Community Health, 2014. **68**(7): p. 669-674.
358. Silveira, H.C.S., M. Schmidt-Carrijo, E.H. Seidel, C. Scapulatempo-Neto, et al., *Emissions generated by sugarcane burning promote genotoxicity in rural workers: a case study in Barretos, Brazil*. Environmental Health, 2013. **12**(1): p. 87.
359. Air Quality Expert Group, *Road Transport Biofuels: Impact on UK Air Quality*. 2011, DEFRA.
360. Beer, T., J. Carras, D. Worth, N. Coplin, et al., *The Health Impacts of Ethanol Blend Petrol*. Energies, 2011. **4**(2): p. 352.
361. Wallington, T.J., J.E. Anderson, E.M. Kurtz, and P.J. Tennison, *Biofuels, vehicle emissions, and urban air quality*. Faraday Discussions, 2016. **189**(0): p. 121-136.
362. Sundvor, I. and S. López-Aparicio, *Impact of bioethanol fuel implementation in transport based on modelled acetaldehyde concentration in the urban environment*. Science of the Total Environment, 2014. **496**: p. 100-106.
363. Rouleau, M., M. Egyed, B. Taylor, J. Chen, et al., *Human Health Impacts of Biodiesel Use in On-Road Heavy Duty Diesel Vehicles in Canada*. Environmental Science & Technology, 2013. **47**(22): p. 13113-13121.
364. Hutter, H.-P., M. Kundi, H. Moshhammer, J. Shelton, et al., *Replacing Fossil Diesel by Biodiesel Fuel: Expected Impact on Health*. Archives of Environmental & Occupational Health, 2015. **70**(1): p. 4-9.
365. Larcombe, A.N., A. Kicic, B.J. Mullins, and G. Knothe, *Biodiesel exhaust: The need for a systematic approach to health effects research*. Respirology, 2015. **20**(7): p. 1034-1045.
366. DfT, *Carbon and Sustainability Reporting Within the Renewable Transport Fuel Obligation - Requirements and Guidance*. 2008, Department for Transport: London.
367. United Nations Environment Programme (UNEP), *Guidelines for social life cycle assessment of products, UNEP/SETAC Life Cycle Initiative*. 2009, United Nations Environment Programme. [www.unep.org/pdf/DfTIE\\_PDFS/DTIx1164xPA-guidelines\\_sLCA.pdf](http://www.unep.org/pdf/DfTIE_PDFS/DTIx1164xPA-guidelines_sLCA.pdf)
368. Thornley, P. and P. Gilbert, *Biofuels: balancing risks and rewards*. Interface Focus, 2013. **3**(1).
369. Mangoyana, R.B., T.F. Smith, and R. Simpson, *A systems approach to evaluating sustainability of biofuel systems*. Renewable and Sustainable Energy Reviews, 2013. **25**: p. 371-380.
370. Demirbas, A., *Political, economic and environmental impacts of biofuels: A review*. Applied Energy, 2009. **86**, **Supplement 1**: p. S108-S117.
371. IRENA, *Road Transport: The Cost of Renewable Solutions*. 2013, International Renewable Energy Agency.
372. Ecofys, *How to advance cellulosic biofuels - Assessment of costs, investment options and policy support*. 2016.
373. Marques, P.A., *Note to the voluntary schemes that have been recognised by the Commission for demonstrating compliance with the sustainability criteria for biofuels*. 2014. [https://ec.europa.eu/energy/sites/ener/files/documents/2014\\_letter\\_wastes\\_residues.pdf](https://ec.europa.eu/energy/sites/ener/files/documents/2014_letter_wastes_residues.pdf)
374. Ecofys, *Trends in the UCO market*. 2013, Ecofys.
375. HGCA, *Regional emissions from biofuels cultivation: Revised report: December 2012*. 2012. [www.gov.uk/government/publications/regional-emissions-from-biofuels-cultivation](http://www.gov.uk/government/publications/regional-emissions-from-biofuels-cultivation)
376. DfT, *The Renewable Transport Fuel Obligations Order Proposed Amendments: Moving Britain Forward*. 2016, Department for Transport. [www.gov.uk/government/consultations/renewable-transport-fuel-obligation-proposed-changes-for-2017](http://www.gov.uk/government/consultations/renewable-transport-fuel-obligation-proposed-changes-for-2017)
377. DEFRA, *An introductory guide to valuing ecosystem services*. 2007, Department for Environment, Food and Rural Affairs. [www.gov.uk/government/publications/an-introductory-guide-to-valuing-ecosystem-services](http://www.gov.uk/government/publications/an-introductory-guide-to-valuing-ecosystem-services)
378. Parliamentary Office of Science and Technology (POST), *Ecosystem Services: POST Note no. 281*. 2007, Parliamentary Office of Science and Technology. [www.parliament.uk/documents/post/postpn281.pdf](http://www.parliament.uk/documents/post/postpn281.pdf)

379. DEFRA, *Safeguarding our soils: A strategy for England*. 2009, Department for Environment, Food and Rural Affairs. [www.gov.uk/government/publications/safeguarding-our-soils-a-strategy-for-england](http://www.gov.uk/government/publications/safeguarding-our-soils-a-strategy-for-england)
380. UK National Ecosystem Assessment, *UK National Ecosystem Assessment: Synthesis of Key Findings*. 2011. <http://uknea.unep-wcmc.org/Resources/tabid/82/Default.aspx>
381. POST, *Ecosystem service valuation: POST Note no. 378*. 2011, Parliamentary Office of Science and Technology. <http://researchbriefings.files.parliament.uk/documents/POST-PN-378/POST-PN-378.pdf>
382. UK National Ecosystem Assessment, *UK National Ecosystem Assessment (Follow on): Synthesis of Key Findings*. 2014. <http://uknea.unep-wcmc.org/Resources/tabid/82/Default.aspx>
383. DEFRA, *What nature can do for you: A practical introduction to making the most of natural services, assets and resources in policy and decision making*. 2015, Department for Environment, Food and Rural Affairs. [www.gov.uk/government/publications/what-nature-can-do-for-you](http://www.gov.uk/government/publications/what-nature-can-do-for-you)
384. Natural Capital Committee, *Improving natural capital: an assessment of progress*. 2017. [www.gov.uk/government/publications/natural-capital-committees-fourth-state-of-natural-capital-report](http://www.gov.uk/government/publications/natural-capital-committees-fourth-state-of-natural-capital-report)
385. Natural Capital Committee, *How to do it: a natural capital workbook*. 2017. [www.gov.uk/government/uploads/system/uploads/attachment\\_data/file/608849/ncc-natural-capital-workbook.pdf](http://www.gov.uk/government/uploads/system/uploads/attachment_data/file/608849/ncc-natural-capital-workbook.pdf)
386. Natural Capital Committee, *The economic case for investment in natural capital in England*. 2015. [www.gov.uk/government/publications/natural-capital-committee-research-investing-in-natural-capital](http://www.gov.uk/government/publications/natural-capital-committee-research-investing-in-natural-capital)
387. EFTEC, *Valuing Environmental Impacts: Practical Guidelines for the Use of Value Transfer in Policy and Project Appraisal*. 2009. [www.gov.uk/government/uploads/system/uploads/attachment\\_data/file/182376/vt-guidelines.pdf](http://www.gov.uk/government/uploads/system/uploads/attachment_data/file/182376/vt-guidelines.pdf)
388. EFTEC, *Valuing Environmental Impacts: Practical Guidelines for the Use of Value Transfer in Policy and Project Appraisal*. 2010. [www.gov.uk/government/uploads/system/uploads/attachment\\_data/file/182378/vt-tech-report.pdf](http://www.gov.uk/government/uploads/system/uploads/attachment_data/file/182378/vt-tech-report.pdf)
389. DEFRA, *Participatory and deliberative techniques to embed an ecosystems approach into decision making: An introductory guide*. 2011. [www.gov.uk/guidance/ecosystems-services](http://www.gov.uk/guidance/ecosystems-services)
390. Collingwood Environmental Planning, *Case study to develop tools and methodologies to deliver an ecosystem-based approach - Thames Gateway Green Grids*. 2008. <http://randd.defra.gov.uk/Default.aspx?Menu=Menu&Module=More&Location=None&Completed=0&ProjectID=14753>
391. Ashworth, P., S. Bolton, R. Edwards, A. Mole, et al., *Case study to develop tools and methodologies to deliver an ecosystems approach - Heysham to M6 link*. 2007. <http://randd.defra.gov.uk/Default.aspx?Menu=Menu&Module=More&Location=None&Completed=0&ProjectID=14755#Description>
392. Potschin, M., R. Fish, R. Haines-Young, C. Somper, et al., *The Parrett Catchment: A case study to develop tools and methodologies to deliver an Ecosystems Approach (Catchment Futures)*. 2008. <http://randd.defra.gov.uk/Default.aspx?Menu=Menu&Module=More&Location=None&Completed=0&ProjectID=14756#Description>
393. Houghton, A.J., D.A. Bohan, S.J. Clark, M.D. Mallott, et al., *Dedicated biomass crops can enhance biodiversity in the arable landscape*. *GCB Bioenergy*, 2016. **8**(6): p. 1071-1081.
394. DEFRA, *Single departmental plan: 2015 to 2020*. 2016. [www.gov.uk/government/publications/defra-single-departmental-plan-2015-to-2020/single-departmental-plan-2015-to-2020](http://www.gov.uk/government/publications/defra-single-departmental-plan-2015-to-2020/single-departmental-plan-2015-to-2020)



# Appendix 1: List of working group members and external reviewers

## Working group members

### Chair

**Professor Adisa Azapagic FREng**, Professor of Sustainable Chemical Engineering, The University of Manchester

### Members

**Professor Jim Hall FREng**, Director, Environmental Change Institute and Professor of Climate and Environmental Risks, University of Oxford; Adaptation Subcommittee of the Committee on Climate Change

**Dr Rebecca Heaton**, Head of Sustainability and Policy at Drax Power; Member of the Committee on Climate Change

**Professor Roger Kemp MBE FREng**, Professorial Fellow, Lancaster University

**David Lemon**, David Lemon Consultants, UK

**Professor Raffaella Ocone FREng FRSE**, Professor of Chemical Engineering, School of Engineering and Physical Sciences, Heriot-Watt University

**Professor Nilay Shah FREng**, Professor of Process Systems Engineering and Director, Centre for Process Systems Engineering (CPSE), Head of the Department of Chemical Engineering, Imperial College London

**Professor Pete Smith FRSB FRSE**, Professor of Soils and Global Change, Institute of Biological and Environmental Sciences, University of Aberdeen

**Professor Joshua Swithenbank FREng**, Emeritus Professor of Chemical Engineering and Fuel Technology, Department of Chemical and Biochemical Engineering, University of Sheffield; Chairman: University of Sheffield Waste Incineration Centre; Energy and Environment Engineering

## Staff

### Lead authors

**Dr Andrew Chilvers**, Policy Advisor, Royal Academy of Engineering

**Dr Harish Jeswani**, Research Fellow, School of Chemical Engineering and Analytical Science, The University of Manchester

### Supporting staff

**Beverley Parkin**, Director, Policy and External Affairs, Royal Academy of Engineering

**Dr Alan Walker**, Head of Policy, Royal Academy of Engineering

**Chenel Marshall**, Policy Officer, Royal Academy of Engineering

## External reviewers

**Dr Ausilio Bauen**, Senior Research Fellow, Centre for Environmental Policy, Imperial College, London and Director, E4tech Consulting, UK

**Dr Helena Chum**, Research Fellow, National Renewable Energy Laboratory, USA

**Dr Rick Jefferys FREng**, Former Director of Strategy and Technology, ConocoPhillips Company, Alternative Energy Group, London; Senior Research Engineer, Mechanical Engineering, University of Edinburgh, UK

**Professor Sanette Marx**, South Africa's National Research Foundation Chair in Biofuels, North-West University, South Africa

**Dr Jeanette Whitaker**, Plant-Soil Ecologist, Centre for Ecology and Hydrology, Lancaster University, UK

# Appendix 2: Terms of reference

## Sustainability issues associated with liquid biofuels

### Project summary

The aim of this study is to better understand the carbon footprint of liquid biofuels and to investigate current understanding of other sustainability issues involved in their production, supply and use.

### Project rationale

Liquid biofuels currently make up a relatively small but important proportion of primary fuel supplies in the UK. However, with legislation requiring wholesale cuts in greenhouse gas emissions, this is likely to increase. There is a lack of low-carbon alternative sources of fuel in sectors such as aviation, marine, defence and heavy duty transport. While better traffic management and other efficiency gains are foreseeable in these sectors, there will be a continued need for low-carbon liquid fuels with high energy densities if these sectors are to successfully reduce greenhouse gas emissions. As a result, there are significant international efforts to develop viable liquid biofuel markets and industries.

If biofuels are to be used more, it is important that they deliver in terms of reducing greenhouse gas emissions. The key aim of this study will therefore be to better understand the carbon footprint from the production, supply and use of liquid biofuels and its co-products. In addition, there are wider sustainability issues that may need to be anticipated and mitigated, for example, conflicts of land use and other associated issues in the production of biofuels such as water use, soil erosion, impacts on biodiversity and production and transport infrastructure. There are also some significant economic opportunities that need to be analysed and appraised such as greater national energy security, new uses for waste streams from certain sectors such as agriculture, and better utilisation of marginal land.

### Scope

The study will focus on:

- liquid biofuels currently used in the UK, either produced indigenously or imported
- emerging advanced liquid biofuels proposed for large-scale production in the UK.

The carbon footprint of these biofuels will be the primary focus of the study. This will include an assessment of current life-cycle assessment (LCA) methodologies and standards with a focus on greenhouse gas emissions, energy requirements and land-use changes. The assessment will include consideration of co-products related to the production of biofuels.

Broader sustainability issues, incorporating economic, social and other environmental aspects, will be identified and analysed. An assessment will also be made of the potential level of supply that the UK could sustain in the future, including from advanced, next generation biofuels.

Given the international nature of the trade in biofuels, the project will seek to draw on similar work underway internationally, for example, research funded by the Australian Renewable Energy Agency (ARENA).

---

## Project work plan

A working group (WG) will be established under the auspices of the Engineering Policy Committee. It will be chaired by a Fellow of the Academy and include up to seven experts in the field, with at least three Fellows. The work shall be directed and overseen by the WG but mainly carried out by the policy team of the Academy. Government funding will be used to employ an additional researcher with experience in the field to carry out specific research or drafting tasks.

The general sequence of work will be as follows:

- As this is primarily a metastudy of available knowledge, a comprehensive literature review will be conducted on:
  - current LCA methodologies applicable to the appraisal of liquid biofuels
  - LCA and sustainability studies that have been conducted on liquid biofuels to date.
- An open call for evidence will be issued. This will be followed by panel sessions at which oral evidence will be provided to the WG. Interviews will also be conducted with relevant stakeholders from industry, academia and government as needed.
- A report will be produced that draws together the findings of the literature review, expert evidence, stakeholder interviews as well as the insights and recommendations of the WG.
- The complete report will be subject to the Academy's quality control process and will be reviewed according to Academy procedures.
- The final decision to publish will be made by the Academy's Engineering Policy Committee.



# Appendix 3: Summary of stakeholder input

## Written evidence

A stakeholder mapping exercise was conducted and an open call for written evidence was issued and disseminated internationally on 21 March 2016. The call was also made public on the Academy's website, promoted through its Fellowship and circulated throughout the International Council of Academies of Engineering and Technological Sciences (CAETS) Network<sup>1</sup>. The call remained open until 2 May 2016 and 37 submissions of varying length were received.

## Oral evidence

Six oral evidence sessions were held whereby the study's expert working group questioned panels of four to six stakeholders. These sessions were used to either follow up with stakeholders who had submitted written evidence or as an opportunity to consult key stakeholders who had not participated in the call for written evidence. Although participants were free to raise any items of discussion they wished, each session grouped particular stakeholders together to promote discussion on particular topics. The panels were structured around: feedstocks for first generation biofuels; feedstocks for advanced biofuels; biofuel producers; biofuel user groups; and cross-cutting issues.

## International input

In order to test the predominantly UK-focused perspectives that had been gained in the oral evidence sessions and interviews, three teleconferences were held with panels of experts from Australia, Brazil and the U.S.

## Summary of input

Name	Type of input (Written - W, Oral - O, Both -W&O)
<b>Governmental bodies</b>	
Australian Renewable Energy Agency (ARENA)	O
<b>Associations and Partnerships</b>	
Bioenergy Australia	O
C1net	W
Low Carbon Vehicles Partnership (LowCVP)	W
National Farmers Union (NFU)	W&O
Renewable Energy Association	W&O
Seed Crushers and Oil Processors Association (SCOPA)	W&O
Society and Motor Manufacturers and Traders (SMMT)	W
Sustainable Aviation	W&O
UK Liquid Petroleum Gas	W
UNICA, Brazil	W
<b>Professional Institutions</b>	
Institute of Marine Engineering, Science and Technology (IMarEST)	W&O
Royal Aeronautical Society	W

*continued over*

<sup>1</sup> International network of national academies focused on engineering and technological sciences ([www.caets.org/](http://www.caets.org/)).

Australian Academy of Technological Sciences and Engineering	W&O
National Academy of Engineering, USA	W
<b>Individual companies</b>	
Argent Energy	O
Bioetanol, Brazil	O
C3 Bio-technologies	W
Edge Environmental	W&O
FiveBarGate Consulting Ltd	W&O
FSK Technology Research	W
Graeme Pearman Consulting	W&O
Greenergy	W&O
Ingenza	W
Life Cycle Strategies	W&O
Lloyd's Register (Marine)	O
National Non-Food Crops Centre (NNFCC)	O
North Energy Associates	O
Shell International Petroleum Company	W&O
Velocys	W
Virgin Australia	O
Vivergo Fuel	W&O
NesteOil	W
<b>Academia and research</b>	
Lignocellulosic Biorefinery Network (LBNNet)	W&O
SUPERGEN Bioenergy Hub	W
Heriot-Watt University	W
The Industrial Biotechnology Innovation Centre (IBioIC)	W
Argonne National Laboratory, USA	W
National Renewable Energy Laboratory, USA	W
Professor Geoffrey Hammond, University of Bath	W
Professor Nick Hewitt, Lancaster Environment Centre	W
Dr Rick Jefferys FREng, Mechanical Engineering, University of Edinburgh	W
Robert Matthews, Programme Group Manager, Centre for Forest Resources and Management, Forest Research	O
Professor Susan Pond AM FTSE, Consultant and Adjunct Professor in Sustainability, Alternative Transport Fuels Initiative at the United States Studies Centre	O
Dr Paulo Saldiva, University of São Paulo, Brazil	O
Professor Joaquim Seabra, University of Campinas, Brazil	O
Dr Raphael Slade, Imperial College, London	O

Dr Patricia Thornley, Tyndall Centre, The University of Manchester	0
Dr Paul Upham, Centre for Integrated Energy Research and Sustainability Research Institute, University of Leeds	W
Professor Graeme Walker, Abertay University	W
Dr Jeremy Woods, Imperial College, London	0
Dr Christina Canter, Argonne National Laboratory, USA	0
Ethan Warner, National Renewable Energy Laboratory, USA	0
Dr Rebecca Efroymsen, Oak Ridge National Laboratory, USA	0
Keith Kline, Oak Ridge National Laboratory, USA	0
Dr Robert Brown, Iowa State University	0
<b>Non-governmental organisations (NGOs)</b>	
Greenpeace	0
WWF	0



# Appendix 4: Carbon footprint of biofuels (supplementary information)

**Figure A1**  
Carbon footprint values for first generation bioethanol reported in LCA studies

[Based on data from [98,99,111,156,171,172,174,178-201]. Values in this figure were used to generate plots in Figure 5. LUC: land-use change].

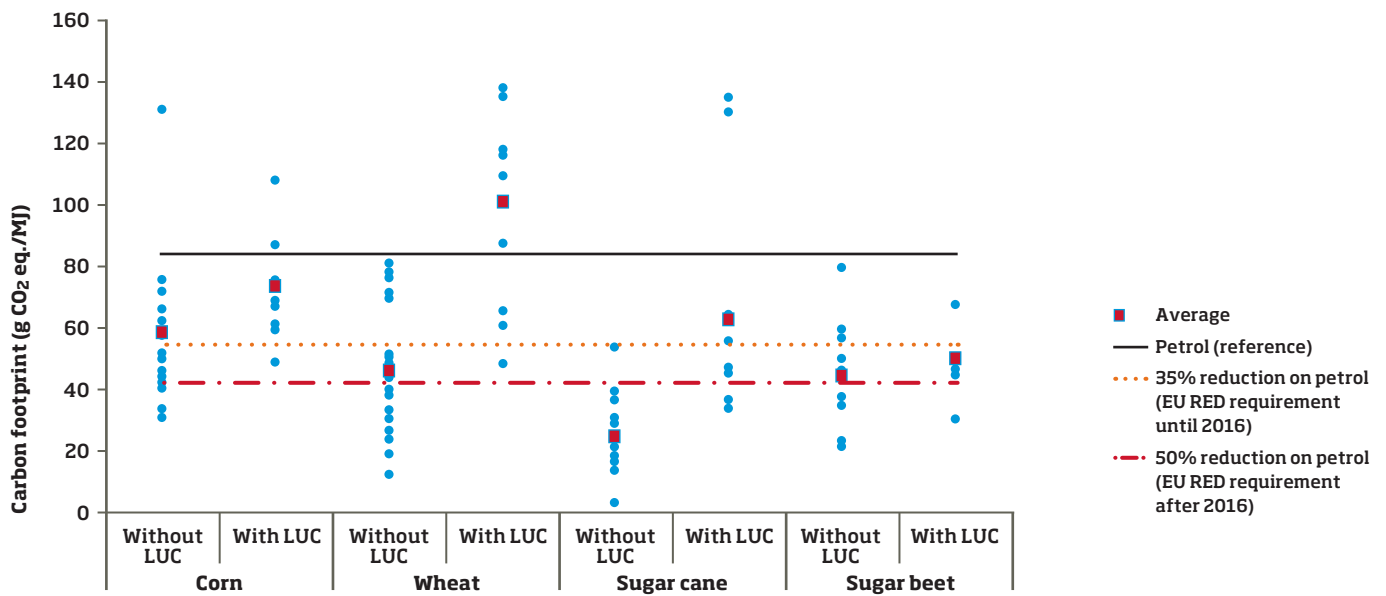

**Figure A2**  
Carbon footprint values for first generation biodiesel reported in LCA studies

[Based on data from [25,99,156,172,175,177,184,190,197,201,203-230]. Values in this figure were used to generate plots in Figure 6. LUC: land-use change].

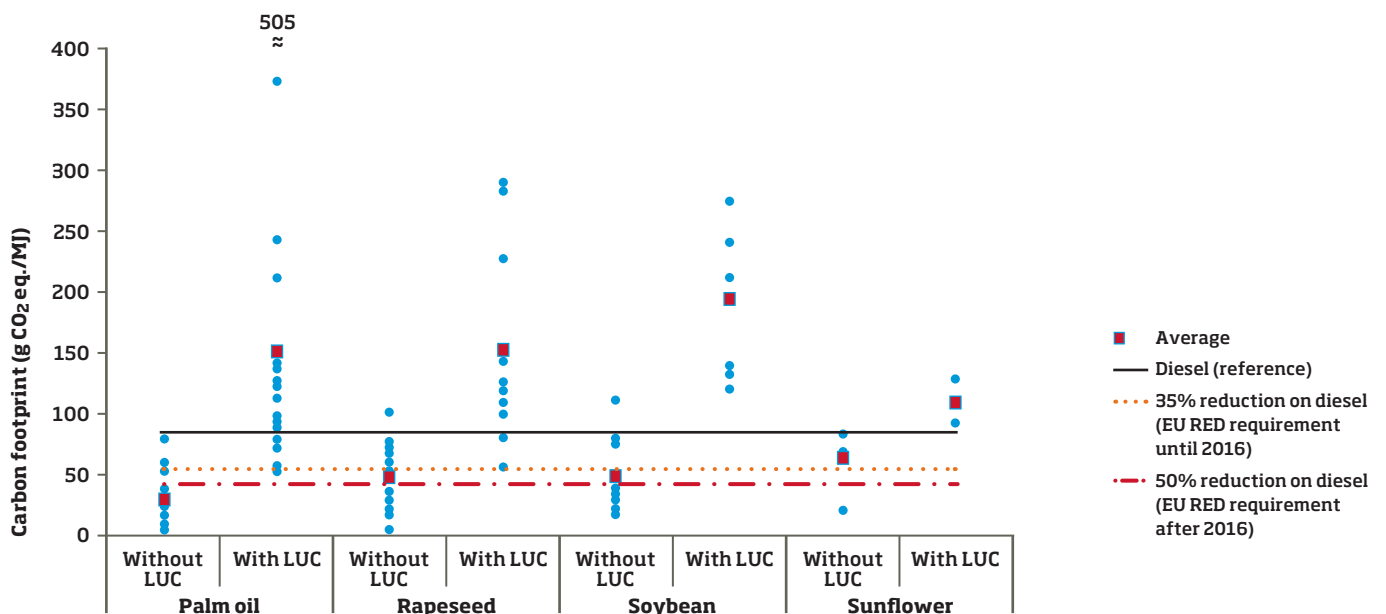

**Figure A3**  
Carbon footprint values for second generation bioethanol reported in LCA studies

[Based on data from <sup>[61,62,96,97,111,154,171,174,178,181,195,198,231,232,239-265]</sup>. Values in this figure were used to generate plots in [Figure 7.](#)]

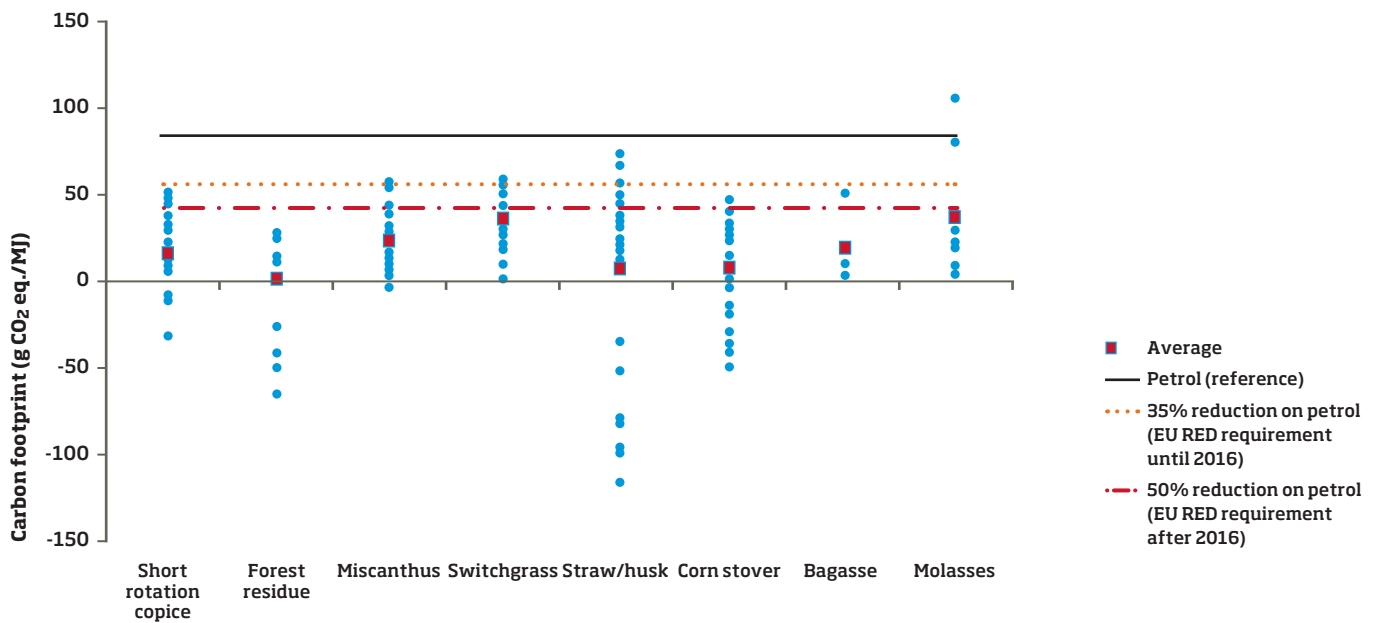

**Figure A4**  
Carbon footprint values for second generation biodiesel reported in LCA studies

[Based on data from <sup>[184,203,209,227,237,238,270-283]</sup>. Values in this figure were used to generate plots in [Figure 8.](#)]

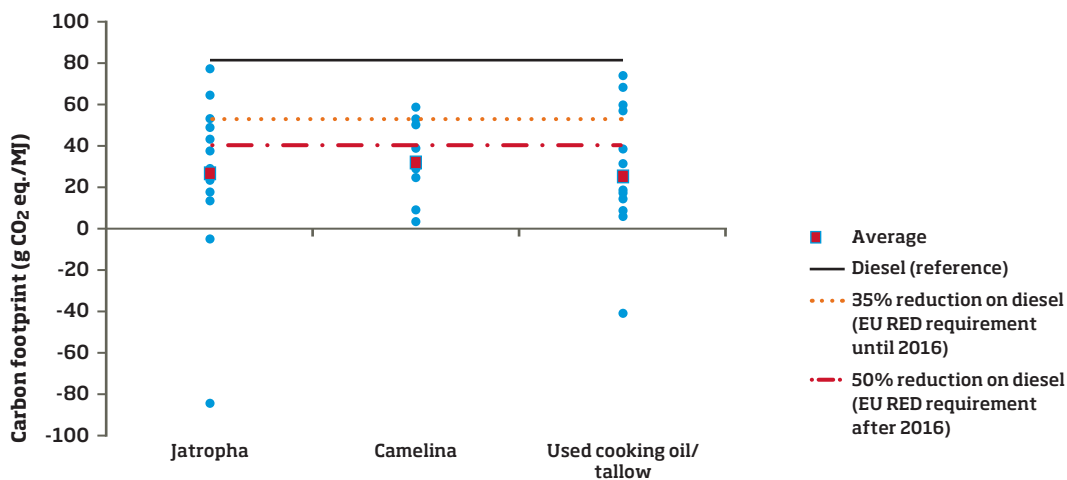

**Figure A5**  
Carbon footprints for algae biodiesel

[Based on data from [45,159,194,227,248,264,268,269,273,284-293], Values in this figure were used to generate plots in Figure 9.]

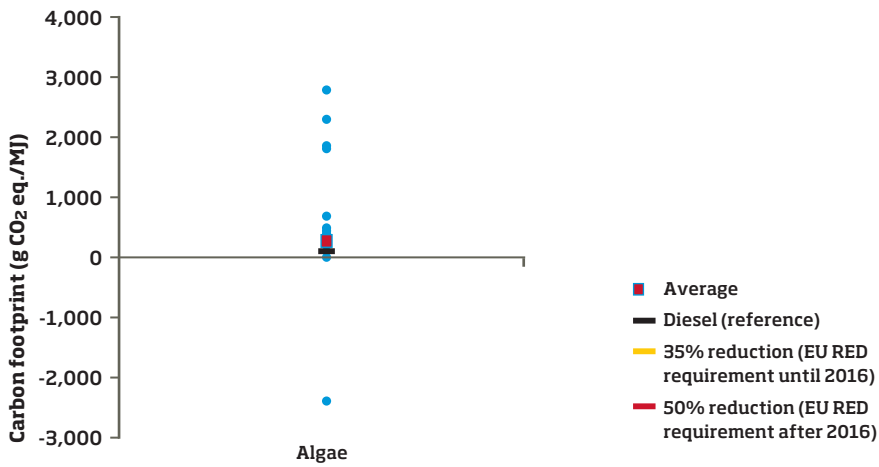

**Figure A6**  
Fossil energy use in the life cycle of biofuels

[Based on data from [45,61,62,96,97,159,171,174,175,181,182,184,187-189,193-195,203,205,211,217,219,220,226,228,229,232,238-240,243,245,246,250,251,254,259,260,262,264,265,269-273,275,276,280,281,284-289,297-301], Values in this figure were used to generate plots in Figure 10. The red squares represent the average values across the studies. Values for 3rd generation biodiesel should be multiplied by 10 to obtain the actual value].

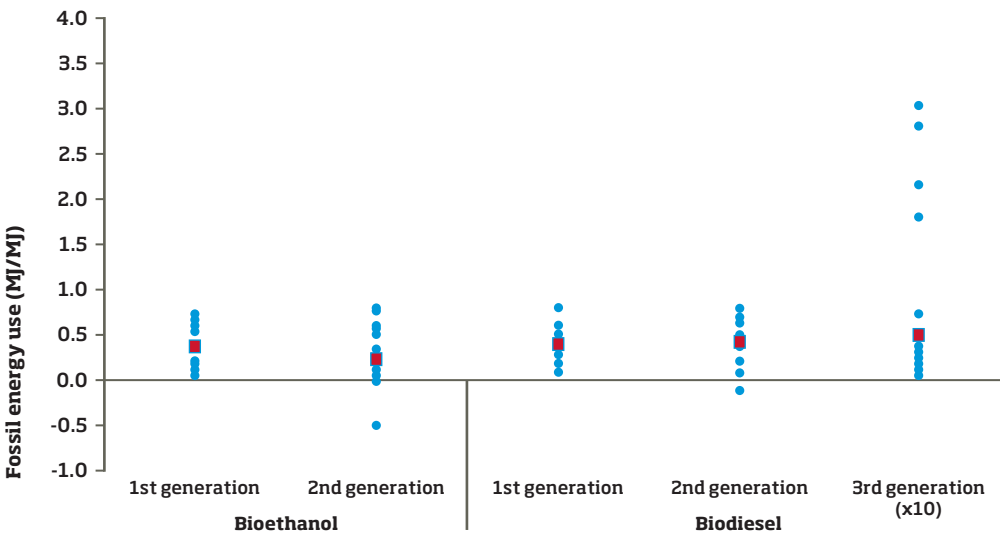



**Table A1**  
Overview of the findings of LCA studies for the carbon footprints of biofuels

Biofuel type	Feedstocks	No. of papers	No. of analyses (studies)	Carbon footprint range (g CO <sub>2</sub> eq./MJ)	Average carbon footprint (g CO <sub>2</sub> eq./MJ)	Geographic spread (based on number of studies)	Percentage of analyses (sample size) meeting reduction in GHG emissions relative to fossil fuels (%)	Percentage of analyses (sample size) meeting 50% reduction GHG emissions relative to fossil fuels (%)	
1st generation bioethanol	Corn	no LUC	8	16	31-131	59	USA (94%); China (6%)	50	19
		with LUC	4	14	49-108	73	USA (57%); Denmark (43%)	7	0
	Wheat	no LUC	10	27	13-81	46	UK (41%); Germany (34%); Spain (10%); Denmark 7%); Spain (10%); France (4%); Belgium (4%)	81	14
		with LUC	4	11	48-138	101	Denmark (54%); UK (36%); France (10%)	9	0
	Sugar cane	no LUC	13	20	4-54	25	Brazil (75%); India (10%); Mexico (10%);	100	95
		with LUC	4	10	34-135	62	South Africa (5%); Brazil (70%); Mexico (30%)	60	40
	Sugar beet	no LUC	6	12	22-80	44	Germany (50%); France (33%); Belgium (8%); South Africa (8%)	75	42
		with LUC	2	7	31-68	50	Denmark (86%); France (14%)	71	14
	Palm oil	no LUC	15	24	3-81	30	Malaysia (50%); Indonesia (25%); Colombia (12%); Thailand (12%)	75	71
		with LUC	6	20	53-505	151	Malaysia (70%); Indonesia (30%)	5	0
	Rape-seed	no LUC	14	22	4-101	47	USA (18%); Portugal (18%); Denmark (14%); UK (9%); Germany (9%); Spain (9%); Others (23%)	68	45
		with LUC	8	10	56-287	152	Portugal (20%); South Africa (20%); EU (20%); UK (10%); Spain (10%); Denmark (10%); Chile (10%)	0	0
	Soybean	no LUC	9	14	18-111	48	USA (50%); China (21%); South Africa (14%); Brazil (7%); Spain (7%)	71	57
		with LUC	6	7	120-274	194	Brazil (43%); Argentina (43%); South Africa (14%)	0	0
	Sun-flower	no LUC	4	5	19-83	63	South Africa (60%); Italy (20%); Chile (20%)	20	20
		with LUC	1	2	91-129	110	South Africa (100%)	0	0

*continued over*

Biofuel type	Feedstocks	No. of papers	No. of analyses (studies)	Carbon footprint range (g CO <sub>2</sub> eq./MJ)	Average carbon footprint (g CO <sub>2</sub> eq./MJ)	Geographic spread (based on number of studies)	Percentage of analyses (sample size) meeting reduction in GHG emissions relative to fossil fuels (%)	Percentage of analyses (sample size) meeting 50% reduction GHG emissions relative to fossil fuels (%)
2nd generation bioethanol	Short rotation coppice	13	31	-31-50	17	Spain (23%); Denmark (19%); UK (16%); Italy (16%); USA (6%); others (19%)	100	87
	Forest residue	7	15	-64-28	2	USA (27%); Denmark (27%); UK (20%); Sweden (13%); others (13%)	100	100
	Miscanthus	6	17	-1-58	24	USA (53%); Denmark (35%); UK (12%)	88	76
	Switchgrass	8	20	2-58	36	USA (85%); others (15%)	80	55
	Straw/husk	13	26	-115-47	8	UK (31%); Denmark (27%); India (12%); Italy (8%); others (22%)	88	73
	Stover	9	22	-49-47	7	USA (73%); Denmark (27%)	100	91
	Bagasse	3	4	4-52	20	Brazil (50%); India (50%); USA (25%)	100	75
	Molasses	6	8	3-105	36	Australia (50%); India (25%); Brazil (13%); Mexico (12%)	75	75
	Jatropha	9	14	-88-80	27	Africa (36%); India (29%); China (21%); Mexico (14%)	86	64
	Camelina	2	10	33-60	3	USA (60%); Canada (40%)	88	70
	Used cooking oil	12	18	-43-75	26	Ireland (28%); Portugal (22%); Spain (17%); Brazil (11%); Thailand (11%); UK (6%); China (6%)	78	78
3rd generation biodiesel	Algae	20	42	-2400-2900	290	USA & Canada (55%); Europe (20%); S. America (10%); India (10%); Australia (5%)	31	26







# ROYAL ACADEMY OF ENGINEERING

## **Royal Academy of Engineering**

As the UK's national academy for engineering, we bring together the most successful and talented engineers for a shared purpose: to advance and promote excellence in engineering.

We have four strategic challenges:

### **Drive faster and more balanced economic growth**

To improve the capacity of UK entrepreneurs and enterprises to create innovative products and services, increase wealth and employment and rebalance the economy in favour of productive industry.

### **Foster better education and skills**

To create a system of engineering education and training that satisfies the aspirations of young people while delivering the high-calibre engineers and technicians that businesses need.

### **Lead the profession**

To harness the collective expertise, energy and capacity of the engineering profession to enhance the UK's economic and social development.

### **Promote engineering at the heart of society**

To improve public understanding of engineering, increase awareness of how engineering impacts on lives and increase public recognition for our most talented engineers.



Royal Academy of Engineering  
Prince Philip House  
3 Carlton House Terrace  
London SW1Y 5DG

Tel: +44 (0)20 7766 0600  
[www.raeng.org.uk](http://www.raeng.org.uk)

Registered charity number 293074



This brochure can be recycled.